



Section 2

Galvanised Malleable Iron Pipe Fittings

Edition 3

Specifications

STANDARD AND IDENTIFICATION:

Standard for production and use EN 10242 : 1994

Fittings made of high quality blackheart malleable cast iron to ASTM A-197, ASTM A47

THREADS: The threads are cut according to AS 1722.1 / ISO 7/1. Parallel internal thread (RP) and tapered external thread (R).

APPLICATION: All the fittings are adequate for the supply of water at recommended maximum working pressure of 1379kPa and gas, steam and compressed air at recommended maximum working pressure of 1034 kPa. Note: Working pressures may also be limited by relevant pressure piping codes or Industry regulations.

DIMENSIONS: All the fittings are manufactured to the specifications of standard BS EN 10242, BS 143, BS 1256

INSPECTION: All the fittings are inspected for conformity with the specifications of standard EN 10242.

MARKING: All the fittings, when possible, are marked with brand and/or with the nominal size Identification.

HOT DIP: The fittings are delivered in hot dip galvanised finish, as prescribed by the standard EN 10242.

LEAK TEST: Applying the standard EN 10242 each individual fitting is subjected to a pressure test with a min. Hydrostatic pressure of 2068 kPa, which is equivalent to a pneumatic pressure of min. 500 kPa, without showing any sign of leakage or abnormality.

BRITISH STANDARD THREADS							
All measurements in mm							
NOMINAL BORE OF PIPE		APPROX. OUTSIDE DIAMETER	NUMBER OF THREADS PER INCH	PITCH	DEPTH OF THREADS	DIAMETER AT GAUGE PLANE	LENGTH OF USEFUL THREAD
IMPERIAL	METRIC	A		P	h	B	E
1/8	6	10.16	28	0.907	0.581	9.72	6.5
1/4	8	13.66	19	1.337	0.856	13.15	9.7
3/8	10	17.17	19	1.337	0.856	16.66	10.1
1/2	15	21.51	14	1.814	1.162	20.95	13.2
3/4	20	27.00	14	1.814	1.162	26.44	14.5
1	25	33.93	11	2.309	1.479	33.24	16.8
1 1/4	32	42.59	11	2.309	1.479	41.91	19.1
1 1/2	40	48.48	11	2.309	1.479	47.80	19.1
2	50	60.47	11	2.309	1.479	59.61	23.4
2 1/2	65	76.09	11	2.309	1.479	75.18	26.7
3	80	88.87	11	2.309	1.479	87.88	29.8
4	100	114.14	11	2.309	1.479	113.03	35.8
5	125	139.65	11	2.309	1.479	138.43	40.1
6	150	165.12	11	2.309	1.479	163.83	40.1

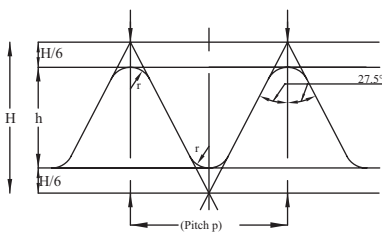

Fig. 1. (Parallel)
 $H = 0.960491 \times p$
 $h = 0.640327 \times p$
 $r = 0.137329 \times p$

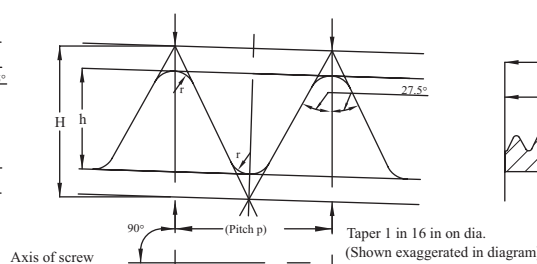

Fig. 2. (Taper)
 $H = 0.960237 \times p$
 $h = 0.640327 \times p$
 $r = 0.137278 \times p$

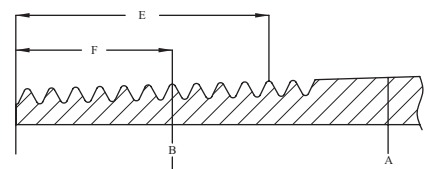
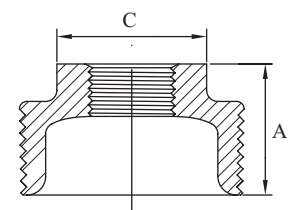
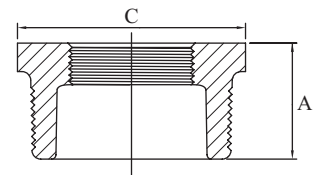

Fig. 3. (Taper)

Galvanised Malleable Hexagon Bush

Galvanised Malleable Hexagon Bush				
AAP CODE	IMPERIAL SIZE	A	C	APPROX KG/PC
LB0806	1/4 X 1/8	17.0	16.3	0.01
LB1006	3/8 X 1/8	16.3	21.6	0.02
LB1008	3/8 X 1/4	16.3	21.1	0.02
LB1508	1/2 X 1/4	19.0	26.2	0.04
LB1510	1/2 X 3/8	19.0	26.2	0.03
LB2008	3/4 X 1/4	21.6	29.2	0.06
LB2010	3/4 X 3/8	21.6	29.2	0.06
LB2015	3/4 X 1/2	23.6	29.2	0.05
LB2508	1 X 1/4	28.7	28.5	0.09
LB2510	1 X 3/8	28.7	28.5	0.08
LB2515	1 X 1/2	28.0	36.1	0.09
LB2520	1 X 3/4	28.0	36.1	0.08
LB3210	1-1/4 X 3/8	31.4	28.5	0.13
LB3215	1-1/4 X 1/2	31.4	31.5	0.14
LB3220	1-1/4 X 3/4	27.4	44.7	0.16
LB3225	1-1/4 X 1	27.4	44.7	0.13
LB4015	1-1/2 X 1/2	33.0	34	0.17
LB4020	1-1/2 X 3/4	33.0	36.5	0.18
LB4025	1-1/2 X 1	31.2	50.8	0.21
LB4032	1-1/2 X 1-1/4	31.2	50.8	0.15
LB5015	2 X 1/2	35.3	34.0	0.26
LB5020	2 X 3/4	35.3	41.4	0.29
LB5025	2 X 1	35.3	45.0	0.30
LB5032	2 X 1-1/4	38.0	63.0	0.34
LB5040	2 X 1-1/2	38.0	63.0	0.28
LB6525	2-1/2 X 1	38.4	49.5	0.44
LB6532	2-1/2 X 1-1/4	38.4	60.7	0.47
LB6540	2-1/2 X 1-1/2	38.4	75.7	0.53
LB6550	2-1/2 X 2	39.1	75.7	0.46
LB8025	3 X 1	40.9	49.5	0.64
LB8032	3 X 1-1/4	40.9	60.7	0.64
LB8040	3 X 1-1/2	40.9	68.1	0.69
LB8050	3 X 2	40.9	98.0	0.78
LB8065	3 X 2-1/2	40.9	98.0	0.76
LB9440	4 X 1-1/2	46.2	68.1	1.09
LB9450	4 X 2	51.2	83.3	1.14
LB9465	4 X 2-1/2	46.2	98.1	1.30
LB9480	4 X 3	51.0	126.0	1.34
LB9694	6 X 4	59.1	147.1	3.22



Galvanised Malleable Female-Female Elbow 90 Degree

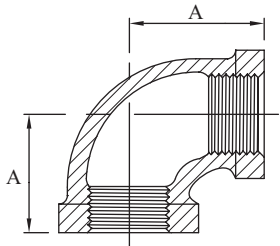

Galvanised Malleable Female-Female Elbow 90 Degree			
AAP CODE	IMPERIAL SIZE	A	APPROX KG/PC
LE06	1/8	17.5	0.03
LE08	1/4	20.6	0.05
LE10	3/8	24.1	0.1
LE15	1/2	28.5	0.1
LE20	3/4	33.3	0.2
LE25	1	38.1	0.3
LE32	1-1/4	44.5	0.4
LE40	1-1/2	49.3	0.6
LE50	2	57.2	0.8
LE65	2-1/2	68.6	1.5
LE80	3	78.2	2.3
LE94	4	96.3	4.1
LE96	6	130.3	10.7

Galvanised Malleable Female-Female Reducing Elbow 90 Degree

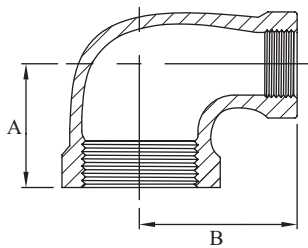

Galvanised Malleable Female-Female Reducing Elbow 90 Degree				
AAP CODE	IMPERIAL SIZE	A	B	APPROX KG/PC
LE1510	1/2 X 3/8	26.4	26.2	0.09
LE2010	3/4 X 3/8	28.5	28.7	0.12
LE2015	3/4 X 1/2	30.5	31.0	0.14
LE2510	1 X 3/8	31.0	32.1	0.16
LE2515	1 X 1/2	32.0	35.5	0.20
LE2520	1 X 3/4	34.8	36.8	0.23
LE3215	1-1/4 X 1/2	34.0	38.9	0.27
LE3220	1-1/4 X 3/4	36.8	41.2	0.30
LE3225	1-1/4 X 1	40.1	42.4	0.37
LE4015	1-1/2 X 1/2	35.0	42.0	0.33
LE4020	1-1/2 X 3/4	38.6	44.5	0.39
LE4025	1-1/2 X 1	41.9	45.7	0.43
LE4032	1-1/2 X 1-1/4	46.2	47.8	0.51
LE5015	2 X 1/2	37.6	47.5	0.47
LE5020	2 X 3/4	40.6	50.0	0.54
LE5025	2 X 1	43.9	51.3	0.58
LE5032	2 X 1-1/4	48.3	53.3	0.71
LE5040	2 X 1-1/2	51.3	54.9	0.76
LE8065	3 X 2-1/2	71.9	75.9	2.10

Galvanised Malleable Male-Female Elbow 90 Degree

Galvanised Malleable Male-Female Elbow 90 Degree				
AAP CODE	IMPERIAL SIZE	A	B	APPROX KG/PC
LEMF08	1/4	20.2	29.6	0.05
LEMF10	3/8	24.1	37.6	0.07
LEMF15	1/2	27.9	40.4	0.10
LEMF20	3/4	32.6	47.0	0.18
LEMF25	1	37.3	53.3	0.27
LEMF32	1-1/4	44.5	65.2	0.43
LEMF40	1-1/2	48.3	66.9	0.62
LEMF50	2	56.1	81.1	1.02
LEMF65	2-1/2	67.2	96.0	1.51
LEMF80	3	76.6	112.3	2.39
LEMF94	4	94.4	141.6	4.06

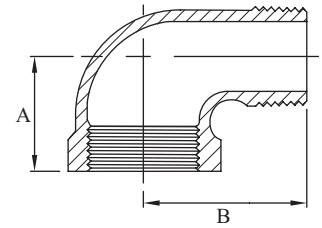

Galvanised Malleable Male-Female Elbow 45 Degree

Galvanised Malleable Male-Female Elbow 45 Degree				
AAP CODE	IMPERIAL SIZE	A	B	APPROX KG/PC
LEMFF15	1/2	21.9	33.0	0.09
LEMFF20	3/4	24.4	37.5	0.13
LEMFF25	1	27.9	43.0	0.22
LEMFF32	1-1/4	32.1	47.4	0.32
LEMFF40	1-1/2	35.6	52.0	0.46
LEMFF50	2	41.8	60.4	0.76

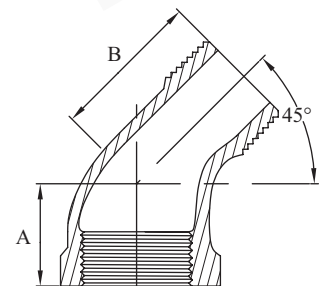

Galvanised Malleable Equal Tee

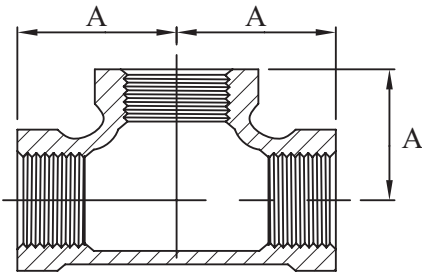

Galvanised Malleable Equal Tee			
AAP CODE	IMPERIAL SIZE	A	APPROX KG/PC
LT06	1/8	17.5	0.05
LT08	1/4	20.6	0.07
LT10	3/8	24.1	0.10
LT15	1/2	28.5	0.16
LT20	3/4	33.3	0.22
LT25	1	38.1	0.38
LT32	1-1/4	44.5	0.59
LT40	1-1/2	49.3	0.75
LT50	2	57.3	0.01
LT65	2-1/2	68.6	2.02
LT80	3	78.2	3.05
LT94	4	96.3	5.13
LT96	6	119.3	9.6

Galvanised Malleable Hexagon Nipple

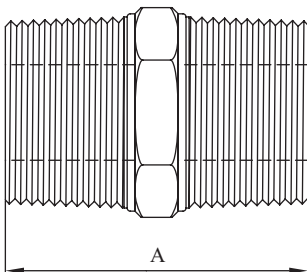

Galvanised Malleable Hexagon Nipple			
AAP CODE	IMPERIAL SIZE	A	APPROX KG/PC
LN06	1/8	30.2	0.01
LN08	1/4	38.0	0.03
LN10	3/8	39.0	0.04
LN15	1/2	44.7	0.07
LN20	3/4	49.3	0.11
LN25	1	54.2	0.19
LN32	1-1/4	57.1	0.28
LN40	1-1/2	60.0	0.34
LN50	2	69.3	0.54
LN65	2-1/2	73.2	0.50
LN80	3	83.3	0.83
LN94	4	96.7	1.16
LN96	6	117.5	3.00

Galvanised Malleable Hexagon Reducing Nipple

Galvanised Malleable Hexagon Reducing Nipple			
AAP CODE	IMPERIAL SIZE	A	APPROX KG/PC
LN0806	1/4 X 1/8	32	0.02
LN1006	3/8 X 1/8	38	0.03
LN1008	3/8 X 1/4	38	0.03
LN1508	1/2 X 1/4	44	0.05
LN1510	1/2 X 3/8	44	0.05
LN2010	3/4 X 3/8	47	0.1
LN2015	3/4 X 1/2	47	0.1
LN2515	1 X 1/2	53	0.12
LN2520	1 X 3/4	53	0.12
LN3215	1-1/4 X 1/2	57	0.22
LN3220	1-1/4 X 3/4	57	0.22
LN3225	1-1/4 X 1	57	0.22
LN4015	1-1/2 X 1/2	59	0.3
LN4020	1-1/2 X 3/4	59	0.3
LN4025	1-1/2 X 1	59	0.3
LN4032	1-1/2 X 1-1/4	59	0.3
LN5015	2 X 1/2	68	0.4
LN5020	2 X 3/4	68	0.4
LN5025	2 X 1	68	0.42
LN5032	2 X 1-1/4	68	0.42
LN5040	2 X 1-1/2	68	0.42
LN6540	2-1/2 X 1-1/2	75	0.69
LN6550	2-1/2 X 2	75	0.69
LN8050	3 X 2	83	1
LN8065	3 X 2-1/2	83	1
LN9450	4 X 2	92	1.42
LN9465	4 X 2-1/2	92	1.42
LN9480	4 X 3	92	1.42

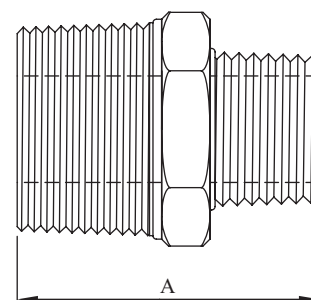

Galvanised Malleable Female-Female Elbow 45 Degree

Galvanised Malleable Female-Female Elbow 45 Degree			
AAP CODE	IMPERIAL SIZE	A	APPROX KG/PC
LEF15	1/2	22.4	0.10
LEF20	3/4	24.9	0.15
LEF25	1	28.5	0.23
LEF32	1-1/4	32.8	0.33
LEF40	1-1/2	36.3	0.46
LEF50	2	42.7	0.70
LEF65	2-1/2	49.5	1.26
LEF80	3	55.1	2.04
LEF94	4	66.3	3.38

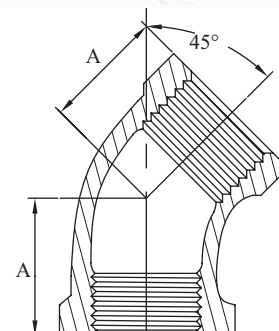

Galvanised Malleable Reducing Tee

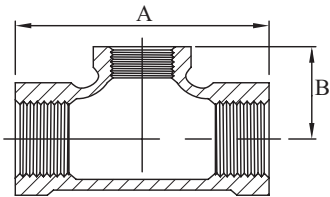

Galvanised Malleable Reducing Tee				
AAP CODE	IMPERIAL SIZE	A	B	APPROX KG/PC
LT2015	3/4 X 1/2	59.0	29.0	0.17
LT2510	1 X 3/8	61.5	30.5	0.26
LT2515	1 X 1/2	62.6	31.8	0.22
LT2520	1 X 3/4	70.0	36.7	0.25
LT252020	1 X 3/4 X 3/4	68.0	35.7	0.43
LT2532	1 X 1-1/4	85.0	39.0	0.43
LT2540	1 X 1-1/2	91.5	41.0	0.50
LT3215	1-1/4 X 1/2	65.7	37.5	0.30
LT3220	1-1/4 X 3/4	74.2	42.0	0.43
LT3225	1-1/4 X 1	78.3	41.5	0.38
LT322515	1-1/4 X 1 X 1/2	66.3	38.0	0.33
LT322525	1-1/4 X 1 X 1	80.0	40.0	0.46
LT322532	1-1/4 X 1 X 1-1/4	87.0	45.0	0.50
LT3240	1-1/4 X 1-1/2	100.0	46.0	0.60
LT3250	1-1/4 X 2	108.0	48.0	0.65
LT4015	1-1/2 X 1/2	69.7	41.0	0.37
LT4020	1-1/2 X 3/4	74.4	42.0	0.46
LT4025	1-1/2 X 1	74.4	45.0	0.50
LT4032	1-1/2 X 1-1/4	93.0	48.5	0.68
LT403225	1-1/2 X 1-1/4 X 1	82.7	46.5	0.53
LT4050	1-1/2 X 2	110.0	49.0	0.88
LT5015	2 X 1/2	74.7	48.0	0.55
LT5020	2 X 3/4	80.0	49.0	0.60
LT5025	2 X 1	88.9	56.0	0.85
LT5032	2 X 1-1/4	98.4	51.0	0.95
LT5040	2 X 1-1/2	109.4	52	0.86
LT5065	2 X 2-1/2	129.0	57.0	1.40
LT8050	3 X 2	126.0	70.0	1.83

Galvanised Malleable Cap

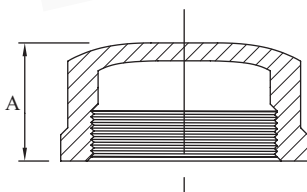

Galvanised Malleable Cap			
AAP CODE	IMPERIAL SIZE	A	APPROX KG/PC
LC08	1/4	16.0	0.03
LC10	3/8	18.8	0.04
LC15	1/2	22.1	0.06
LC20	3/4	24.6	0.08
LC25	1	29.5	0.14
LC32	1-1/4	32.5	0.21
LC40	1-1/2	33.8	0.30
LC50	2	36.8	0.45
LC65	2-1/2	43.2	0.72
LC80	3	45.7	1.14
LC94	4	52.8	1.85

Galvanised Malleable Square Head Plug

Galvanised Malleable Square Head Plug				
AAP CODE	IMPERIAL SIZE	A	C	APPROX KG/PC
LP06	1/8	15.9	7.1	0.01
LP08	1/4	18.7	9.5	0.02
LP10	3/8	20.6	11.0	0.02
LP15	1/2	24.4	14.3	0.04
LP20	3/4	27.7	15.9	0.06
LP25	1	31.8	20.9	0.10
LP32	1-1/4	35.1	23.8	0.15
LP40	1-1/2	37.5	28.6	0.19
LP50	2	40.5	33.3	0.31
LP65	2-1/2	50.8	38.1	0.41
LP80	3	49.7	42.9	0.76
LP94	4	56.4	58.0	1.37
LP96	6	67.4	77.0	5.18

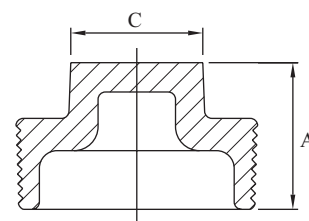
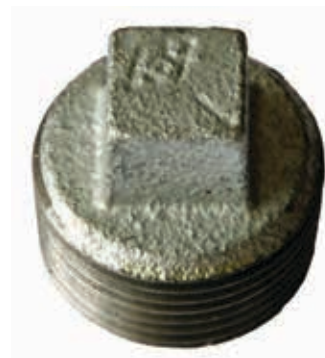

Galvanised Malleable Cross

Galvanised Malleable Cross			
AAP CODE	IMPERIAL SIZE	A	APPROX KG/PC
LCR10	3/8	24.1	0.12
LCR15	1/2	28.5	0.19
LCR20	3/4	33.3	0.29
LCR25	1	38.1	0.45
LCR32	1-1/4	44.5	0.66
LCR40	1-1/2	49.3	0.86
LCR50	2	57.2	1.34
LCR65	2-1/2	68.6	2.49
LCR80	3	80.0	3.59
LCR94	4	94.0	6.43

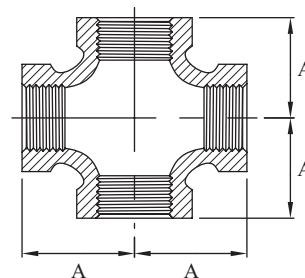

Galvanised Malleable Reducing Socket

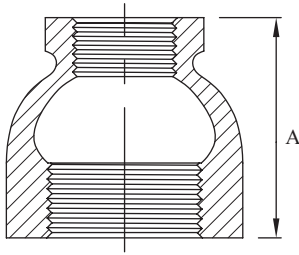

Galvanised Malleable Reducing Socket			
AAP CODE	IMPERIAL SIZE	A	APPROX KG/PC
LS1008	3/8 X 1/4	28.7	0.05
LS1508	1/2 X 1/4	31.8	0.05
LS1510	1/2 X 3/8	31.8	0.07
LS2008	3/4 X 1/4	36.6	0.09
LS2010	3/4 X 3/8	36.6	0.10
LS2015	3/4 X 1/2	36.6	0.11
LS2510	1 X 3/8	42.9	0.16
LS2515	1 X 1/2	42.9	0.16
LS2520	1 X 3/4	42.9	0.18
LS3215	1-1/4 X 1/2	52.3	0.24
LS3220	1-1/4 X 3/4	52.3	0.26
LS3225	1-1/4 X 1	52.3	0.28
LS4015	1-1/2 X 1/2	58.7	0.31
LS4020	1-1/2 X 3/4	58.7	0.32
LS4025	1-1/2 X 1	58.7	0.35
LS4032	1-1/2 X 1-1/4	58.7	0.39
LS5015	2 X 1/2	71.4	0.52
LS5020	2 X 3/4	71.4	0.52
LS5025	2 X 1	71.4	0.55
LS5032	2 X 1-1/4	71.4	0.54
LS5040	2 X 1-1/2	71.4	0.62
LS6525	2-1/2 X 1	82.6	0.89
LS6532	2-1/2 X 1-1/4	82.6	0.93
LS6540	2-1/2 X 1-1/2	82.6	0.94
LS6550	2-1/2 X 2	82.6	1.01
LS8025	3 X 1	93.7	1.39
LS8032	3 X 1-1/4	93.7	1.40
LS8040	3 X 1-1/2	93.7	1.47
LS8050	3 X 2	93.7	1.50
LS8065	3 X 2-1/2	93.7	1.61
LS9450	4 X 2	111.3	2.52
LS9465	4 X 2-1/2	111.3	2.68
LS9480	4 X 3	111.3	2.74

Galvanised Malleable Socket

Galvanised Malleable Socket			
AAP CODE	IMPERIAL SIZE	A	APPROX KG/PC
LS06	1/8	24.4	0.03
LS08	1/4	26.9	0.04
LS10	3/8	29.5	0.1
LS15	1/2	34.0	0.1
LS20	3/4	38.6	0.1
LS25	1	42.4	0.2
LS32	1-1/4	49.0	0.3
LS40	1-1/2	54.6	0.4
LS50	2	64.6	0.6
LS65	2-1/2	73.2	1.1
LS80	3	80.8	1.6
LS94	4	93.7	2.6
LS96	6	105.0	4.5

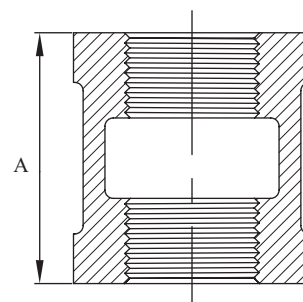

Galvanised Malleable Steel to Brass Female-Female Union

Galvanised Malleable Steel to Brass Female-Female Union			
AAP CODE	IMPERIAL SIZE	A	APPROX KG/PC
LU15BS	1/2	41.5	0.24
LU20BS	3/4	45.0	0.35
LU25BS	1	49.0	0.53
LU32BS	1-1/4	58.0	0.75
LU40BS	1-1/2	63.0	0.95
LU50BS	2	77.0	1.47
LU65BS	2-1/2	79.0	2.41
LU80BS	3	82.0	3.15
LU94BS	4	99.5	5.45

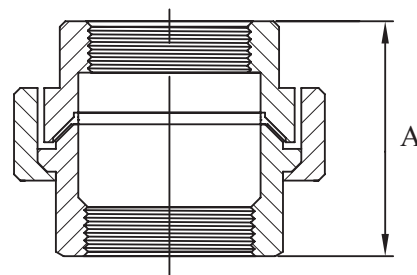

Galvanised Malleable Steel to Steel Female-Female Union



Galvanised Malleable Steel to Steel Female-Female Union			
AAP CODE	IMPERIAL SIZE	A	APPROX KG/PC
LU15FS	1/2	41.5	0.24
LU20FS	3/4	45	0.35
LU25FS	1	49	0.53
LU32FS	1-1/4	58	0.75
LU40FS	1-1/2	63	0.95
LU50FS	2	77	1.47
LU65FS	2-1/2	79	2.41
LU80FS	3	82	3.15

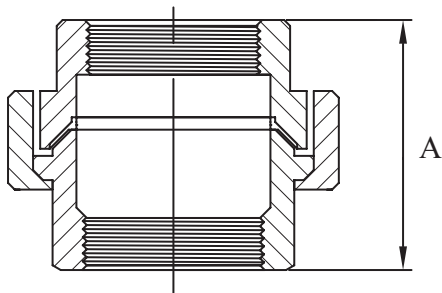

Galvanised Malleable Female-Female Bend 90 Degree



Galvanised Malleable Female-Female Bend 90 Degree			
AAP CODE	IMPERIAL SIZE	A	APPROX KG/PC
LBD10	3/8	44	0.10
LBD15	1/2	52	0.13
LBD20	3/4	65	0.24
LBD25	1	82	0.35
LBD32	1-1/4	100	0.61
LBD40	1-1/2	115	0.77
LBD50	2	140	1.30
LBD65	2-1/2	175	2.40
LBD80	3	205	3.57
LBD94	4	260	6.50

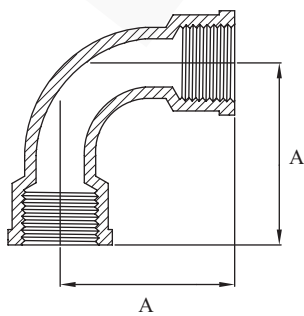

Galvanised Malleable Male-Female Bend 90 Degree

Galvanised Malleable Male-Female Bend 90 Degree			
AAP CODE	IMPERIAL SIZE	A	APPROX KG/PC
LBDMF08	1/4	38	0.06
LBDMF10	3/8	44	0.08
LBDMF15	1/2	52	0.10
LBDMF20	3/4	65	0.19
LBDMF25	1	82	0.30
LBDMF32	1-1/4	100	0.53
LBDMF40	1-1/2	115	0.66
LBDMF50	2	140	1.20
LBDMF65	2-1/2	175	2.25
LBDMF80	3	205	3.00
LBDMF94	4	260	6.75

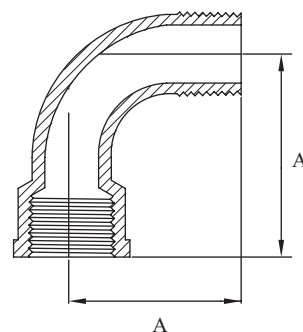

Galvanised Malleable Flange BS10 Undrilled Table "D"

Galvanised Malleable Flange BS10 Undrilled Table "D"					
AAP CODE	IMPERIAL SIZE	A	B	C	APPROX KG/PC
LF15	1/2	95.0	12.7	7.2	0.27
LF20	3/4	102.0	15.9	7.9	0.30
LF25	1	114.0	17.5	8.7	0.50
LF32	1-1/4	120.0	19.1	8.7	0.65
LF40	1-1/2	133.0	22.2	9.5	0.76
LF50	2	152.0	25.4	10.3	1.09
LF65	2-1/2	164.5	30.0	10.3	1.36
LF80	3	184.0	33.8	10.3	1.70
LF94	4	216.0	39.0	11.2	2.55
LF96	6	280.0	41.7	13.8	4.50

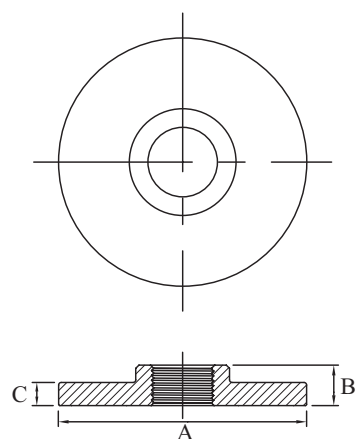

Galvanised Malleable Flange BS10 Drilled Table "D"

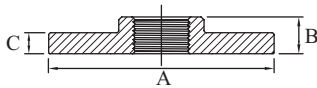
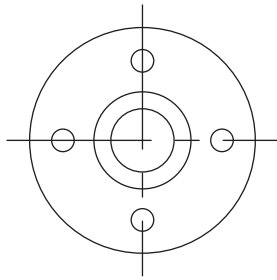

Galvanised Malleable Flange BS10 Drilled Table "D"					
AAP CODE	IMPERIAL SIZE	A	B	C	APPROX KG/PC
LFD15	1/2	88.9	12.7	7.2	0.29
LFD20	3/4	88.9	15.9	7.9	0.33
LFD25	1	101.6	17.5	8.7	0.46
LFD32	1-1/4	101.6	19.1	8.7	0.45
LFD40	1-1/2	114.3	22.2	9.5	0.62
LFD50	2	139.7	25.4	10.3	0.96
LFD65	2-1/2	165.0	30.0	10.3	1.28
LFD80	3	185.0	33.8	10.3	1.75
LFD94	4	215.0	39.0	11.2	2.63
LFD96	6	280.0	41.7	13.8	4.72

Galvanised Malleable Flange Oval

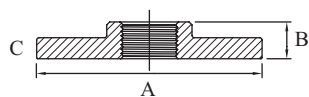
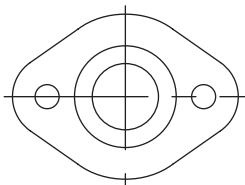

Galvanised Malleable Flange Oval					
AAP CODE	IMPERIAL SIZE	A	B	C	APPROX KG/PC
LFO15	1/2	80	17	55.0	0.18
LFO20	3/4	90	19	66.0	0.27
LFO25	1	100	21.8	75.0	0.38
LFO32	1-1/4	120	22	90.0	0.59
LFO40	1-1/2	132	24	100.0	0.72
LFO50	2	140	24	110.0	0.77

Galvanised Malleable Backnut

Galvanised Malleable Backnut				
AAP CODE	IMPERIAL SIZE	A	B	APPROX KG/PC
LBN15	1/2	8.1	30.0	0.03
LBN20	3/4	8.8	36.3	0.04
LBN25	1	9.9	44.5	0.06
LBN32	1-1/4	10.9	53.3	0.09
LBN40	1-1/2	12.1	59.7	0.11
LBN50	2	13.7	73.2	0.18
LBN65	2-1/2	16.0	90.1	0.29
LBN80	3	20.8	107.0	0.54
LBN94	4	23.7	136.0	1.06

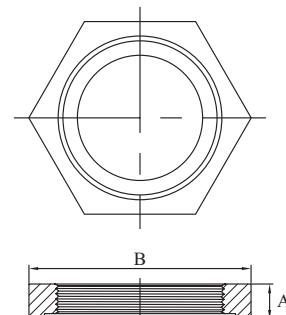

Galvanised Medium Pipe Pieces PE (BS 1387-85) Both Ends BSP Taper

Galvanised Medium Pipe Pieces PE (BS 1387-85) Both Ends BSP Taper			
AAP CODE	IMPERIAL SIZE	A	APPROX KG/PC
SPN0640G	1/8	40	0.05
SPN0660G	1/8	60	0.05
SPN0680G	1/8	80	0.07
SPN0694G	1/8	100	0.08
SPN0840G	1/4	40	0.03
SPN0850G	1/4	50	0.04
SPN0860G	1/4	60	0.05
SPN0875G	1/4	75	0.06
SPN0880G	1/4	80	0.06
SPN0894G	1/4	100	0.08
SPN08140G	1/4	140	0.11
SPN0896G	1/4	150	0.12
SPN1040G	3/8	40	0.04
SPN1050G	3/8	50	0.05
SPN1060G	3/8	60	0.06
SPN1075G	3/8	75	0.08
SPN1094G	3/8	100	0.10
SPN10140G	3/8	140	0.14
SPN1096G	3/8	150	0.15
SPN1540G	1/2	40	0.04
SPN1560G	1/2	60	0.06
SPN1580G	1/2	80	0.08
SPN1594G	1/2	100	0.10
SPN15120G	1/2	120	0.12
SPN15140G	1/2	140	0.14
SPN1596G	1/2	150	0.15
SPN1598G	1/2	200	0.20
SPN15X25G	1/2	250	0.25

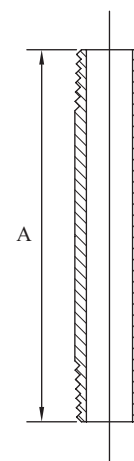

AAP can also offer lengths according to customer's requirements - minimum order qty's may apply

Galvanised Medium Pipe Pieces PE (BS 1387-85) Both Ends BSP Taper

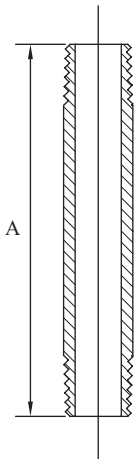

Galvanised Medium Pipe Pieces PE (BS 1387-85) Both Ends BSP Taper			
AAP CODE	IMPERIAL SIZE	A	APPROX KG/PC
SPN15X30G	1/2	300	0.30
SPN15X35G	1/2	350	0.35
SPN15X40G	1/2	400	0.40
SPN15X45G	1/2	450	0.45
SPN15X50G	1/2	500	0.50
SPN15X60G	1/2	600	0.60
SPN15X75G	1/2	750	0.75
SPN15X90G	1/2	900	0.90
SPN15X100G	1/2	1000	1.00
SPN15X122G	1/2	1220	1.22
SPN15X152G	1/2	1524	1.52
SPN15X183G	1/2	1829	1.83
SPN2060G	3/4	60	0.08
SPN2080G	3/4	80	0.10
SPN2094G	3/4	100	0.13
SPN20120G	3/4	120	0.16
SPN20140G	3/4	140	0.18
SPN2096G	3/4	150	0.20
SPN2098G	3/4	200	0.26
SPN20X25G	3/4	250	0.33
SPN20X30G	3/4	300	0.39
SPN20X35G	3/4	350	0.46
SPN20X40G	3/4	400	0.52
SPN20X45G	3/4	450	0.59
SPN20X50G	3/4	500	0.65
SPN20X55G	3/4	550	0.72
SPN20X60G	3/4	600	0.78
SPN20X75G	3/4	750	0.98
SPN20X90G	3/4	900	1.17
SPN20X100G	3/4	1000	1.30
SPN20X122G	3/4	1220	1.59
SPN20X152G	3/4	1524	1.98
SPN20X183G	3/4	1829	2.38
SPN2580G	1	80	0.17
SPN2594G	1	100	0.21
SPN25120G	1	120	0.25
SPN25140G	1	140	0.29
SPN2596G	1	150	0.32
SPN2598G	1	200	0.42
SPN25X25G	1	250	0.53
SPN25X30G	1	300	0.63
SPN25X35G	1	350	0.74
SPN25X40G	1	400	0.84
SPN25X45G	1	450	0.95
SPN25X50G	1	500	1.05
SPN25X55G	1	550	1.16

AAP can also offer lengths according to customer's requirements - minimum order qty's may apply

Galvanised Medium Pipe Pieces PE (BS 1387-85) Both Ends BSP Taper

Galvanised Medium Pipe Pieces PE (BS 1387-85) Both Ends BSP Taper			
AAP CODE	IMPERIAL SIZE	A	APPROX KG/PC
SPN25X60G	1	600	1.26
SPN25X75G	1	750	1.58
SPN25X90G	1	900	1.89
SPN25X100G	1	1000	2.10
SPN25X122G	1	1220	2.56
SPN25X152G	1	1524	3.20
SPN25X183G	1	1829	3.84
SPN3260G	1 1/4	60	0.14
SPN3280G	1 1/4	80	0.19
SPN3294G	1 1/4	100	0.24
SPN32140G	1 1/4	140	0.34
SPN3296G	1 1/4	150	0.36
SPN3298G	1 1/4	200	0.48
SPN32X25G	1 1/4	250	0.60
SPN32X30G	1 1/4	300	0.72
SPN32X35G	1 1/4	350	0.84
SPN32X40G	1 1/4	400	0.96
SPN32X45G	1 1/4	450	1.08
SPN32X50G	1 1/4	500	1.20
SPN32X55G	1 1/4	550	1.32
SPN32X60G	1 1/4	600	1.44
SPN32X75G	1 1/4	750	1.80
SPN32X90G	1 1/4	900	2.16
SPN32X122G	1 1/4	1220	2.93
SPN4060G	1 1/2	60	0.19
SPN4080G	1 1/2	80	0.25
SPN4094G	1 1/2	100	0.31
SPN40120G	1 1/2	120	0.37
SPN40140G	1 1/2	140	0.43
SPN4096G	1 1/2	150	0.47
SPN4098G	1 1/2	200	0.62
SPN40X25G	1 1/2	250	0.78
SPN40X30G	1 1/2	300	0.93
SPN40X35G	1 1/2	350	1.09
SPN40X40G	1 1/2	400	1.24
SPN40X45G	1 1/2	450	1.40
SPN40X50G	1 1/2	500	1.55
SPN40X60G	1 1/2	600	1.86
SPN40X75G	1 1/2	750	2.33
SPN40X90G	1 1/2	900	2.79
SPN40X100G	1 1/2	1000	3.10
SPN40X122G	1 1/2	1220	3.78
SPN5094G	2	100	0.41
SPN50120G	2	120	0.49
SPN50140G	2	140	0.57
SPN5096G	2	150	0.62

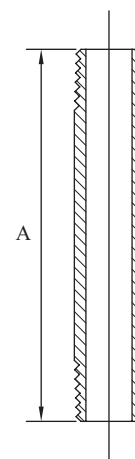

AAP can also offer lengths according to customer's requirements - minimum order qty's may apply

Galvanised Medium Pipe Pieces PE (BS 1387-85) Both Ends BSP Taper

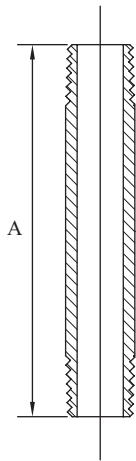

Galvanised Medium Pipe Pieces PE (BS 1387-85) Both Ends BSP Taper			
AAP CODE	IMPERIAL SIZE	A	APPROX KG/PC
SPN5098G	2	200	0.82
SPN50X25G	2	250	1.03
SPN50X30G	2	300	1.23
SPN50X35G	2	350	1.44
SPN50X40G	2	400	1.64
SPN50X45G	2	450	1.85
SPN50X50G	2	500	2.05
SPN50X60G	2	600	2.46
SPN50X75G	2	750	3.08
SPN50X90G	2	900	3.69
SPN50X100G	2	1000	4.10
SPN50X122G	2	1220	5.00
SPN6580G	2 1/2	80	0.43
SPN6594G	2 1/2	100	0.54
SPN65140G	2 1/2	140	0.76
SPN6596G	2 1/2	150	0.81
SPN6598G	2 1/2	200	1.08
SPN65X25G	2 1/2	250	1.35
SPN65X30G	2 1/2	300	1.62
SPN65X45G	2 1/2	450	2.43
SPN65X60G	2 1/2	600	3.24
SPN8080G	3	80	0.39
SPN80120G	3	120	0.59
SPN80140G	3	140	0.69
SPN8096G	3	150	0.74
SPN8098G	3	200	0.98
SPN80X25G	3	250	1.23
SPN80X30G	3	300	1.47
SPN80X45G	3	450	2.21
SPN80X60G	3	600	2.94
SPN80X75G	3	750	3.68
SPN80X90G	3	900	4.41
SPN80X100G	3	1000	4.90
SPN9494G	4	100	1.03
SPN94120G	4	120	1.23
SPN94140G	4	140	1.44
SPN9496G	4	150	1.54
SPN9498G	4	200	2.05
SPN94X25G	4	250	2.57
SPN94X30G	4	300	3.08
SPN94X45G	4	450	4.62
SPN94X60G	4	600	6.16
SPN94X75G	4	750	7.70
SPN94X90G	4	900	9.24
SPN94X100G	4	1000	10.27
SPN95X30G	5	300	3.40
SPN95X60G	5	600	6.80

AAP can also offer lengths according to customer's requirements - minimum order qty's may apply

