

elson DN25-DN25 90 DEG Elbow Capillary LE HP SR

Product Code : 37084

Brand Name: elson

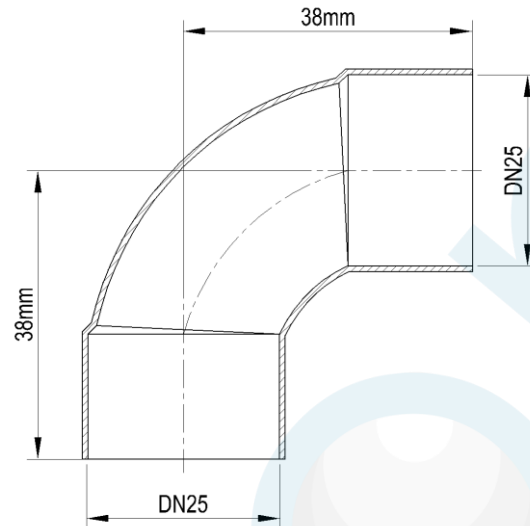

Product Specification

- Watermark Licence Number: WMK 26127
- In compliance with AS 3688
- Material: Copper, Complies with AS 1432
- Suitable for Potable Water – complies with AS/NZS 4020
- Maximum Working Pressure at 95°C : 1400Kpa
- Maximum Working Pressure at 20°C : 2000Kpa
- Copper tube compliant with AS 1432
- Silver Solder for “Brazing” compliant with AS 1167.1

Elson Australasia Pty Ltd

Tel: 02 9625 7899 Fax: 02 9625 7855

Website: www.elson.net.au E-mail: sales@elson.net.au

Version 2.0

Aug. 2020