



Section 7

Stainless Steel 316 Threaded Fittings

Edition 3

Specifications

About Stainless Steel - Stainless steel can be defined as a steel alloy that has a minimum chromium level of 11% of its mass. Stainless steel fittings are used when the properties of steel and resistance to corrosion are required.

Applications - Stainless Steel Fittings are most suitable for marine, pumping, commercial, domestic chemical and irrigation applications.

AAP '150lb' stainless steel fittings are made from grade 316 stainless steel. 150lb refers to the maximum working pressure/temperature of 150psi saturated steam.

Applicable Standards

- AS 1722.2 - Pipe Threads of Whitworth Form (Fastening thread)
- ASTM A351 - Standard Specification of Castings, Austenitic for pressure-containing parts
- ASTM A182 - Standard Specification for forged or rolled alloy and stainless steel pipe flanges, forged fittings, valves and parts for high temperature parts
- ISO 4144 - Pipework - Stainless Steel fittings Threaded in Accordance with ISO7 - 1

British Standard Threads							
All measurements in mm							
NOMINAL BORE OF PIPE		APPROX. OUTSIDE DIAMETER	NUMBER OF THREADS PER INCH	PITCH	DEPTH OF THREADS	DIAMETER AT GAUGE PLANE	LENGTH OF USEFUL THREAD
IMPERIAL	METRIC	A		P	h	B	E
1/8	6	10.16	28	0.907	0.581	9.72	6.5
1/4	8	13.66	19	1.337	0.856	13.15	9.7
3/8	10	17.17	19	1.337	0.856	16.66	10.1
1/2	15	21.51	14	1.814	1.162	20.95	13.2
3/4	20	27.00	14	1.814	1.162	26.44	14.5
1	25	33.93	11	2.309	1.479	33.24	16.8
1 1/4	32	42.59	11	2.309	1.479	41.91	19.1
1 1/2	40	48.48	11	2.309	1.479	47.80	19.1
2	50	60.47	11	2.309	1.479	59.61	23.4
2 1/2	65	76.09	11	2.309	1.479	75.18	26.7
3	80	88.87	11	2.309	1.479	87.88	29.8
4	100	114.14	11	2.309	1.479	113.03	35.8
5	125	139.65	11	2.309	1.479	138.43	40.1
6	150	165.12	11	2.309	1.479	163.83	40.1

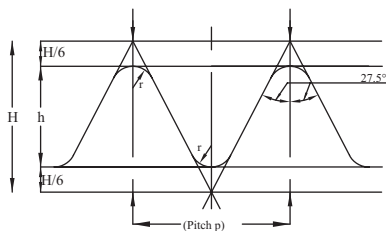

Fig. 1. (Parallel)
 $H = 0.960491 \times p$
 $h = 0.640327 \times p$
 $r = 0.137329 \times p$

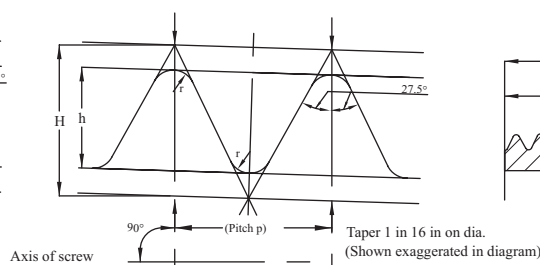

Fig. 2. (Taper)
 $H = 0.960237 \times p$
 $h = 0.640327 \times p$
 $r = 0.137278 \times p$

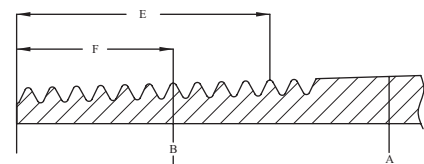

Fig. 3. (Taper)

Mechanical Properties		
TENSILE STRENGTH MIN.	YIELD STRENGTH MIN.	ELONGATION MIN.
70000 psi	25000 psi	35%

316/316L Chemical Composition %							
C MAX	Cr	Mn MAX	Mo	Ni	P MAX	S MAX	Si MAX
0.035	16.0-20.0	2	2.0-3.0	10-15.0	0.04	0.03	0.75

Stainless Steel Bushes

316 '150lb' Stainless Steel Bushes				
AAP CODE	IMPERIAL SIZE	A	C	APPROX KG/PC
SSB0806	1/4 x 1/8	17	15	0.01
SSB1008	3/8 x 1/4	20.5	22	0.03
SSB1508	1/2 x 1/4	18	23	0.02
SSB1510	1/2 x 3/8	21	23	0.03
SSB2008	3/4 x 1/4	21	28	0.03
SSB2010	3/4 x 3/8	21	28	0.03
SSB2015	3/4 x 1/2	26	28	0.06
SSB2510	1 x 3/8	26	35	0.09
SSB2515	1 x 1/2	26	35	0.09
SSB2520	1 x 3/4	26	35	0.07
SSB3215	1 1/4 x 1/2	29	44	0.17
SSB3220	1 1/4 x 3/4	29	44	0.14
SSB3225	1 1/4 x 1	29	44	0.11
SSB4020	1 1/2 x 3/4	31	50	0.20
SSB4025	1 1/2 x 1	31	50	0.18
SSB4032	1 1/2 x 1 1/4	31	50	0.12
SSB5020	2 x 3/4	37	61	0.41
SSB5025	2 x 1	37	61	0.35
SSB5032	2 x 1 1/4	35	61	0.30
SSB5040	2 x 1 1/2	35	61	0.24
SSB6540	2 1/2 x 1 1/2	38	80	0.60
SSB6550	2 1/2 x 2	39	80	0.49
SSB8040	3 x 1 1/2	42	92	0.97
SSB8050	3 x 2	42	92	0.85
SSB8065	3 x 2 1/2	42	92	0.71
SSB10050	4 x 2	49	116	1.62
SSB10065	4 x 2 1/2	49	116	1.35
SSB10080	4 x 3	49	116	1.28

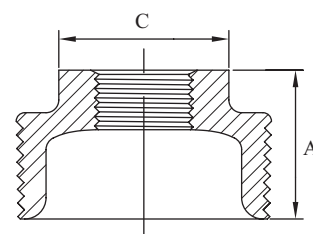
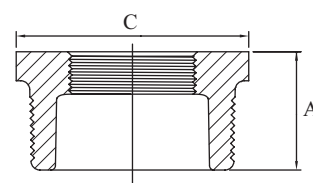

Stainless Steel Barrel Nipples

316 '150lb' Stainless Steel Barrel Nipples			
AAP CODE	SIZE IMPERIAL	A	APPROX KG/PC
SSBN08	1/4	39.5	0.02
SSBN10	3/8	39.5	0.03
SSBN15	1/2	60	0.06
SSBN20	3/4	60	0.09
SSBN25	1	60	0.12
SSBN32	1 1/4	79.5	0.23
SSBN40	1 1/2	79.5	0.26
SSBN50	2	99	0.45
SSBN65	2 1/2	100	0.70
SSBN80	3	120	1.19
SSBN100	4	151	1.85

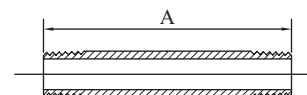

Stainless Steel Caps

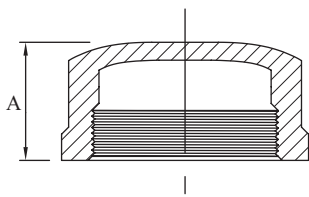

316 '150lb' Stainless Steel Caps			
AAP CODE	IMPERIAL SIZE	A	APPROX KG/PC
SSC06	1/8	14	0.01
SSC08	1/4	15.6	0.01
SSC10	3/8	17.5	0.03
SSC15	1/2	20	0.05
SSC20	3/4	21.7	0.06
SSC25	1	26	0.09
SSC32	1 1/4	28.5	0.13
SSC40	1 1/2	32.6	0.19
SSC50	2	34	0.28
SSC65	2 1/2	38.7	0.47
SSC80	3	42.5	0.69
SSC100	4	48.4	1.30

Stainless Steel Couplings

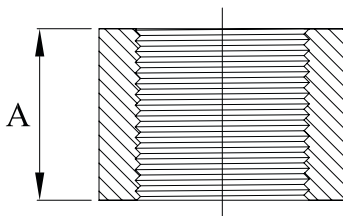

316 '150lb' Stainless Steel Couplings			
AAP CODE	IMPERIAL SIZE	A	APPROX KG/PC
SSCP06	1/8	16	0.01
SSCP08	1/4	24	0.02
SSCP10	3/8	25	0.02
SSCP15	1/2	33	0.06
SSCP20	3/4	36	0.07
SSCP25	1	43	0.11
SSCP32	1 1/4	47	0.17
SSCP40	1 1/2	47	0.14
SSCP50	2	52	0.29
SSCP65	2 1/2	62	0.41
SSCP80	3	68	0.65
SSCP100	4	77	1.26

Stainless Steel Half Couplings

316 '150lb' Stainless Steel Half Couplings			
AAP CODE	IMPERIAL SIZE	A	APPROX KG/PC
SSCH15	1/2	15	0.03
SSCH20	3/4	17	0.04
SSCH25	1	20	0.05
SSCH32	1 1/4	22	0.09
SSCH40	1 1/2	22	0.09
SSCH50	2	24	0.11

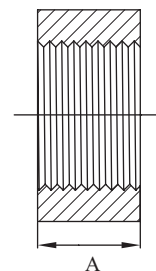

Stainless Steel Reducing Sockets

316 '150lb' Stainless Steel Reducing Sockets			
AAP CODE	IMPERIAL SIZE	A	APPROX KG/PC
SSS0806	1/4 x 1/8	26	0.01
SSS1008	3/8 x 1/4	30	0.03
SSS1508	1/2 x 1/4	33	0.06
SSS1510	1/2 x 3/8	33	0.04
SSS2010	3/4 x 3/8	36	0.07
SSS2015	3/4 x 1/2	36	0.07
SSS2510	1 x 3/8	42	0.12
SSS2515	1 x 1/2	42	0.09
SSS2520	1 x 3/4	43	0.11
SSS3215	1 1/4 x 1/2	45	0.25
SSS3220	1 1/4 x 3/4	45	0.16
SSS3225	1 1/4 x 1	45	0.18
SSS4020	1 1/2 x 3/4	49	0.22
SSS4025	1 1/2 x 1	49	0.19
SSS4032	1 1/2 x 1 1/4	49	0.24
SSS5025	2 x 1	51	0.28
SSS5032	2 x 1 1/4	51	0.28
SSS5040	2 x 1 1/2	51	0.29
SSS6540	2 1/2 x 1 1/2	65	0.46
SSS6550	2 1/2 x 2	65	0.50
SSS8040	3 x 1 1/2	72	0.73
SSS8050	3 x 2	72	0.80
SSS8065	3 x 2 1/2	72	0.73
SSS10050	4 x 2	68	1.70
SSS10065	4 x 2 1/2	68	1.50
SSS10080	4 x 3	68	1.30

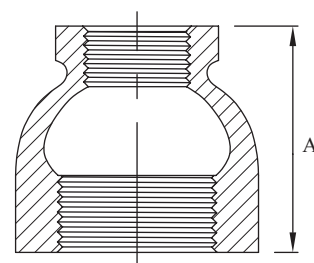

Stainless Steel 90 deg F/F Elbows

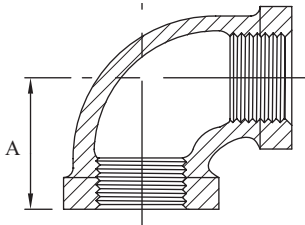

316 '150lb' Stainless Steel 90 Degree F/F Elbows			
AAP CODE	IMPERIAL SIZE	A	APPROX KG/PC
SSE06	1/8	17	0.02
SSE08	1/4	19	0.02
SSE10	3/8	23	0.04
SSE15	1/2	27	0.09
SSE20	3/4	32	0.11
SSE25	1	38	0.15
SSE32	1 1/4	45	0.24
SSE40	1 1/2	48	0.33
SSE50	2	57	0.61
SSE65	2 1/2	69	0.83
SSE80	3	78	1.38
SSE100	4	96	3.40

Stainless Steel 90 Deg M/F Elbows

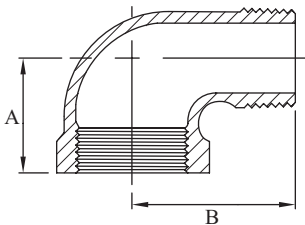

316 '150lb' Stainless Steel 90 Degree M/F Elbows				
AAP CODE	IMPERIAL SIZE	A	B	APPROX KG/PC
SSEMF06	1/8	17	26	0.02
SSEMF08	1/4	19	31	0.03
SSEMF10	3/8	23	39	0.04
SSEMF15	1/2	27	41	0.07
SSEMF20	3/4	32	47	0.11
SSEMF25	1	38	53	0.18
SSEMF32	1 1/4	45	63	0.30
SSEMF40	1 1/2	48	69	0.34
SSEMF50	2	57	80	0.57
SSEMF65	2 1/2	69	83	0.85
SSEMF80	3	78	94	1.32
SSEMF100	4	96	115	2.65

Stainless Steel 45 Deg M/F Elbows

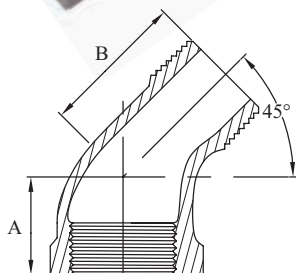

316 '150lb' Stainless Steel 45 Degree M/F Elbows				
AAP CODE	IMPERIAL SIZE	A	B	APPROX KG/PC
SSEMFF15	1/2	21	40	0.1
SSEMFF20	3/4	25	45	0.1
SSEMFF25	1	29	46	0.2
SSEMFF32	1 1/4	33	51	0.3
SSEMFF40	1 1/2	37	55	0.3
SSEMFF50	2	42	60	0.5

Stainless Steel 45 Deg F/F Elbows

316 '150lb' Stainless Steel 45 Degree F/F Elbows			
AAP CODE	IMPERIAL SIZE	A	APPROX KG/PC
SSEF08	1/4	17	0.03
SSEF10	3/8	19	0.04
SSEF15	1/2	21	0.07
SSEF20	3/4	25	0.09
SSEF25	1	29	0.16
SSEF32	1 1/4	33	0.21
SSEF40	1 1/2	37	0.30
SSEF50	2	42	0.44
SSEF65	2 1/2	49	0.94
SSEF80	3	54	1.54
SSEF100	4	64	1.92

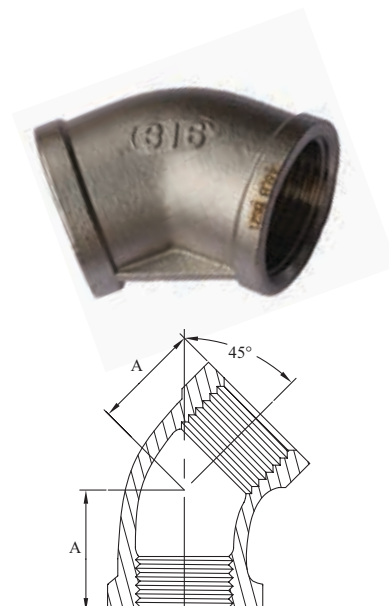

Stainless Steel 'Sched 40' Pipe Pieces (Welded)

316 'Sched 40' Stainless Steel Pipe Pieces (Welded) Both Ends BSP Taper			
AAP CODE	IMPERIAL SIZE	A	APPROX KG/PC
SSPN1594	1/2	100	0.11
SSPN1596	1/2	150	0.17
SSPN1598	1/2	200	0.22
SSPN15X30	1/2	300	0.33
SSPN15X60	1/2	600	0.66
SSPN2094	3/4	100	0.14
SSPN2096	3/4	150	0.22
SSPN2098	3/4	200	0.29
SSPN20X30	3/4	300	0.43
SSPN20X60	3/4	600	0.86
SSPN2594	1	100	0.23
SSPN2596	1	150	0.35
SSPN2598	1	200	0.46
SSPN25X30	1	300	0.69
SSPN25X60	1	600	1.39
SSPN3294	1 1/4	100	0.26
SSPN3296	1 1/4	150	0.40
SSPN3298	1 1/4	200	0.53
SSPN32X30	1 1/4	300	0.79
SSPN32X60	1 1/4	600	1.58
SSPN4094	1 1/2	100	0.34
SSPN4096	1 1/2	150	0.52
SSPN4098	1 1/2	200	0.68
SSPN40X30	1 1/2	300	1.02
SSPN40X60	1 1/2	600	2.05
SSPN5094	2	100	0.45
SSPN5096	2	150	0.68
SSPN5098	2	200	0.90
SSPN50X30	2	300	1.35
SSPN50X60	2	600	2.71

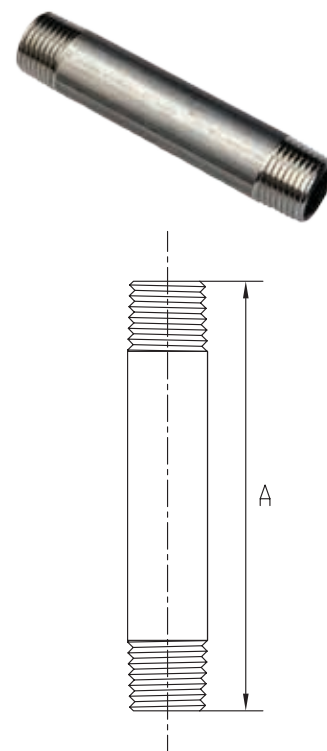

Stainless Steel Hose Nipple

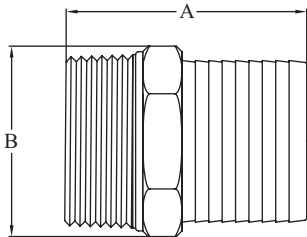

316 '150lb' Stainless Steel Hose Nipple				
AAP CODE	IMPERIAL SIZE	A	B	APPROX KG/PC
SSHN08	1/4	43	16	0.02
SSHN10	3/8	48	19	0.04
SSHN1015	3/8 x 1/2	60	19	0.04
SSHN15	1/2	58	22	0.05
SSHN1510	1/2 x 3/8	60	24	0.05
SSHN1520	1/2 x 3/4	60	25	0.07
SSHN20	3/4	64.6	27	0.09
SSHN2015	3/4 x 1/2	64	28	0.09
SSHN2025	3/4 x 1	79	30	0.14
SSHN25	1	72.5	35	0.14
SSHN2520	1 x 3/4	67	36	0.14
SSHN32	1 1/4	82	47	0.21
SSHN40	1 1/2	88	52	0.27
SSHN50	2	97.5	61	0.42
SSHN65	2 1/2	106	79	0.83
SSHN80	3	111	92	0.87
SSHN100	4	151	117	2.32

Stainless Steel Hexagon Nipple

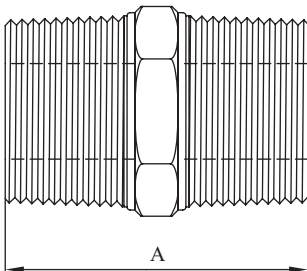

316 '150lb' Stainless Steel Hexagon Nipple			
AAP CODE	IMPERIAL SIZE	A	APPROX KG/PC
SSN06	1/8	28	0.01
SSN08	1/4	32	0.02
SSN10	3/8	37	0.03
SSN15	1/2	40	0.05
SSN20	3/4	44	0.08
SSN25	1	46	0.14
SSN32	1 1/4	53	0.16
SSN40	1 1/2	54	0.20
SSN50	2	63	0.30
SSN65	2 1/2	72	0.54
SSN80	3	80	0.74
SSN100	4	85	1.01

Stainless Steel Reducing Hexagon Nipple

316 '150lb' Stainless Steel Reducing Hex Nipple			
AAP CODE	IMPERIAL SIZE	A	APPROX KG/PC
SSN0806	1/4 x 1/8	30	0.02
SSN1008	3/8 x 1/4	35	0.02
SSN1508	1/2 x 1/4	40	0.03
SSN1510	1/2 x 3/8	36	0.03
SSN2010	3/4 x 3/8	41	0.1
SSN2015	3/4 x 1/2	42	0.1
SSN2510	1 x 3/8	45	0.1
SSN2515	1 x 1/2	48	0.1
SSN2520	1 x 3/4	49	0.1
SSN3215	1 1/4 x 1/2	50	0.2
SSN3220	1 1/4 x 3/4	51	0.2
SSN3225	1 1/4 x 1	51	0.2
SSN4020	1 1/2 x 3/4	50	0.2
SSN4025	1 1/2 x 1	50	0.2
SSN4032	1 1/2 x 1 1/4	53.8	0.2
SSN5020	2 x 3/4	57	0.4
SSN5025	2 x 1	57.5	0.3
SSN5032	2 x 1 1/4	60	0.3
SSN5040	2 x 1 1/2	62	0.3
SSN6540	2 1/2 x 1 1/2	65.5	0.5
SSN6550	2 1/2 x 2	71	0.6
SSN8040	3 x 1 1/2	62.5	1.0
SSN8050	3 x 2	75	0.9
SSN8065	3 x 2 1/2	77	1.1
SSN10050	4 x 2	80	2.0
SSN10065	4 x 2 1/2	83	1.8
SSN10080	4 x 3	87	1.6

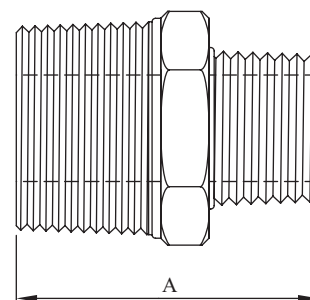

Stainless Steel Weld Nipples

316 '150lb' Stainless Steel Weld Nipples			
AAP CODE	IMPERIAL SIZE	A	APPROX KG/PC
SSWN08	1/4	30	0.02
SSWN10	3/8	30	0.02
SSWN15	1/2	33	0.03
SSWN20	3/4	39	0.06
SSWN25	1	40	0.08
SSWN32	1 1/4	50	0.15
SSWN40	1 1/2	50	0.19
SSWN50	2	50	0.21
SSWN65	2 1/2	60	0.41
SSWN80	3	70	0.59
SSWN100	4	80	0.95

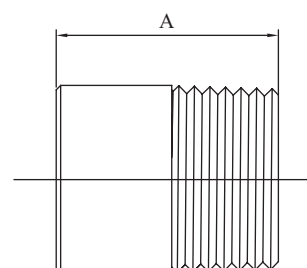

Stainless Steel Plug

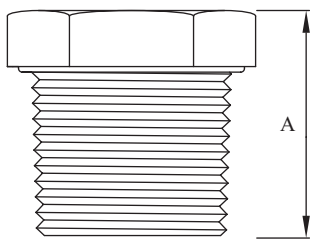

316 '150lb' Stainless Steel Plug			
AAP CODE	IMPERIAL SIZE	A	APPROX KG/PC
SSP06	1/8	17	0.01
SSP08	1/4	18	0.01
SSP10	3/8	20	0.02
SSP15	1/2	21.5	0.03
SSP20	3/4	24.5	0.07
SSP25	1	27	0.09
SSP32	1 1/4	29	0.13
SSP40	1 1/2	31	0.16
SSP50	2	35	0.25
SSP65	2 1/2	40	0.53
SSP80	3	44	0.73
SSP100	4	45	1.2

Stainless Steel Equal Tees

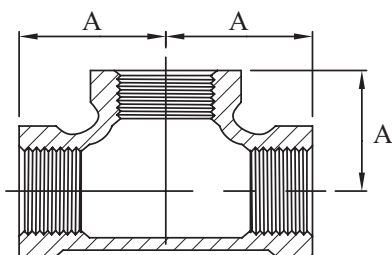

316 '150lb' Stainless Steel Equal Tees			
AAP CODE	IMPERIAL SIZE	A	APPROX KG/PC
SST06	1/8	17	0.03
SST08	1/4	19	0.04
SST10	3/8	23	0.06
SST15	1/2	27	0.09
SST20	3/4	32	0.13
SST25	1	38	0.24
SST32	1 1/4	45	0.36
SST40	1 1/2	48	0.44
SST50	2	57	0.64
SST65	2 1/2	69	1.25
SST80	3	78	1.59
SST100	4	96	3.98

Stainless Steel F/F Unions

316 '150lb' Stainless Steel F/F Unions			
AAP CODE	IMPERIAL SIZE	A	APPROX KG/PC
SSU06	1/8	28.3	0.05
SSU08	1/4	29.6	0.08
SSU10	3/8	35	0.1
SSU15	1/2	35	0.12
SSU20	3/4	40	0.19
SSU25	1	45	0.27
SSU32	1 1/4	51	0.44
SSU40	1 1/2	59	0.71
SSU50	2	65	0.88
SSU65	2 1/2	73	1.25
SSU80	3	76.5	1.87
SSU100	4	113	3.27

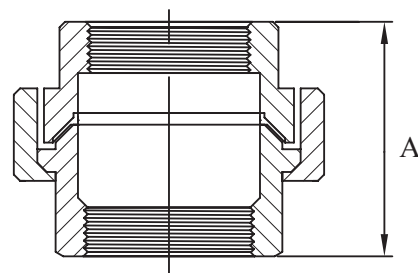

Stainless Steel M/F Unions

316 '150lb' Stainless Steel M/F Unions			
AAP CODE	IMPERIAL SIZE	A	APPROX KG/PC
SSU08MF	1/4	44	0.09
SSU10MF	3/8	47	0.13
SSU15MF	1/2	55.3	0.17
SSU20MF	3/4	59	0.31
SSU25MF	1	64	0.39
SSU32MF	1 1/4	69	0.59
SSU40MF	1 1/2	79	0.64
SSU50MF	2	93	1.03

