



Section 10

Camlocks

(Aluminium, Stainless Steel 316, Nyglass, Polypropylene)

Edition 3

Specifications

Camlocks are also known as Cam and Groove Fittings

The AAP Industries range of Camlock are manufactured to interchange with all product produced to Mil Spec A-A 59326. Size 1/2" (15mm) and 8" (200mm) fittings are not covered by Mil Spec A-A 59326, these sizes are to manufactures specification only.

Used where quick, convenient connection and disconnection of piping and hose is required.

Industries – Irrigation, Pumping, Hose Distributors, Bulk Tankers, Water Carriers, General Industry.

Medium – Water, Oil, Powders, some Hydrocarbons and Chemicals (check compatibility charts).

Threads - The threads are cut according to ISO 228

Maximum Temperature – NBR (Buna) Gasket 100 degree Celcius.

Spare Parts – AAP have available a range of spare parts to suit the camlocks, such as Brass Handles (code CBH...), Handle Pins (code CP...), and NBR Gaskets (code CGN...).

Camlocks		
MATERIAL	TYPICAL APPLICATION	DESCRIPTION
ALUMINIUM DIECAST (Conforming to ASTM B 26B 26M)	GENERAL USE / AG / INDUSTRIAL	MANUFACTURED USING THE DIE-CASTING METHOD. THIS THE MOST COMMON / ECONOMICAL OF THE ALUMINIUM RANGE USED FOR GENERAL AIR / WATER APPLICATIONS.
POLY PROPYLENE (BLACK) PP (30% glass filled)	AG SPRAYING EQUIPMENT / CHEMICAL INDUSTRY	USED EXTENSIVELY THROUGHOUT THE CHEMICAL AND AGRICULTURAL SECTOR.
NY-GLASS (YELLOW) (30% glass filled)	AG SPRAYING EQUIPMENT / CHEMICAL INDUSTRY	GLASS FILLED NYLON. ALTERNATIVE TO POLY PROPYLENE.
STAINLESS STEEL 316	FOOD INDUSTRY / OFFSHORE / CHEMICAL INDUSTRY	SAND CAST STAINLESS STEEL. FULLY WELDABLE.

WORKING PRESSURE OF CAMLOCKS		
SIZE RANGE (mm)	ALUMINIUM, STAINLESS, BRONZE, BRASS	POLY PROPYLENE, NYGLASS
15	1034kPa	862kPa
20-50	1724kPa	862kPa
65	1034kPa	690kPa
75	862kPa	517kPa
100	690kPa	517kPa
125	517kPa	N/A
150	517kPa	N/A

PRODUCT SUMMARY	
TYPE A	Male Camlock x Female BSP
TYPE B	Female Camlock x Male BSP
TYPE C	Female Camlock x Hosebarb
TYPE D	Female Camlock x Female BSP
TYPE E	Male Camlock x Hosebarb
TYPE F	Male Camlock x Male BSP
TYPE DC	Dust Cap
TYPE DP	Dust Plug

Type A Camlock - Male Camlock X Female BSP

Type A Camlock - Male Camlock X Female BSP							
AAP CODE		IMPERIAL SIZE	A	B	C	ALLUMINIUM KG/PC	STAINLESS STEEL KG/PC
ALUMINIUM	STAINLESS STEEL						
CAL15A	CSS15A	1/2	21	41	32	0.02	0.04
CAL20A	CSS20A	3/4	21	41	32	0.04	0.09
CAL25A	CSS25A	1	24	52	40	0.06	0.11
CAL32A	CSS32A	1 1/4	28.5	54	48	0.09	0.2
CAL40A	CSS40A	1 1/2	36	57	56	0.12	0.3
CAL50A	CSS50A	2	45	62	67	0.14	0.36
CAL65A	CSS65A	2 1/2	56.5	71	83	0.21	0.58
CAL80A	CSS80A	3	73	71	96	0.26	0.7
CAL100A	CSS100A	4	98	82	127	0.58	1.07
CAL150A	CSS150A	6	150	79	183	0.9	1.66

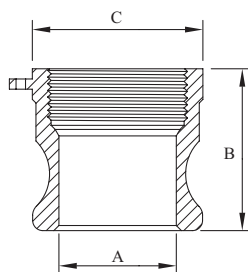

Type B Camlock - Female Camlock X Male BSP

Type B Camlock - Female Camlock X Male BSP								
AAP CODE		IMPERIAL SIZE	A	B	E	G	ALLUMINIUM KG/PC	STAINLESS STEEL KG/PC
ALUMINIUM	STAINLESS STEEL							
CAL15B	CSS15B	1/2	14	48	32	53	0.08	0.14
CAL20B	CSS20B	3/4	14	53	32	53	0.1	0.18
CAL25B	CSS25B	1	24	62	40	60	0.17	0.25
CAL32B	CSS32B	1 1/4	28	66	48	78	0.21	0.38
CAL40B	CSS40B	1 1/2	35	71	49	85	0.24	0.44
CAL50B	CSS50B	2	51	77	54	96	0.28	0.68
CAL65B	CSS65B	2 1/2	58	85	59	110	0.44	0.81
CAL80B	CSS80B	3	72	92	60	127	0.56	1.13
CAL100B	CSS100B	4	98	95	62	156	0.99	1.54
CAL150B	CSS150B	6	150	102	62	240	1.76	3.2

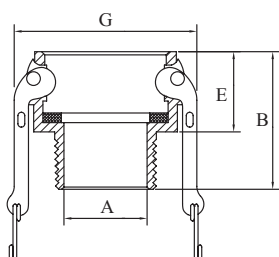

Type C Camlock - Female Camlock X Male Hosebarb

Type C Camlock - Female Camlock X Male Hosebarb									
AAP CODE		IMPERIAL SIZE	A	B	D	E	G	ALLUMINIUM KG/PC	STAINLESS STEEL KG/PC
ALUMINIUM	STAINLESS STEEL								
CAL15C	CSS15C	1/2	14	71	20	32	53	0.08	0.13
CAL20C	CSS20C	3/4	14	84	20	32	53	0.12	0.19
CAL25C	CSS25C	1	20	98	26	40	60	0.19	0.29
CAL32C	CSS32C	1 1/4	25	103	33	48	78	0.28	0.46
CAL40C	CSS40C	1 1/2	31	121	39	49	85	0.3	0.56
CAL50C	CSS50C	2	43	138	52	54	96	0.45	0.72
CAL65C	CSS65C	2 1/2	55	149	65	59	110	0.53	1.08
CAL80C	CSS80C	3	67	160	77	60	127	0.72	1.56
CAL100C	CSS100C	4	92	170	103	62	156	1.01	2.26
CAL150C	CSS150C	6	140	230	150	62	240	2.03	4.22

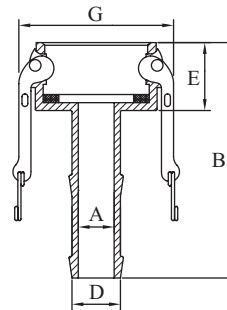

Type D Camlock - Female Camlock X Female BSP

Type D Camlock - Female Camlock X Female BSP									
AAP CODE		IMPERIAL SIZE	A	B	C	E	G	ALLUMINIUM KG/PC	STAINLESS STEEL KG/PC
ALUMINIUM	STAINLESS STEEL								
CAL15D	CSS15D	1/2	16	47	32	32	53	0.09	0.12
CAL20D	CSS20D	3/4	19	53	32	32	53	0.12	0.18
CAL25D	CSS25D	1	26	60	40	40	60	0.14	0.25
CAL32D	CSS32D	1 1/4	30	71	48	48	78	0.29	0.41
CAL40D	CSS40D	1 1/2	39	73	56	49	85	0.27	0.51
CAL50D	CSS50D	2	50	76	67	54	96	0.31	0.62
CAL65D	CSS65D	2 1/2	58	84	83	59	110	0.43	0.82
CAL80D	CSS80D	3	72	89	96	60	127	0.5	1.21
CAL100D	CSS100D	4	98	94	127	62	156	1.01	1.73
CAL150D	CSS150D	6	140	99	175	62	240	2	3.44

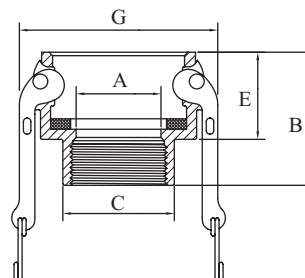

Type E Camlock - Male Camlock X Male Hosebarb

Type E Camlock - Male Camlock X Male Hosebarb									
AAP CODE		IMPERIAL SIZE	A	B	D	E	C	ALLUMINIUM KG/PC	STAINLESS STEEL KG/PC
ALUMINIUM	STAINLESS STEEL								
CAL15E	CSS15E	1/2	14	72	20	40	34	0.03	0.07
CAL20E	CSS20E	3/4	19	88	20	40	34	0.06	0.15
CAL25E	CSS25E	1	24	102	26	46	38	0.09	0.22
CAL32E	CSS32E	1 1/4	28	108	33	53	48	0.14	0.36
CAL40E	CSS40E	1 1/2	35	129	39	56	56	0.2	0.49
CAL50E	CSS50E	2	48	136	52	61	66	0.25	0.69
CAL65E	CSS65E	2 1/2	58	159	65	65	80	0.43	1.13
CAL80E	CSS80E	3	72	166	77	66	102	0.5	1.5
CAL100E	CSS100E	4	98	177	103	70	132	0.82	2.25
CAL150E	CSS150E	6	140	250	150	75	175	2.28	5.8

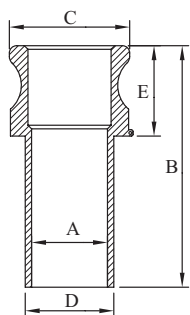

Type F Camlock - Male Camlock X Male BSP

Type F Camlock - Male Camlock X Male BSP									
AAP CODE		IMPERIAL SIZE	A	B	C	E	ALLUMINIUM KG/PC	STAINLESS STEEL KG/PC	
ALUMINIUM	STAINLESS STEEL								
CAL15F	CSS15F	1/2	21	60	32	39	0.03	0.06	
CAL20F	CSS20F	3/4	21	61	32	39	0.06	0.13	
CAL25F	CSS25F	1	24	71	40	48	0.09	0.19	
CAL32F	CSS32F	1 1/4	28.5	81	48	56	0.16	0.32	
CAL40F	CSS40F	1 1/2	36	79	56	61	0.19	0.43	
CAL50F	CSS50F	2	45	87	67	62	0.26	0.57	
CAL65F	CSS65F	2 1/2	56.5	97	83	69	0.44	0.69	
CAL80F	CSS80F	3	73	100	96	74	0.48	1.19	
CAL100F	CSS100F	4	98	114	127	79	0.96	1.84	
CAL150F	CSS150F	6	150	118	175	77	1.52	2.98	

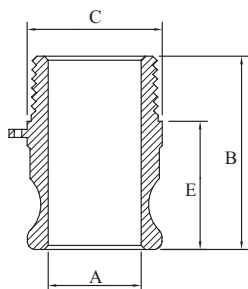

Type DC Camlock - Dust Cap

Type DC Camlock - Dust Cap							
AAP CODE		IMPERIAL SIZE	B	E	G	ALLUMINIUM KG/PC	STAINLESS STEEL KG/PC
ALUMINIUM	STAINLESS STEEL						
CAL15DC	CSS15DC	1/2	37	32	53	0.07	0.13
CAL20DC	CSS20DC	3/4	45	32	53	0.1	0.18
CAL25DC	CSS25DC	1	57	40	60	0.17	0.23
CAL32DC	CSS32DC	1 1/4	65	48	78	0.19	
CAL40DC	CSS40DC	1 1/2	65	49	85	0.22	0.41
CAL50DC	CSS50DC	2	70	54	96	0.26	0.53
CAL65DC	CSS65DC	2 1/2	74	59	110	0.41	0.69
CAL80DC	CSS80DC	3	80	60	127	0.57	1.00
CAL100DC	CSS100DC	4	80	62	156	0.88	1.42
CAL150DC	CSS150DC	6	90	62	240	1.6	2.7

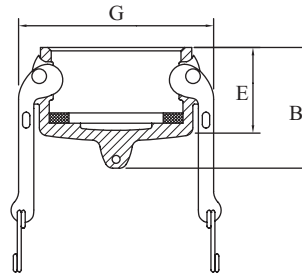

Type DP Camlock - Dust Plug

Type DP Camlock - Dust Plug							
AAP CODE		IMPERIAL SIZE	A	B	E	ALLUMINIUM KG/PC	STAINLESS STEEL KG/PC
ALUMINIUM	STAINLESS STEEL						
CAL15DP	CSS15DP	1/2	21	36	24	0.02	0.05
CAL20DP	CSS20DP	3/4	21	38	24	0.03	0.07
CAL25DP	CSS25DP	1	24	50	30	0.05	0.12
CAL32DP	CSS32DP	1 1/4	29	55	38	0.09	0.22
CAL40DP	CSS40DP	1 1/2	36	59	41	0.11	0.29
CAL50DP	CSS50DP	2	45	64	43	0.17	0.42
CAL65DP	CSS65DP	2 1/2	57	68	45	0.23	0.56
CAL80DP	CSS80DP	3	73	70	52	0.26	0.77
CAL100DP	CSS100DP	4	98	76	48	0.58	1.21
CAL150DP	CSS150DP	6	155	85	62	1.29	2.9

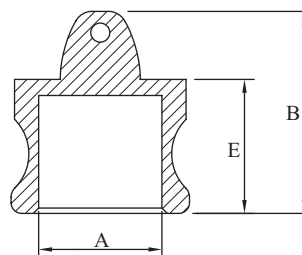

Type A Camlock - Male Camlock X Female BSP

Type A Camlock - Male Camlock X Female BSP							
AAP CODE		IMPERIAL SIZE	A	B	C	NYGLASS KG/PC	POLY KG/PC
NYGLASS	POLY						
CNG20A	CPP20A	3/4	21	41	32	0.02	0.02
CNG25A	CPP25A	1	24	52	40	0.03	0.03
CNG32A	CPP32A	1 1/4	28.5	54	48	0.04	0.04
CNG40A	CPP40A	1 1/2	36	57	56	0.07	0.07
CNG50A	CPP50A	2	45	62	67	0.11	0.10
CNG80A	CPP80A	3	73	71	96	0.20	0.19

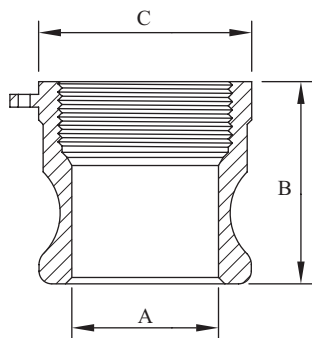

Type B Camlock - Female Camlock X Male BSP

Type B Camlock - Female Camlock X Male BSP								
AAP CODE		IMPERIAL SIZE	A	B	E	G	NYGLASS KG/PC	POLY KG/PC
NYGLASS	POLY							
CNG20B	CPP20B	3/4	14	53	32	53.00	0.08	0.08
CNG25B	CPP25B	1	24	62	40	60.00	0.11	0.11
CNG32B	CPP32B	1 1/4	28	66	48	78	0.17	0.17
CNG40B	CPP40B	1 1/2	35	71	49	85.00	0.19	0.19
CNG50B	CPP50B	2	51	77	54	96.00	0.23	0.22
CNG80B	CPP80B	3	72	92	60	127.00	0.38	0.36

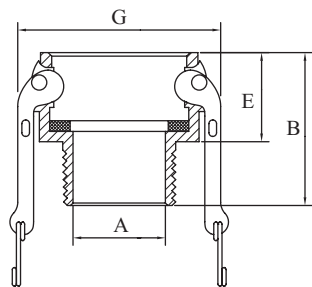

Type C Camlock - Female Camlock X Male Hosebarb

Type C Camlock - Female Camlock X Male Hosebarb									
AAP CODE		IMPERIAL SIZE	A	B	D	E	G	NYGLASS KG/PC	POLY KG/PC
NYGLASS	POLY								
CNG20C	CPP20C	3/4	14	84	20	32.00	53.00	0.08	0.08
CNG25C	CPP25C	1	20	98	26	40.00	60.00	0.12	0.12
CNG32C	CPP32C	1 1/4	25	103	33	48	78	0.17	0.17
CNG40C	CPP40C	1 1/2	31	121	39	49.00	85.00	0.21	0.21
CNG50C	CPP50C	2	43	138	52	54.00	96.00	0.28	0.27
CNG80C	CPP80C	3	67	160	77	60.00	127.00	0.46	0.44

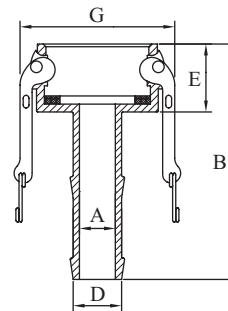

Type D Camlock - Female Camlock X Female BSP

Type D Camlock - Female Camlock X Female BSP									
AAP CODE		IMPERIAL SIZE	A	B	C	E	G	NYGLASS KG/PC	POLY KG/PC
NYGLASS	POLY								
CNG20D	CPP20D	3/4	19	53	32	32.00	53.00	0.08	0.08
CNG25D	CPP25D	1	26	60	40	40.00	60.00	0.12	0.12
CNG32D	CPP32D	1 1/4	30	71	48	48	78	0.17	0.17
CNG40D	CPP40D	1 1/2	39	73	56	49.00	85.00	0.22	0.22
CNG50D	CPP50D	2	50	76	67	54.00	96.00	0.24	0.23
CNG80D	CPP80D	3	72	89	96	60.00	127.00	0.40	0.38

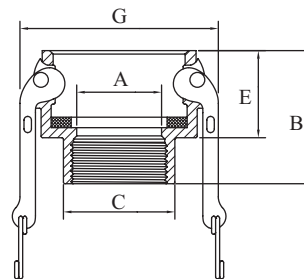

Type E Camlock - Male Camlock X Male Hosebarb

Type E Camlock - Male Camlock X Male Hosebarb									
AAP CODE		IMPERIAL SIZE	A	B	D	E	C	NYGLASS KG/PC	POLY KG/PC
NYGLASS	POLY								
CNG20E	CPP20E	3/4	19	88	20	40.00	34.00	0.03	0.03
CNG25E	CPP25E	1	24	102	26	46.00	38.00	0.05	0.045
CNG32E	CPP32E	1 1/4	28	108	33	53	48	0.06	0.06
CNG40E	CPP40E	1 1/2	35	129	39	56.00	56.00	0.09	0.09
CNG50E	CPP50E	2	48	136	52	61.00	66.00	0.15	0.1425
CNG80E	CPP80E	3	72	166	77	66.00	102.00	0.30	0.28025

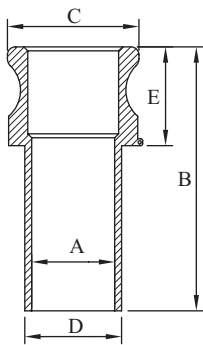

Type F Camlock - Male Camlock X Male BSP

Type F Camlock - Male Camlock X Male BSP								
AAP CODE		IMPERIAL SIZE	A	B	C	E	NYGLASS KG/PC	POLY KG/PC
NYGLASS	POLY							
CNG20F	CPP20F	3/4	21	61	32	39.00	0.03	0.03
CNG25F	CPP25F	1	24	71	40	48.00	0.04	0.04
CNG32F	CPP32F	1 1/4	28.5	81	48	56	0.06	0.06
CNG40F	CPP40F	1 1/2	36	79	56	61.00	0.09	0.09
CNG50F	CPP50F	2	45	87	67	62.00	0.16	0.15
CNG80F	CPP80F	3	73	100	96	74.00	0.26	0.25

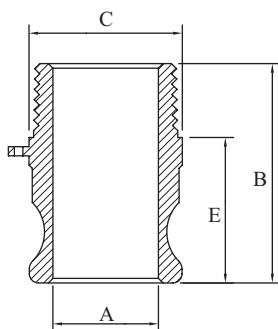

Type DC Camlock - Dust Cap

AAP CODE		IMPERIAL SIZE	B	E	G	NYGLASS KG/PC	POLY KG/PC
NYGLASS	POLY						
CNG20DC	CPP20DC	3/4	45	32	53	0.08	0.08
CNG25DC	CPP25DC	1	57	40	60	0.11	0.11
CNG32DC	CPP32DC	1 1/4	65	48	78	0.16	0.16
CNG40DC	CPP40DC	1 1/2	65	49	85	0.18	0.18
CNG50DC	CPP50DC	2	70	54	96	0.22	0.22
CNG80DC	CPP80DC	3	80	60	127	0.36	0.36

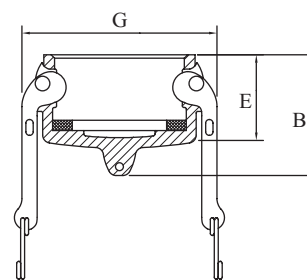

Type DP Camlock - Dust Plug

AAP CODE		IMPERIAL SIZE	A	B	E	NYGLASS KG/PC	POLY KG/PC
NYGLASS	POLY						
CNG20DP	CPP20DP	3/4	21	38	24	0.02	0.02
CNG25DP	CPP25DP	1	24	50	30	0.03	0.03
CNG32DP	CPP32DP	1 1/4	29	55	38	0.05	0.05
CNG40DP	CPP40DP	1 1/4	36	59	41	0.06	0.06
CNG50DP	CPP50DP	2	45	64	43	0.09	0.09
CNG80DP	CPP80DP	3	73	70	52	0.15	0.14

