









Model Code: EN100L

Included Accessories

 Inset Clip	 6020	 Seal Strip

Optional Accessories

 DBR10S	 AQCB	 ADT1
 DR006		

Dimensions

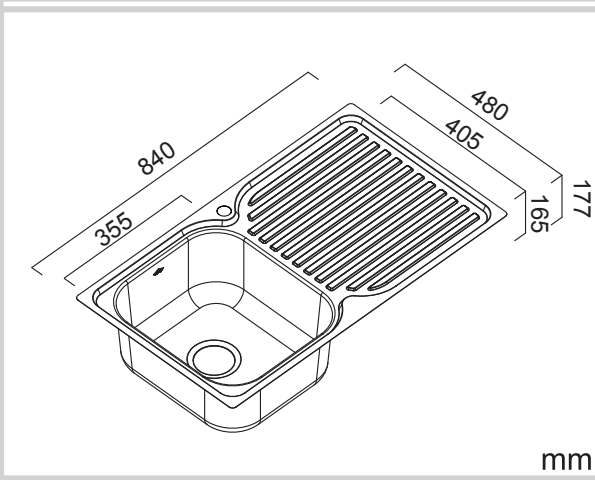

Specifications

Description	Single bowl with one Drainer, inset sink
Overall Sink Size	840mm x 480mm x 177mm deep
Bowl Dimensions	355mm x 405mm x 165mm deep
Drainer Length	423mm
Technic	Pressed
Material	Stainless steel SUS304

Installation

Fixings	Inset clips supplied
Template	Supplied
Min Cabinet Size	425mm
Waste Holes	1 x 90mm round Compatible with waste disposal

SURFACE FINISH

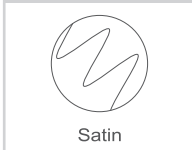

WASTE KIT

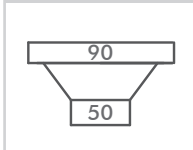

MATERIAL



Plumbing

Waste Fittings	1 x (90mm x 2") basket waste included
Overflow	Available, conditions apply

INSTALLATION OPTIONS

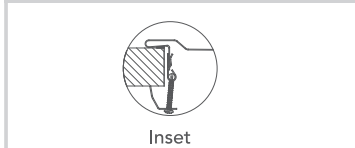

PROFILE

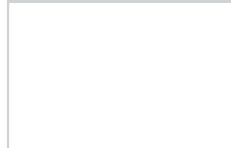

Packaging

Carton Type	EPS protection & individual sleeve
Gross Weight	2.928Kg
Carton Size	890mm x 535mm x 207mm
Pack QTY	1

Abey are Australia's leaders in sinkware, designing and manufacturing to the world's highest quality specifications as well as sourcing and bringing you Europe's very best, leading edge designs – practical, affordable, inspirational, stylish, timeless or cutting edge. When you buy an Abey stainless steel sink you receive the highest quality and a 25 year warranty. Abey and the manufacturer are continually seeking ways to improve the design specifications, aesthetic and production techniques of the products. As a result, alterations to the specifications and dimensions of the products and designs occur continually.