

MIRO 900D

PRODUCT CODE
M90D

LED MIRROR

SPECIFICATIONS	
WIDTH	900mm
HEIGHT	700mm
DEPTH	30mm
WEIGHT	15kg
ORIENTATION	Landscape

FEATURES
Copper Free Mirror
LED Lighting (Adjustable Colour Temperature)
Touch Sensor
Demister with 1 Hour Auto Cut-off

LIGHTING SPECIFICATIONS	
CCT	2700K - 6500K
CRI	>80

INSTALLATION	
Wall mount	
Hardwire	
Input voltage: 220-240v 50Hz	

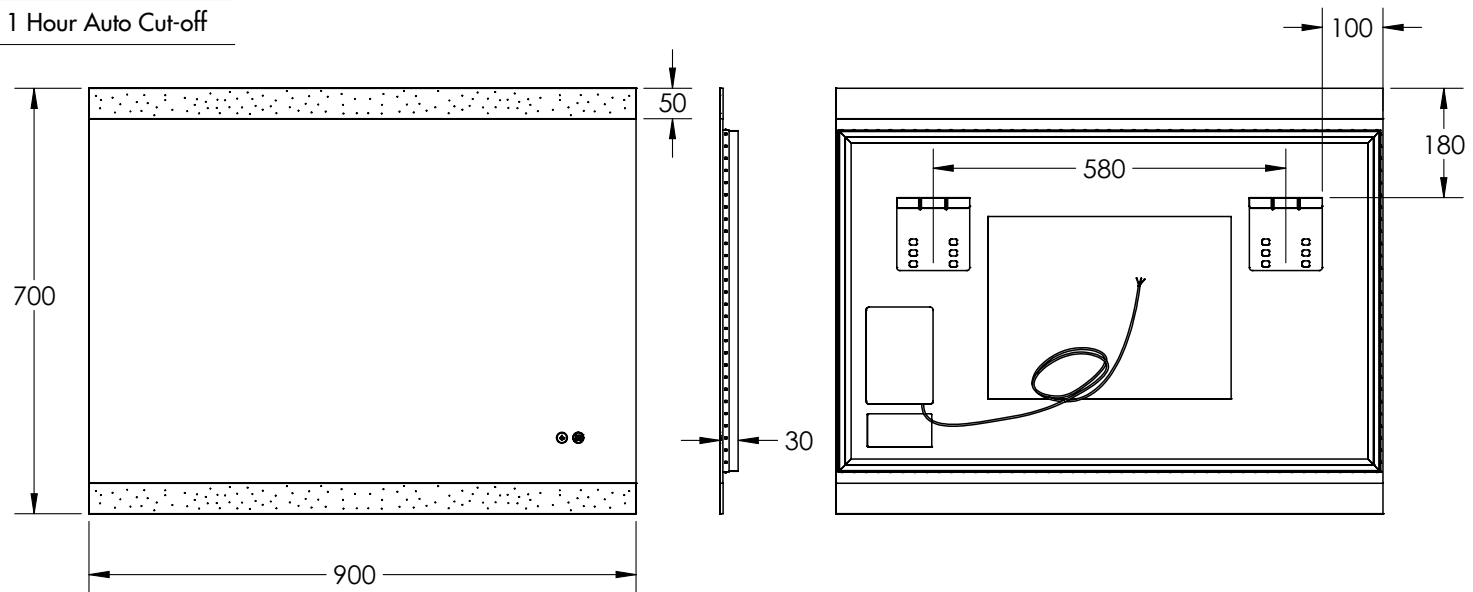

Disclaimer: All LED Products requiring hardwiring must be installed by a licensed electrician in accordance with local regulations. Sizes are in mm and nominal and should be checked prior to installation. Actual colours may vary so please check colour samples before ordering. Installation is acceptance of our products. Installation of faulty, warped, chipped or damaged products will void our warranty.

MIRO 900D

PRODUCT CODE
M90D

LED MIRROR

SPECIFICATIONS	
WIDTH	900mm
HEIGHT	700mm
DEPTH	35mm
WEIGHT	15kg
ORIENTATION	Landscape

FEATURES	
Copper Free Mirror	
LED Lighting (Adjustable Colour Temperature)	
Touch Sensor	
Demister with 1 Hour Auto Cut-off	

LIGHTING SPECIFICATIONS	
CCT	2700K - 6500K
CRI	>80

INSTALLATION	
Wall mount	
Hardwire / Plug	
Input voltage: 220-240v 50Hz	

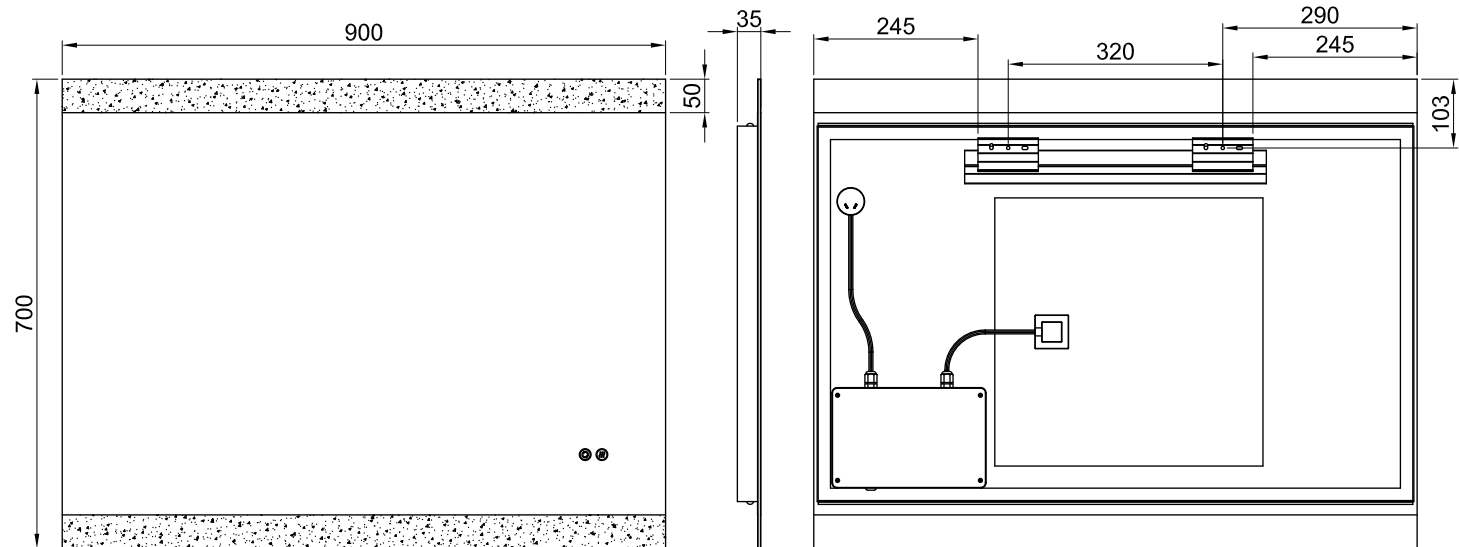

Disclaimer: All LED Products requiring hardwiring must be installed by a licensed electrician in accordance with local regulations. Sizes are in mm and nominal and should be checked prior to installation. Actual colours may vary so please check colour samples before ordering. Installation is acceptance of our products. Installation of faulty, warped, chipped or damaged products will void our warranty.