

OX[®]

CATALOGUE
EDITION 9



BORN IN
AUSTRALIA.
RAISED IN
AUSTRALIA.

oxtools.com



FIND US AT:

www.oxtools.com.au



facebook.com/oxtools



youtube.com/c/OXTOOLS1975



instagram.com/oxtoolsau

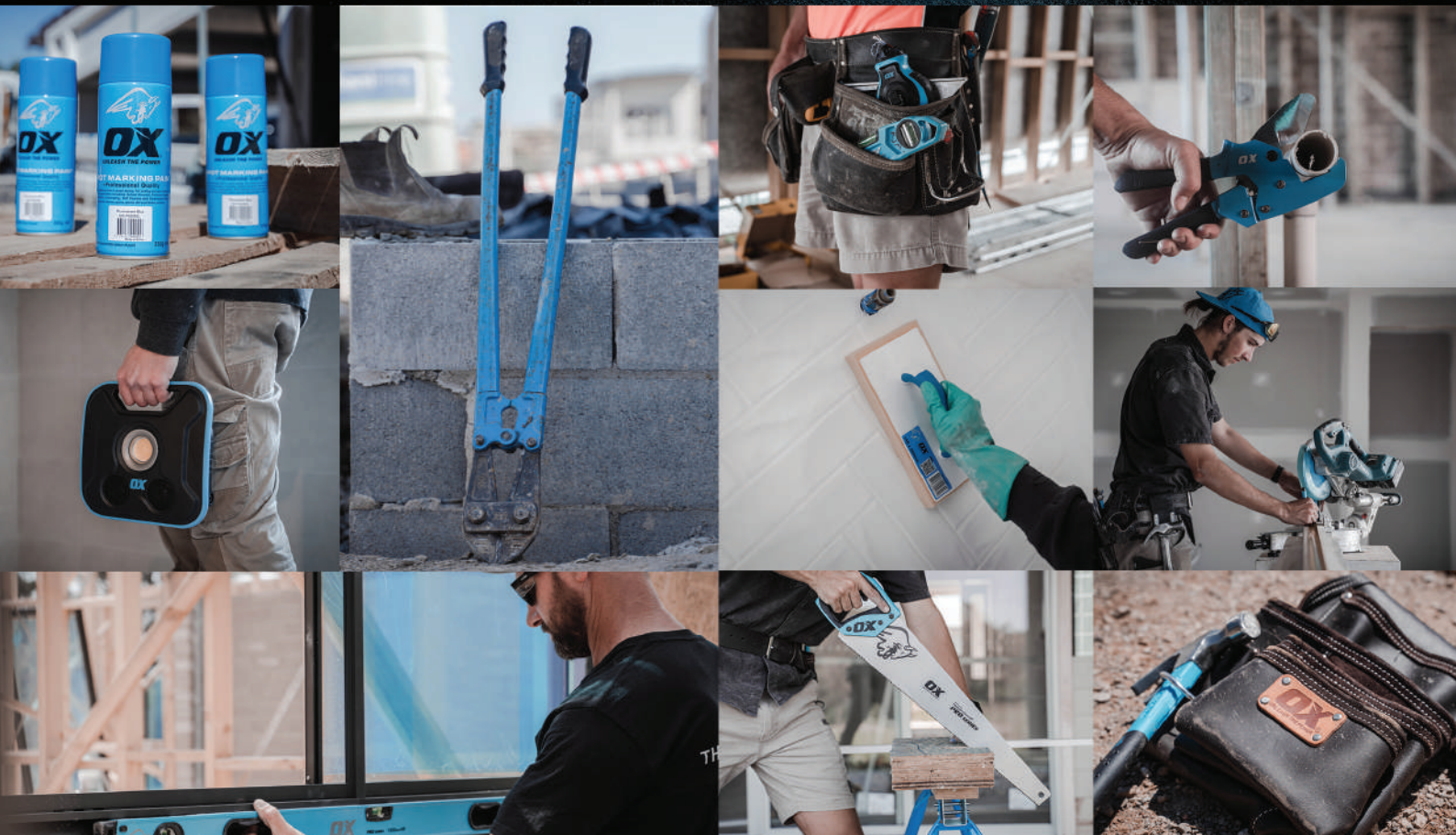

Contents



Diamond Tools
pages 14-43



Concreting Tools
pages 44-69



Bricklaying Tools
pages 70-79



Plastering & Rendering Tools
pages 80 - 97



Tiling Tools
pages 98 - 111



Striking & Struck Tools
pages 112 - 125



Measuring Tools
pages 126 - 131



Layout Tools
pages 132 - 141



Woodworking Tools
pages 142 - 147



Cutting Tools
pages 148 - 153



Plumbing & Electrical Tools
pages 154 - 159



Site Tools & Accessories
pages 160 - 169



Tool Storage
pages 170 - 177



Safety Equipment
pages 178 - 189

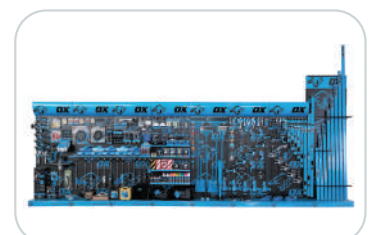

Merchandising
pages 190 - 192

18 offices, 15 countries, one **OX**

Our Story

OX Tools is a world leading supplier of hand tools, diamond tools and safety products.

Developed and proven in Australia over the past 47 years, our tools are recognized as tough, dynamic and different across the globe.

As a supplier of professional tools we sell direct to merchants, providing them with excellent service, innovative merchandising solutions and a very powerful brand.



- OX UK -**
Europe/Middle East
- France
 - Spain
 - Sweden
 - The Netherlands
 - Malta
 - Italy
 - Finland
 - Saudi Arabia
 - Argentina
 - United Arab

- OX Australia -**
Australasia/Asia Pacific
- New Zealand

- OX USA -**
North America
- Canada



EASY TO USE ONLINE ORDERING SYSTEM



You can place your order on the move or wherever you are, via any desktop, smart phone and tablet device.

DEALER E-COMMERCE NOW AVAILABLE!

To login please visit: shop.oxtools.com



Shop by tool category or search for products that fit your needs.



Track & check on the status of your order.



See your pricing.



View your order history.



Place orders and check with your purchase order number



View your promotions & special pricing.

NO BULL. JUST OX.



IT'S EASIER TO DO BUSINESS WITH US!

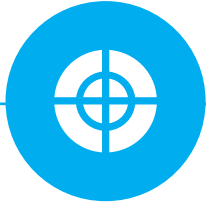

ORDER ACCURACY

99.5 PERCENT

OF ORDERS ARE
DELIVERED
CORRECT



QUICK ANSWERING

2.5 SECONDS

AVERAGE PHONE
CALL PICK UP
TIME



FAST DISPATCH

12 PM

SAME DAY DISPATCH
IF ORDERED BEFORE 12PM



shop.oxtools.com

Online ordering made easy, desktop or mobile.

Fast, secure ordering with our user-friendly store



sales.au@oxtools.com

Anytime! 24 hours - 7 days a week.



P: (02) 8845 6600

8:00 am to 5:00 pm AEST
Monday to Friday

Our friendly, professional staff are ready to help.

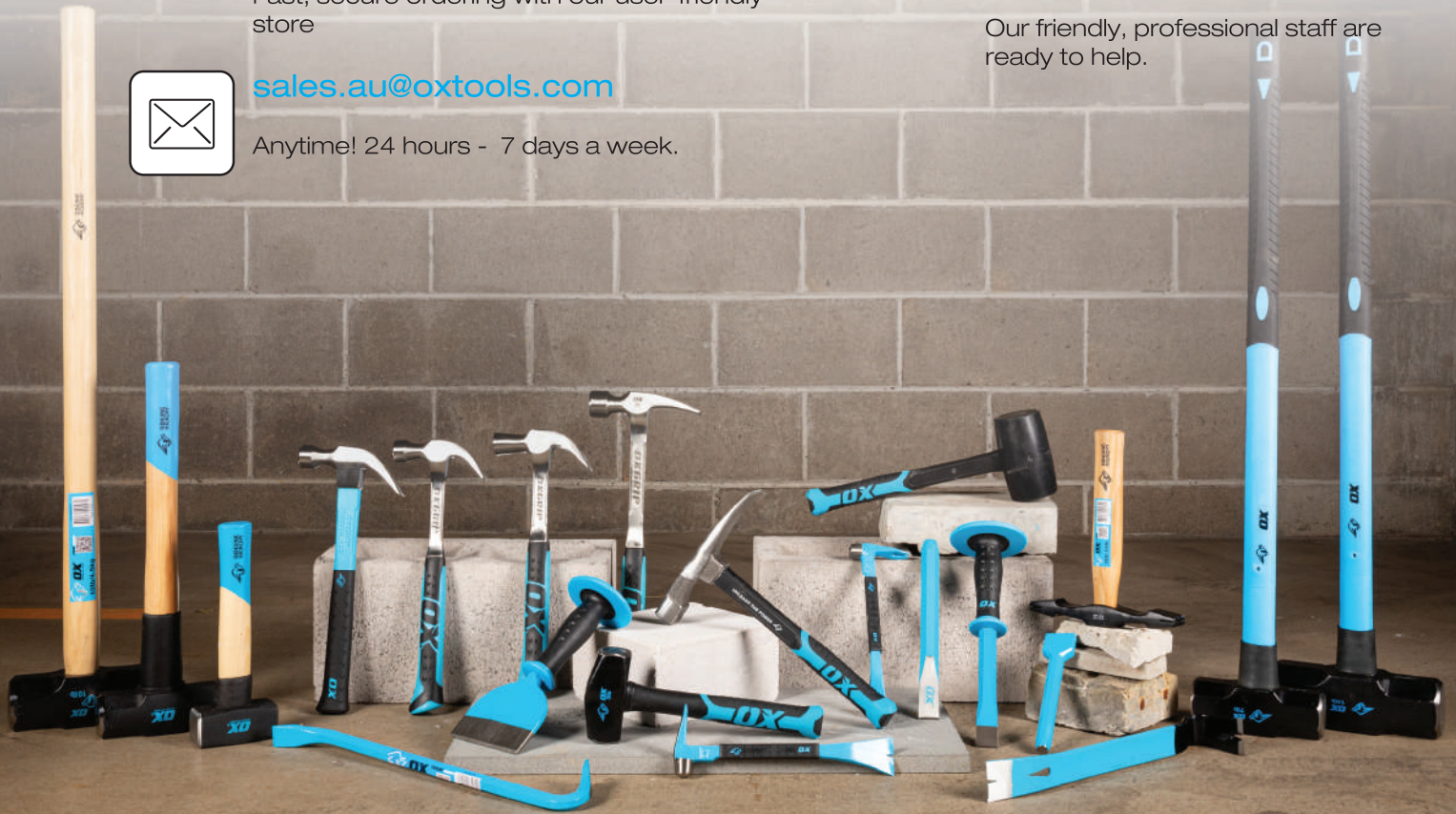



World Leading Technology...



Intricate detail of the products – the strength and thickness of the steel, the perfect weight & balance, the positioning of the handles – guaranteed better than the rest!



Packed with innovation, OX tools raise the benchmark for tool performance to unprecedented new levels.



A blade guaranteed to cut all construction products, including steel.

OX diamond blades deliver reliability, consistency and performance everyday on the construction site.

visit oxtools.com to find out more...

Whatever the level of merchandising support you need we have the answer!

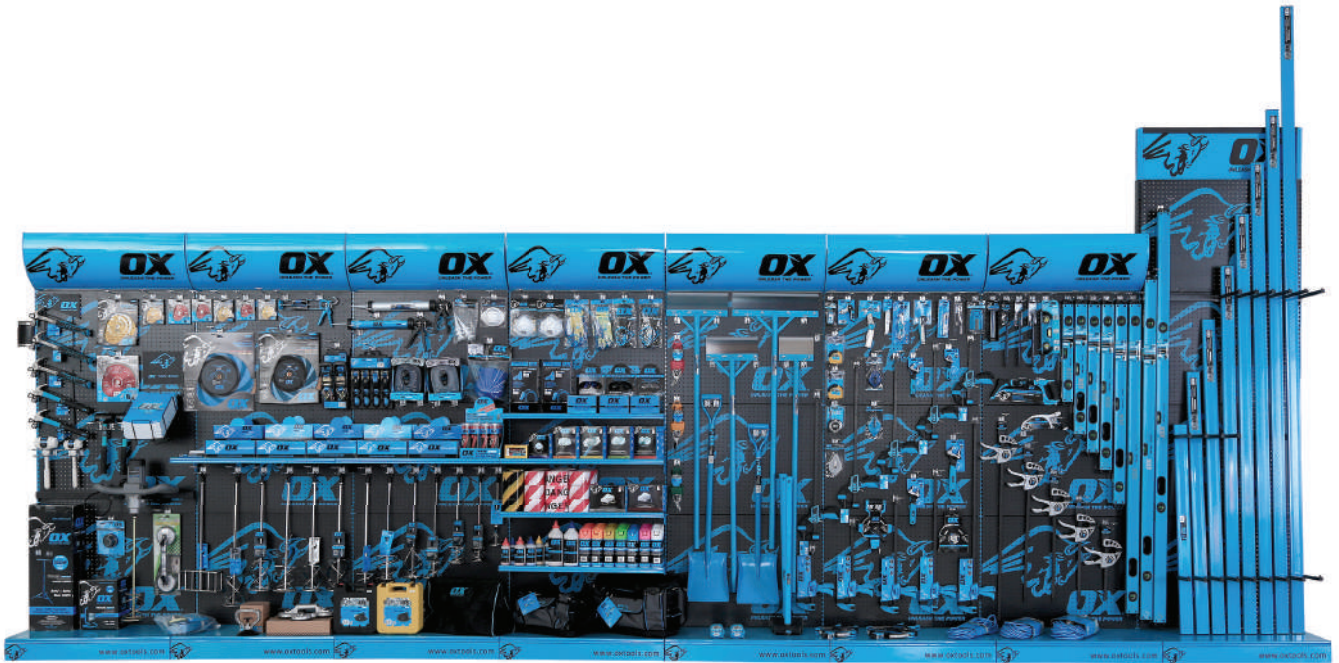

Full Back Up Support



Staff training



Service & support on site



Demonstrations & trade shows



Marketing & sell through

Live the Trade





New innovative tool development

With 47 years of experience, and product and marketing innovation, we deliver ingenious design solutions to meet ever-evolving customer requirements.

The functionality, durability and innovation of our tools are led by the need to meet the high expectations of professional users on the jobsite.

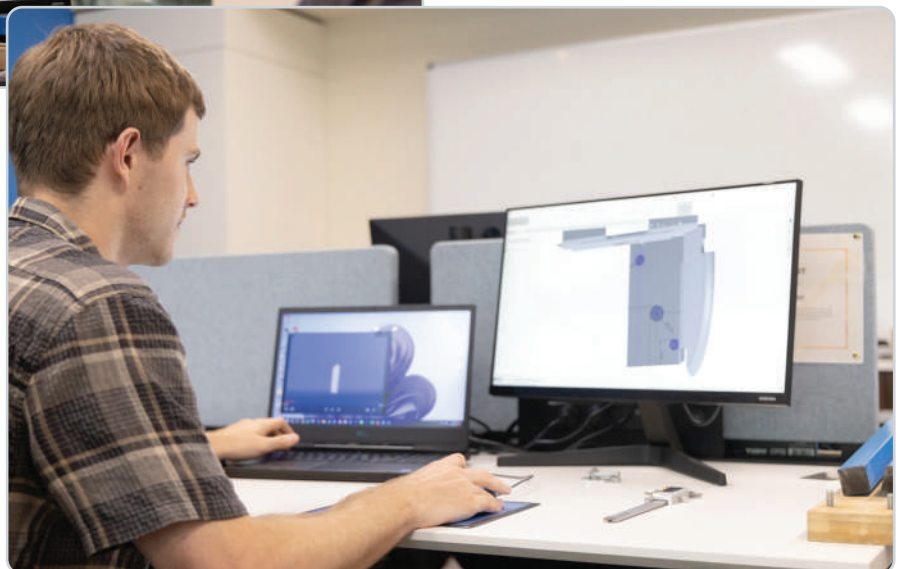
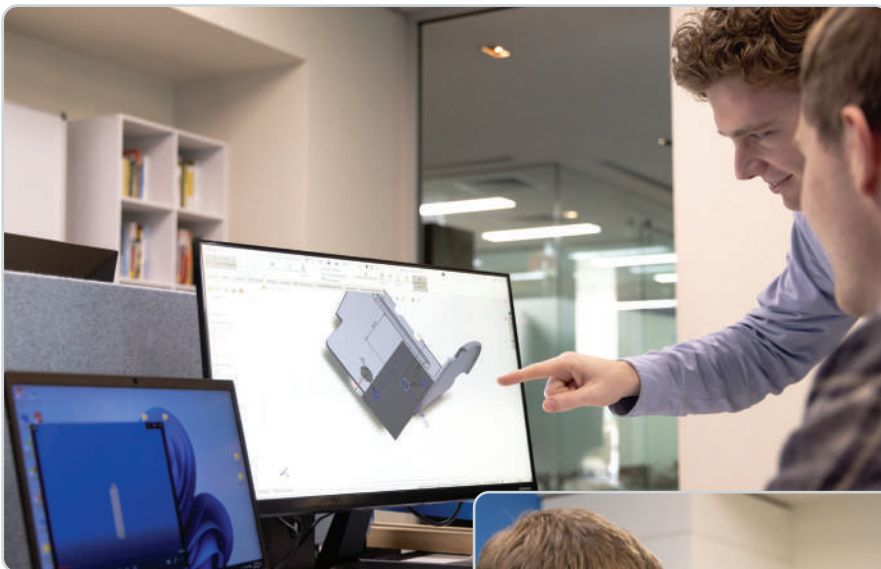



BUILDING A BETTER TOMORROW

A GREENER BRAND...

The commitments made by OX Tools to ensure a more sustainable future cover 6 core areas: vehicles fuel, printing & ink, packaging, recycling, lighting & electrical and shipping. We are committed to reducing waste and becoming a more sustainable brand.

We are proud to be transparently transforming the OX of today to ensure there is an OX of tomorrow. The greener, blue brand.

OUR COMMITMENT

We are committed to minimizing our environmental impact to sustain the world we live in together.



PACKAGING
MORE SUSTAINABLE
PACKAGING MATERIALS



VEHICLES & FUEL
GREENER MORE EFFICIENT
VEHICLE FLEET.



PRINTING & INK
MORE SUSTAINABLE
PRINTING SOLUTIONS



RECYCLING
INCREASING RECYCLED
MATERIALS AND REDUCING
WASTE



ELECTRICAL
TECHNOLOGICAL SOLUTIONS
TO REDUCE ELECTRICAL
CONSUMPTION



SHIPPING
CONSOLIDATED SHIPMENTS
AND REDUCING WASTE IN
TRANSPORTATION

PACKAGING

We are committed to a lifecycle approach to the use of our packaging. Over 5 million products pass through the OX Tools AU warehouse every year. Every product requires well-designed, efficiently packed, appropriately used and responsibly disposed of packaging.

In early 2021 we introduced only brown cardboard packaging boxes. This material is recyclable, renewable and sustainable.

We also actively engage with our factories across the globe to develop more environmentally sustainable packaging options. In cases where plastic was being used, we are transitioning to card and for the plastic still in use we are reducing single use packaging where possible and moving towards recycled plastic.



REDUCING
excessive and
inappropriate
use of materials.



RECYCLING
waste material to
ensure a closed
loop system.



OPTIMIZING
shipments ensuring
boxes are loaded to
capacity without
risking damage.





New Products

PRO TUFF RULE

- 0.5mm marked increments
- Highlighted increments
- Engineered ABS plastic
- Center line feature
- Central Swivel Hinge = easy angle finder 0-180°

Page 131



TUFF CARBON MARKING PENCIL

- Belt clip
- Long life automatic marking pencil - automatic lead feed
- Made of high quality PP/ABS/stainless steel
- Fitted with ABS protection cap for the lead protection
- Stainless steel lead feed tube - diameter of lead 2.8mm
- Integrated lead sharpener built into the cap



Page 140



Page 137

PRO ALUMINIUM KEVLAR® CHALK LINE REEL AND REFILL

- Designed to withstand job site conditions
- Built with Kevlar®, stronger than standard lines
- Bold, clear, definitive lines
- 6:1 gear ratio for faster rewind
- Strongest line on the market
- Chalk Included



Page 134

PRO TUFF LEVEL

- Built and designed for the toughest work site conditions
- Ultra-precise level vials calibrated to 0.005"/" (0.5mm/m)
- Fine milled surface along top and bottom for 100% precision
- Easy to clean profile
- Easy grip ribbed profile
- Strong, lightweight aluminium profile
- High impact 9mm rubber end caps
- Sizes: 600mm, 800mm, 1200mm, 2000mm

PRO ALUMINIUM RAFTER SQUARE

- Scribe notches for marking 5mm increments
- Easy read laser-etched markings
- Metric markings and conversion tables
- Extra-thick extruded aluminium body
- Wide base ensures a secure hold on materials
- Sizes: 180mm & 300mm

Page 129

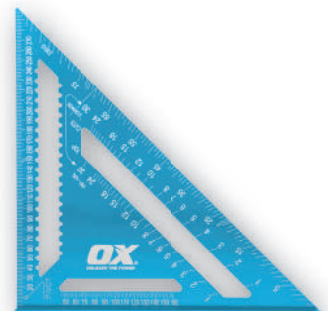



New Products

PRO EASY START HANDSAW

- Teflon Coated Blade (reduces friction/increased cutting efficiency)
- Easy start feature: 8TPI / 13TPI easy start up in soft timber
- 45/90 degree angle finder integrated into handle
- TPR insert
- OX comfort grip handle



Page 152

PRO POLYZIP™ FLEX PIPE CUTTERS - C1 & C2

- Patented flex technology for multi diameter cutting
- Perfect for most popular plumbing pipes and electrical conduits including most flexible conduits
- Ultra-Square cut
- Efficient and precise leaving zero pipe deformation
- Spare blade and safety insert included
- Quick change stainless blade (reversible dual life)
- Zero swarf



Page 155



Page 162

PRO DUAL THRUST CAULKING GUN

- Patented Quick Switch Dual Thrust Ratio 12:1 & 24:1
- Suits 600mm bulk cartridges
- Patented no gaps trigger design
- Twin Heat Treatment Steel Push Plates & 1.5mm Steel Push Piston
- Glass Fibre impregnated body with TPR handle
- Suitable For Low To High Viscosity Materials

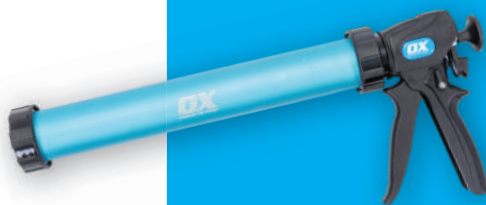

Page 162

PRO DUAL THRUST SEALANT GUN

- Patented Quick Switch Dual Thrust Ratio 12:1 & 24:1
- Glass Fibre impregnated body with TPR handle
- Patented no gaps trigger design
- Patented 360° Barrel Rotary type Anodized Aluminium Barrel
- Patented Quick Fit & Toolless Plunger System (honeycomb design)
- Suitable For Low To High Viscosity Materials

PRO HEAVY DUTY BAR CLAMP

- 300Kg clamping force
- Strong engineering plastics in compliance with RoHS and REACH
- Induction hardened rail for improved strength and durability
- Long leverage design for reaching high pressure faster
- Can be quickly converted to spreader
- Optional version with extended cushions



Page 145

Diamond Tools

“OX Tools Diamond range has served my business well. I have used the OX blades on my Brick Saw for as long as I can remember. On the odd occasion, I have tried other brands as we are always looking for blades that are advanced and ahead of the game. The results always send me back to OX Tools. I have made so many recommendations to fellow bricklayers who have all given me thanks and I've heard nothing other the positive feedback. We now look no further when it comes to blades as we know what we will get with OX every single time.”

Peter Matolic | The Brick Co





World Leading Technology



Only the finest quality of diamond is used in the production of OX blades.



State of the art laser technology for ultimate performance and safety.



Blade & cores are made of the highest quality steel, precision engineered, ground and hardened.

Product Guarantees & Safety

Safety is a fundamental part of the OX Diamond range. It is interwoven into the very fibre of innovation, design and production from concept to after sales service.



EN13236
All blades conform with EN13236 and have this engraved onto the centre of the products



Full 'No Hassle' Guarantee
Covers all OX products



Diamond Innovation
Ongoing development provides increased performance on existing products, and innovative new diamond solutions.



Safety Instructions
Products undergo rigorous safety and vibration testing at our research & development facility, and in the field.



Hand/Arm Vibration
OX products were among the first to be tested and certified safe for hand/arm vibration.



Extra Safe
Our safety policy is an integral part of our company ethos with policies incorporating ISO18001.



Environmental
Showing that we care: Manufacturing operations accredited to ISO 14001 environmental systems.

We have a responsibility. Quality control systems and environmental and safety management ensure that our care covers not only our products and our customers – but that our ethical guidelines address issues such as staff safety and care for the environment.

Refer page [193 - 197](#) for the Diamond Trouble Shooting Guide



RECOMMENDATION GUIDE

For specific advice, refer to your sales representative or customer service.

APPLICATION GUIDE	CU10	CC10	XLT	XL10	TU10	TC10	TB10	TA10	MPS	MPSS	PC10	PB10	PA10
Aerated Concrete	✓✓	✓✓	✓✓	✓✓	✓	✓✓	✓✓	✓✓	✓	✓	✓✓	✓✓	✓✓
Alumina	X	X	X	X	X	X	X	X	X	X	X	X	X
Asphalt / Bitumen	X	X	✓✓	✓	X	X	✓	✓✓	X	X	X	✓	✓✓
Bluestone	X	✓	X	X	✓✓	X	X	X	✓✓	✓✓	✓	X	X
Brick - Clay	X	✓	X	X	✓✓	X	X	X	✓✓	✓✓	X	X	X
Brick - Concrete	✓	✓	✓✓	✓✓	✓	✓✓	✓✓	✓	✓	✓	✓	✓✓	X
Brick - Lightweight	✓✓	✓	✓	✓✓	✓	✓✓	✓✓	✓	✓	✓	✓✓	✓✓	✓
Brick - Refractory	X	✓	X	X	✓	X	X	X	✓✓	✓✓	X	X	X
Ceramic Tiles - General	X	X	X	X	X	X	X	X	X	X	X	X	X
Ceramic Tiles - Fully Vitrified	X	X	X	X	X	X	X	X	X	X	X	X	X
Cement - Sheeting	✓✓	✓	X	✓	✓✓	✓	✓	X	✓✓	✓✓	✓	✓	X
Cement - Block	✓✓	✓	✓✓	✓✓	✓	✓✓	✓✓	✓	✓	✓	✓	✓✓	✓
Cement - Roof Tiles	✓	✓	✓✓	✓✓	✓	✓✓	✓✓	✓	✓	✓	✓	✓✓	✓
Cement - Pipe	✓	✓	X	✓✓	✓	✓✓	✓	X	✓	✓	✓✓	✓	X
Concrete - Cured	✓	✓	✓	✓	✓	✓✓	✓	X	✓	✓	✓✓	✓	X
Concrete - Cured Reinforced	X	X	✓	X	✓	✓✓	✓	X	✓	✓	✓✓	✓	X
Concrete - Green	X	X	✓✓	✓	X	X	✓	✓✓	✓	✓	X	✓	✓✓
Concrete - Lightweight	✓✓	✓✓	✓✓	✓✓	✓	✓✓	✓	✓	✓	✓	✓✓	✓✓	✓
Demolition Work	X	✓	X	X	✓✓	X	X	X	✓✓	✓✓	X	X	X
Engineered Stone	X	X	X	X	X	X	X	X	X	X	X	X	X
Fibreglass	X	X	X	X	✓	X	X	X	✓	X	X	X	X
Fibre Cement Sheet	✓✓	✓✓	X	✓	✓✓	✓	✓	X	✓✓	✓✓	✓	✓	X
Granite	X	✓	X	X	✓✓	X	X	X	✓✓	✓✓	X	X	X
Glass	X	X	X	X	X	X	X	X	X	X	X	X	X
Limestone	X	✓	X	✓	✓✓	X	✓	X	✓✓	✓✓	✓	✓	✓✓
Mortar	X	X	✓	✓✓	X	X	✓	✓✓	X	X	X	✓	X
Marble	X	X	X	X	X	X	X	X	X	X	X	X	X
Porcelain	X	X	X	X	X	X	X	X	X	X	X	X	X
Roof Tiles - Clay	X	✓✓	X	X	✓✓	X	X	X	✓✓	✓✓	✓	X	X
Roof Tiles - Cement	✓	✓	X	✓✓	X	✓	✓✓	X	✓	✓	X	✓✓	✓
Sandstone	✓	✓	✓✓	✓	✓	✓	✓✓	✓✓	✓	✓	✓	✓✓	✓✓
Slate	✓	✓✓	✓	X	✓✓	X	✓	X	✓✓	✓✓	✓✓	✓	X
Steel	X	X	X	X	✓	X	X	X	✓	X	X	X	X
Terracotta	X	X	X	X	X	X	X	X	X	X	X	X	X
Terrazzo	X	X	X	X	X	X	X	X	X	X	X	X	X
Wall Chasing	✓	X	X	✓	✓	✓	✓	X	X	X	✓	✓	X
LEGEND	Will Cut Well		✓✓		Will Cut			✓	Will Not Cut			X	



Refer page 193 - 197 for the Diamond Trouble Shooting Guide

APPLICATION GUIDE		MPSS	PHB	PCB	PSB	PHBS	PCBS	PSBS	PSF
Aerated Concrete		✓	✓	✓	✓✓	✓	✓	✓✓	✓
Alumina		✗	✗	✗	✗	✗	✗	✗	✗
Asphalt / Bitumen		✓	✗	✗	✗	✗	✗	✗	✓✓
Bluestone		✓	✓✓	✓	✗	✓✓	✓	✗	✗
Brick - Clay		✓✓	✓✓	✓	✗	✓✓	✓	✗	✗
Brick - Concrete		✓	✗	✓	✓✓	✗	✓	✓✓	✓✓
Brick - Lightweight		✓	✗	✓	✓✓	✗	✓	✓✓	✓✓
Brick - Refractory		✓	✗	✗	✗	✗	✗	✗	✗
Ceramic Tiles - General		✓	✗	✗	✗	✗	✗	✗	✗
Ceramic Tiles - Fully Vitrified		✓	✗	✗	✗	✗	✗	✗	✗
Cement - Sheeting		✓✓	✓	✓	✓	✓	✓	✓	✓
Cement - Block		✓	✗	✓	✓✓	✗	✓	✓✓	✓✓
Cement - Roof Tiles		✓	✗	✓	✓✓	✗	✓	✓✓	✓
Cement - Pipe		✓	✓	✓	✓	✓	✓	✓	✓
Concrete - Cured		✓	✓	✓	✓	✓	✓	✓	✓
Concrete - Cured Reinforced		✓	✓	✓	✓	✓	✓	✓	✓
Concrete - Green		✓	✗	✗	✓	✗	✗	✓	✓✓
Concrete - Lightweight		✓	✗	✓	✓	✗	✓	✓	✓✓
Demolition Work		✓✓	✗	✓	✗	✗	✓	✗	✓
Engineered Stone		✓	✓	✓	✓	✓	✓	✓	✗
Fibreglass		✗	✗	✗	✗	✗	✗	✗	✗
Fibre Cement Sheet		✓✓	✓	✓	✓	✓	✓	✓	✓
Granite		✓✓	✓	✗	✗	✓	✗	✗	✗
Glass		✗	✗	✗	✗	✗	✗	✗	✗
Limestone		✓	✗	✓	✓✓	✗	✓	✓✓	✓✓
Mortar		✓	✗	✓	✓	✗	✗	✗	✓
Marble		✓	✗	✗	✗	✗	✗	✗	✗
Porcelain		✓	✗	✗	✗	✗	✗	✗	✗
Roof Tiles - Clay		✓✓	✓✓	✓	✗	✓✓	✓	✗	✗
Roof Tiles - Cement		✓	✗	✓	✓✓	✗	✓	✓✓	✓✓
Sandstone		✓	✗	✗	✓✓	✗	✗	✓✓	✓✓
Slate		✓✓	✓✓	✓	✓	✓✓	✓	✓	✗
Steel		✗	✗	✗	✗	✗	✗	✗	✗
Terracotta		✓	✓✓	✓	✗	✓✓	✓	✗	✗
Terrazzo		✓	✗	✓	✓✓	✗	✓	✓✓	✗
Wall Chasing		✓	✓	✓	✓	✓	✓	✓	✗
LEGEND	Will Cut Well	✓✓	Will Cut		✓	Will Not Cut		✗	



Blade Selection & Presentation

Blade category clearly listed

Equipment suitable for the blade

Size indicator

Blade details

Blade material applications

Blade appearance and rim type visible

Application chart showing products available in each category

Full safety instructions for usage

Performance Classes

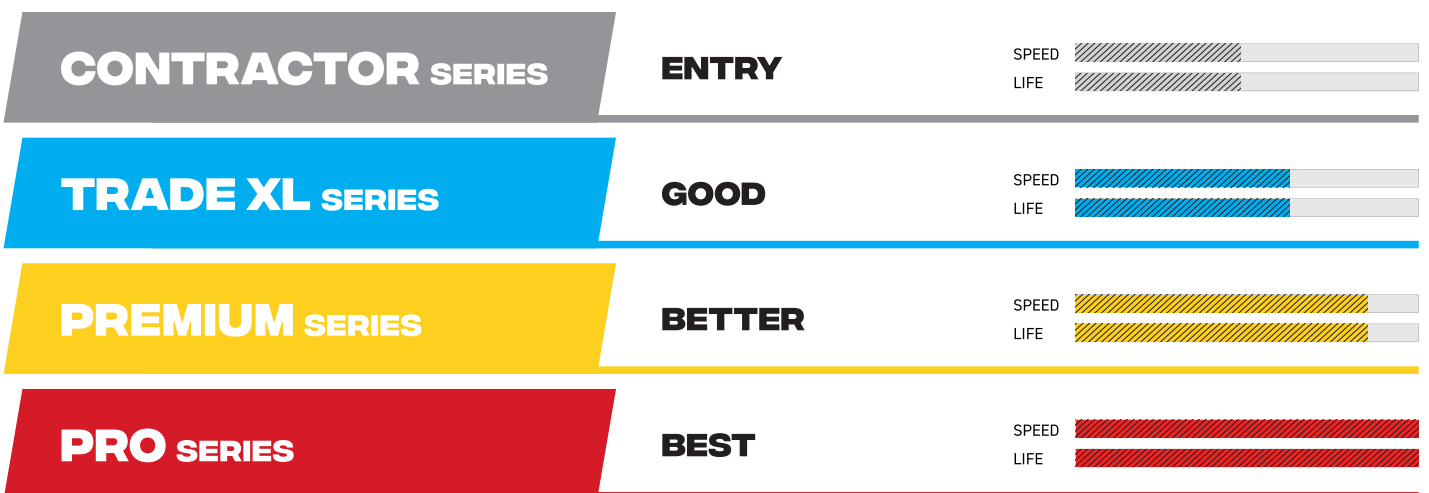

Refer page 193 - 197 for the Diamond Trouble Shooting Guide



MATERIAL CLASSES

MULTI PURPOSE

Hard materials & metal
Fast cutting universal
CUTS ALL CONSTRUCTION MATERIALS

GENERAL PURPOSE

Concrete & concrete products
General purpose
Un-abrasive products
Building products

COMBINATION

Abrasive materials
Concrete & asphalt
Dual purpose
Concrete products

ABRASIVE

Asphalt & extremely
abrasive products
Sandstone, limestone,
green concrete & asphalt

SERIES

CONTRACTOR

SEGMENTED

TURBO



CC10



CU10

TRADE XL



XL10



XLT

PREMIUM



TC10



TU10



TB10



TA10

PRO



MPS



PC10



PB10



PA10



MPSS



CONTRACTOR SERIES

The Contractor Series gives the benefit of a safe performing product for the cost conscious user.



CONTRACTOR CU10 - GENERAL PURPOSE

BLADE TYPE:
TURBO

PERFORMANCE:

SPEED

LIFE

APPLICATIONS:



REINFORCED
CONCRETE



BRICK



BLOCK

Product code	Barcode	Diameter (in)	Bore (mm)	RPM	Inner Qty	Outer Qty
OX-CU10-4	9341231054846	4	16	14500	5	50
OX-CU10-4.5	9341231054853	4 1/2	22.2/20	13200	5	50
OX-CU10-5	9341231054860	5	22.2/20	12200	5	50
OX-CU10-7	9341231054877	7	25.4/22.2	8600	5	50
OX-CU10-9	9341231054884	9	25.4/22.2	6600	5	50



CONTRACTOR CC10 - GENERAL PURPOSE

BLADE TYPE:
SEGMENTED

PERFORMANCE:

SPEED

LIFE

APPLICATIONS:



REINFORCED
CONCRETE



BRICK



BLOCK

Product code	Barcode	Diameter (in)	Bore (mm)	RPM	Inner Qty	Outer Qty
OX-CC10-4	9341231054907	4	16	14500	5	50
OX-CC10-4.5	9341231054914	4 1/2	22.2/20	13200	5	50
OX-CC10-5	9341231054921	5	22.2/20	12200	5	50
OX-CC10-9	9341231054938	9	25.4/22.2	6600	5	50
OX-CC10-14	9341231054945	14	25.4/20	4300	5	50
OX-CC10-16	9341231054952	16	25.4/20	3800	5	50



TRADE XL SERIES

The OX Trade XL Series offers the perfect balance between quality and value for money. This range of diamond blades covers speed, long life and ultimate value for the everyday tradesperson.

TRADE XL XLT TURBO - GENERAL PURPOSE

BLADE TYPE:
TURBO

PERFORMANCE:



APPLICATIONS:

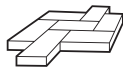

Product code	Barcode	Diameter (in)	Bore (mm)	RPM	Inner Qty	Outer Qty
OX-XLT-4	9341231054969	4	16	14500	5	50
OX-XLT-4.5	9341231054976	4 ½	22.2/20	13200	5	50
OX-XLT-5	9341231054983	5	22.2/20	12200	5	50
OX-XLT-7	9341231054990	7	25.4/22.2	8600	5	50
OX-XLT-9	9341231055003	9	25.4/22.2	6600	5	50

TRADE XL XL10 - GENERAL PURPOSE

BLADE TYPE:
SEGMENTED

PERFORMANCE:



APPLICATIONS:

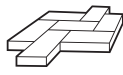

Product code	Barcode	Diameter (in)	Bore (mm)	RPM	Inner Qty	Outer Qty
OX-XL10-4	9341231055010	4	16	14500	10	100
OX-XL10-4.5	9341231055027	4 ½	22.2/20	13200	10	100
OX-XL10-5	9341231055034	5	22.2/20	12200	10	100
OX-XL10-9	9341231055041	9	25.4/22.2	6600	10	100
OX-XL10-14	9341231055058	14	25.4/20	4300	10	100
OX-XL10-16	9341231055065	16	25.4/20	3800	10	100



PREMIUM SERIES

The Premium Series allows blade users to get value for money without compromising on performance or safety. Not only are these the best blades available at this price level, they also provide a comprehensive range, offering the tradesperson a blade for every application.

PREMIUM TU10 - GENERAL PURPOSE



BLADE TYPE:
TURBO

PERFORMANCE:



APPLICATIONS:

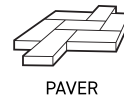

Product code	Barcode	Diameter (in)	Bore (mm)	RPM	Inner Qty	Outer Qty
OX-TU10-4	9341231002007	4	16	14500	10	100
OX-TU10-4.5	9341231002014	4 1/2	22.2/20	13200	10	100
OX-TU10-5	9341231002021	5	22.2/20	12000	10	100
OX-TU10-7	9341231002045	7	25.4/22.2	8500	10	50
OX-TU10-8	9341231002052	8	30/25.4	7600	10	50
OX-TU10-9	9341231002069	9	25.4/22.2	6600	10	30
OX-TU10-14	9341231002083	14	25.4/20	5400	5	10

PREMIUM TC10 - GENERAL PURPOSE



BLADE TYPE:
TURBO SEGMENTED

PERFORMANCE:



APPLICATIONS:

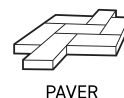

Product code	Barcode	Diameter (in)	Bore (mm)	RPM	Inner Qty	Outer Qty
OX-TC10-4	9341231002106	4	16	14500	0	60
OX-TC10-4.5	9341231002113	4 1/2	22.2/20	13200	0	50
OX-TC10-5	9341231002120	5	22.2/20	12000	0	50
OX-TC10-7	9341231002144	7	25.4/22.2	8500	0	50
OX-TC10-9	9341231002168	9	25.4/22.2	6600	0	25
OX-TC10-14	9341231002182	14	25.4/20	5400	0	10
OX-TC10-16	9341231020346	16	25.4/20	4800	0	10



PREMIUM SERIES

PREMIUM TB10 - COMBINATION

BLADE TYPE:
SEGMENTED

PERFORMANCE:



APPLICATIONS:



REINFORCED
CONCRETE



BRICK



GREEN
CONCRETE



SANDSTONE



Product code	Barcode	Diameter (in)	Bore (mm)	RPM	Inner Qty	Outer Qty
OX-TB10-4	9341231002205	4	16	14500	0	50
OX-TB10-5	9341231002229	5	22.2/20	12000	0	50
OX-TB10-7	9341231002243	7	25.4/22.2	8500	0	25
OX-TB10-8	9341231002250	8	30/25.4	7600	0	25
OX-TB10-9	9341231002267	9	25.4/22.2	6600	0	20
OX-TB10-14	9341231002281	14	25.4/20	5400	0	10
OX-TB10-16	9341231002298	16	25.4/20	4800	0	10

PREMIUM TA10 - ABRASIVE / ASPHALT SPECIALIST

BLADE TYPE:
SEGMENTED

PERFORMANCE:



APPLICATIONS:



GREEN
CONCRETE



ASPHALT



SANDSTONE



Product code	Barcode	Diameter (in)	Bore (mm)	RPM	Inner Qty	Outer Qty
OX-TA10-14	9341231002311	14	25.4/20	5400	0	10
OX-TA10-16	9341231055133	16	25.4/20	3800	0	10



PRO SERIES

The award winning, best selling PRO Series blades – including the MPS/MPSS Superior Blade – the best all round builders blade on the market. These are simply the best value for money blades available in this sector, giving performance you would associate with a professional product at a price that has revolutionised the market.

The Superior Blade...

CUTS ALL CONSTRUCTION MATERIALS



SUPERFAST TURBO segment technology combines aggressive cutting ability with a fine, clean cut and no burning of the segments. Eliminating the possibility of single segment detachment.



REINFORCED, EXTRA SECURE, DUAL CENTRE FLANGE AND UNIQUE COOL-FAST DESIGN for a quieter, cooler and safer blade, with no distortion in the cut.



In use, the blade is semi-transparent and cuts out much of the vibration associated with conventional diamond tools.



Safety and vibration tested to meet and surpass relevant standards. Conforms with EN13236.



CUTS EVERYTHING ON A CONSTRUCTION SITE!

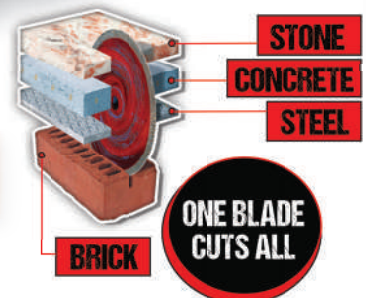



PRO SERIES

PRO SUPERIOR MPS - MULTI PURPOSE

BLADE TYPE:
TURBO

PERFORMANCE:



APPLICATIONS:



REINFORCED
CONCRETE



BRICK



BLOCK

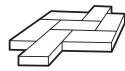

PAVER



GRANITE



**CUTS ALL
CONSTRUCTION MATERIALS**

Product code	Barcode	Diameter (in)	Bore (mm)	RPM	Inner Qty	Outer Qty
OX-04MPS	9341231002335	4	16	14500	10	100
OX-45MPS	9341231002342	4 1/2	22.2/20	13200	10	100
OX-05MPS	9341231002359	5	22.2/20	12000	10	100
OX-06MPS	9341231002366	6	25.4/20	10200	3	6
OX-07MPS	9341231002373	7	25.4/22.2	8500	5	10
OX-08MPS	9341231002380	8	30/25.4	7600	10	50
OX-09MPS	9341231002397	9	25.4/22.2	6600	10	30
OX-10MPS	9341231036279	10	25.4/20	6100	10	30
OX-14MPS	9341231002410	14	25.4/20	5400	5	10

PRO SUPERIOR MPSS SUPERFAST - MULTI PURPOSE

BLADE TYPE:
TURBO SEGMENTED

PERFORMANCE:



APPLICATIONS:



REINFORCED
CONCRETE



BRICK



BLOCK

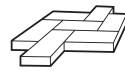

PAVER



GRANITE



**CUTS ALL
CONSTRUCTION MATERIALS**

Product code	Barcode	Diameter (in)	Bore (mm)	RPM	Inner Qty	Outer Qty
OX-12MPSS	9341231003172	12	25.4/20	5400	5	10
OX-14MPSS	9341231003189	14	25.4/20	4300	5	10
OX-16MPSS	9341231003196	16	25.4/20	3800	1	5



Angle Grinders & Demolition Saws

PRO SERIES

PRO PC10 - CONCRETE SPECIALIST



BLADE TYPE:
SEGMENTED

PERFORMANCE:



APPLICATIONS:

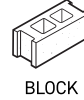

Product code	Barcode	Diameter (in)	Bore (mm)	RPM	Inner Qty	Outer Qty
OX-PC10-14	9341231055720	14	25.4/20	4300	1	5
OX-PC10-16	9341231055737	16	25.4/20	3800	1	5
OX-PC10-20	9341231018633	20	25.4/20	3050	1	5

PRO PB10 - COMBINATION



BLADE TYPE:
SEGMENTED

PERFORMANCE:



APPLICATIONS:



Product code	Barcode	Diameter (in)	Bore (mm)	RPM	Inner Qty	Outer Qty
OX-PB10-4	9341231002533	4	16	14500	6	24
OX-PB10-5	9341231002557	5	22.2/20	12000	6	24
OX-PB10-9	9341231002595	9	25.4/22.2	6600	6	24
OX-PB10-14	9341231002618	14	25.4/20	4300	5	10
OX-PB10-16	9341231012211	16	25.4/20	3800	5	10

PRO PA10 - ABRASIVE / GREEN CONCRETE



BLADE TYPE:
SEGMENTED

PERFORMANCE:



APPLICATIONS:



Product code	Barcode	Diameter (in)	Bore (mm)	RPM	Inner Qty	Outer Qty
OX-PA10-14	9341231002649	14	25.4/20	4300	5	10
OX-PA10-16	9341231002656	16	25.4/20	3800	5	10

Bricksaw & Blocksaw Blades



MATERIAL CLASSES

MULTI PURPOSE

Hard materials & metal
Fast cutting universal
CUTS ALL CONSTRUCTION MATERIALS

GENERAL PURPOSE

Concrete & concrete products
General purpose
Un-abrasive products
Building products

COMBINATION

Abrasive materials
Concrete & asphalt
Dual purpose
Concrete products

ABRASIVE

Asphalt & extremely
abrasive products
Sandstone, limestone,
green concrete & asphalt

SERIES

PRO



MPSS



PHB



PCB



PSB

SILENTYPE



PHBS
SILENTYPE



PCBS
SILENTYPE



PSBS
SILENTYPE

PRO SERIES

PRO MPSS SUPERFAST - MULTI PURPOSE

BLADE TYPE:
TURBO SEGMENTED

PERFORMANCE:



APPLICATIONS:



REINFORCED
CONCRETE



BRICK



BLOCK

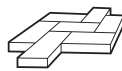

PAVER



GRANITE



CUTS ALL
CONSTRUCTION MATERIALS

Product code	Barcode	Diameter (in)	Bore (mm)	RPM	Inner Qty	Outer Qty
OX-12MPSS	9341231003172	12	25.4/20	5400	5	10
OX-14MPSS	9341231003189	14	25.4/20	4300	5	10
OX-16MPSS	9341231003196	16	25.4/20	3800	1	5



PRO SERIES

PRO PHB - HARD BRICK



BLADE TYPE:
SEGMENTED

PERFORMANCE:



APPLICATIONS:



HARD BRICK



BLOCK

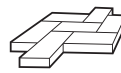

PAVER

Product code	Barcode	Diameter (in)	Bore (mm)	RPM	Inner Qty	Outer Qty
OX-PHB-14	9341231003233	14	25.4/20	4300	5	10

PRO PCB - 50 / 50 COMBINATION



BLADE TYPE:
SEGMENTED

PERFORMANCE:



APPLICATIONS:



50/50
CLAY/CONCRETE



CLAY
BRICKS

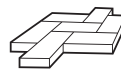

PAVER

Product code	Barcode	Diameter (in)	Bore (mm)	RPM	Inner Qty	Outer Qty
OX-PCB-14	9341231003264	14	25.4/20	4300	5	10

PRO PSB - SOFT BRICK



BLADE TYPE:
SEGMENTED

PERFORMANCE:



APPLICATIONS:



SOFT BRICK



BESSER
BLOCK

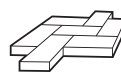

CONCRETE
PAVER

Product code	Barcode	Diameter (in)	Bore (mm)	RPM	Inner Qty	Outer Qty
OX-PSB-14	9341231003318	14	25.4/20	4300	1	5



PRO SERIES

PRO PHBS - HARD BRICK *SILENTYPE*

BLADE TYPE:
SEGMENTED

PERFORMANCE:



APPLICATIONS:



HARD BRICK



BLOCK

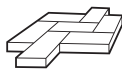

PAVER

Product code	Barcode	Diameter (in)	Bore (mm)	RPM	Inner Qty	Outer Qty
OX-PHBS-14	9341231003363	14	25.4/20	4300	1	5



PRO PCBS - 50 / 50 COMBINATION *SILENTYPE*

BLADE TYPE:
SEGMENTED

PERFORMANCE:



APPLICATIONS:



50/50
CLAY/CONCRETE



CLAY
BRICKS

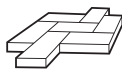

PAVER

Product code	Barcode	Diameter (in)	Bore (mm)	RPM	Inner Qty	Outer Qty
OX-PCBS-14	9341231003394	14	25.4/20	4300	1	5
OX-PCBS-16	9341231003400	16	25.4/20	3800	1	5
OX-PCBS-18	9341231003417	18	25.4/20	3350	1	5
OX-PCBS-20	9341231003424	20	25.4/20	3050	1	5



PRO PSBS - SOFT BRICK *SILENTYPE*

BLADE TYPE:
SEGMENTED

PERFORMANCE:



APPLICATIONS:



SOFT
BRICK



BESSER
BLOCK

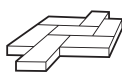

CONCRETE
PAVER

Product code	Barcode	Diameter (in)	Bore (mm)	RPM	Inner Qty	Outer Qty
OX-PSBS-14	9341231003448	14	25.4/20	4300	1	5
OX-PSBS-16	9341231003455	16	25.4/20	3800	1	5
OX-PSBS-20	9341231003479	20	25.4/20	3050	1	5





Ceramic & Stone Tiling Blades

MATERIAL CLASSES

TILING

Granite
Marble
Ceramic Tiles
Porcelain

SERIES

TRADE XL



XLCT

PRO



PCT



PCFT



2CM

TRADE XL SERIES

TRADE XL - XLCT CONTINUOUS - CERAMIC TILES



BLADE TYPE:
CONTINUOUS

APPLICATIONS:



CERAMIC
TILES

PERFORMANCE:



Product code	Barcode	Diameter (in)	Bore (mm)	RPM	Inner Qty	Outer Qty
OX-XLCT-4	9341231051814	4	16	14500	1	5
OX-XLCT-4.5	9341231054228	4 1/2	22.2/20	13200	1	5
OX-XLCT-5	9341231051821	5	22.2/20	12200	1	5



PRO SERIES

PRO PCT CONTINUOUS - ALL TILES

BLADE TYPE:
CONTINUOUS

PERFORMANCE:

SPEED

LIFE

APPLICATIONS:



GRANITE

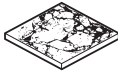

MARBLE



CERAMIC
TILES



PORCELAIN



Product code	Barcode	Diameter (in)	Bore (mm)	RPM	Inner Qty	Outer Qty
OX-PCT-4	9341231004179	4	16	14500	5	25
OX-PCT-4.5	9341231004186	4 ½	22.2/20	13200	5	25
OX-PCT-5	9341231004193	5	22.2/20	12200	5	25
OX-PCT-6	9341231004209	6	25.4/22.2	10000	5	25
OX-PCT-7	9341231004216	7	25.4/22.2	8600	5	25
OX-PCT-8	9341231004223	8	30/25.4	7600	5	25
OX-PCT-9	9341231004230	9	25.4/20	6600	5	25
OX-PCT-14	9341231004261	14	30/25.4	4300	5	25

PRO PCFT FINE TURBO - TILES

BLADE TYPE:
FINE TURBO

PERFORMANCE:

SPEED

LIFE

APPLICATIONS:



GRANITE



MARBLE



CERAMIC
TILES

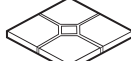

PORCELAIN



Product code	Barcode	Diameter (in)	Bore (mm)	RPM	Inner Qty	Outer Qty
OX-PCFT-4	9341231054310	4	16	14500	1	5
OX-PCFT-4.5	9341231054327	4 ½	22.2/20	13200	1	5
OX-PCFT-5	9341231054334	5	22.2/20	12200	1	5



Porcelain Diamond Blade

PRO SERIES



Reinforced flange for providing stable & accurate cuts

Suitable for wet and dry cutting

Mesh segment design



OX photo quality UV print ensures ultimate visibility on shelf and a clear overview of blade usage

Ideal for 20mm porcelain tiles and pavers

Cooling holes for fast effective heat reduction

PRO 2CM - PORCELAIN



BLADE TYPE:
FINE TURBO

PERFORMANCE:



APPLICATIONS:



CERAMIC TILES



PORCELAIN

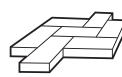

PAVER

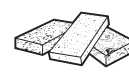

GRANITE

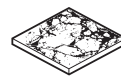

MARBLE

Product code	Barcode	Diameter (in)	Bore (mm)	RPM	Inner Qty	Outer Qty
OX-2CM-105/16	5060530357628	4"	105mm	14500	40	160
OX-2CM-115/22.2/20	5060530356973	4.5"	115mm	13200	40	160
OX-2CM-125/22.2/20	5060530356980	5"	125mm	12200	40	160
OX-2CM-180/25.4/22.2	5060530356997	7"	180mm	8600	12	60
OX-2CM-200/30/25.4	5060530357000	8"	200mm	7600	10	30
OX-2CM-230/22	5060530357017	9"	230mm	6600	10	30
OX-2CM-250/30/25.4	5060530357024	10"	250mm	6100	10	30
OX-2CM-300/30/25.4	5060530357031	12"	300mm	5100	1	10
OX-2CM-350/30/25.4	5060530357048	14"	350mm	4300	1	10

Specialist Blades



MATERIAL CLASSES

EARLY ENTRY

For extremely abrasive applications specialising in green concrete. For cutting concrete before it is cured

HARD MATERIALS

Fast and smooth cutting on granite, hard brick, reinforced concrete and other hard materials

SERIES

PREMIUM



TCF

PRO



PSCND



PSCSD

PREMIUM SERIES

PREMIUM TCF - FLUSH CUT

BLADE TYPE:
TURBO

PERFORMANCE:



APPLICATIONS:



REINFORCED
CONCRETE



HARD
BRICK

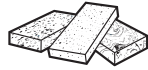

GRANITE



SANDSTONE



Product code	Barcode	Diameter (in)	Bore (mm)	RPM	Inner Qty	Outer Qty
OX-TFC-5	9341231054563	5"	M14 Flange	12,250	5	40



PRO SERIES

PRO PSCSD SOFT CUT - SAME DAY



BLADE TYPE:
SEGMENTED

APPLICATIONS:



GREEN
CONCRETE

PERFORMANCE:



Product code	Barcode	Diameter (in)	Bore (mm)	RPM	Inner Qty	Outer Qty
OX-PSCSD-6	9341231054181	6	Triangular Bore	12250	1	5

PRO PSCND SOFT CUT - NEXT DAY



BLADE TYPE:
SEGMENTED

APPLICATIONS:



GREEN
CONCRETE

PERFORMANCE:



Product code	Barcode	Diameter (in)	Bore (mm)	RPM	Inner Qty	Outer Qty
OX-PSCND-6	9341231054198	6	Triangular Bore	12250	1	5

Diamond Cup Wheels



MATERIAL CLASSES

GENERAL MASONRY PRODUCTS

Concrete, stone, clay bricks, paver, and general masonry products

TURBO

DOUBLE ROW

SPIRAL

SERIES

PRO

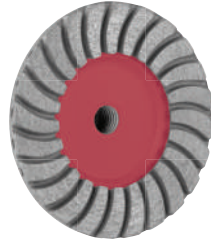

PCT

ULTIMATE



UCG

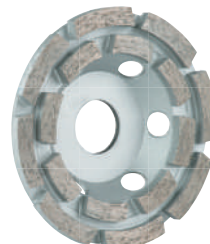

UCD



UCRB

PRO SERIES

Precision manufactured diamond grinding cups and heads for angle grinders and concrete planers. Available in either 14mm thread or a 22.2mm bush.

PRO PCT TURBO CUP WHEEL

Great for shaping and grinding of cured concrete, stone, clay bricks, pavers and general masonry products. These grinding cups have a double layer of diamond for longer life and better cooling.



Product code	Barcode	Diameter (in)	Bore (mm)	Grit	Inner Qty	Outer Qty
OX-PCTT-4	9341231004865	4	M14	30	3	6
OX-PCTB-4	9341231004872	4	22.2	30	3	6
OX-PCTB-5	9341231004896	5	22.2	30	3	6
OX-PCTT-7	9341231004902	7	M14	30	3	6
OX-PCTB-7	9341231004919	7	22.2	30	3	6



ULTIMATE SERIES

ULTIMATE UCDB DOUBLE ROW CUP WHEEL



High-performance cups have two rows of segments on the perimeter. Designed for aggressive removal of concrete bumps and imperfections with a longer life than single-row cups. (Not recommended for green concrete).

Product code	Barcode	Diameter (in)	Bore (mm)	Grit	Inner Qty	Outer Qty
OX-UCDB-4	9341231004933	4	22.2	30	1	20
OX-UCDB-4.5	9341231004957	4 1/2	22.2	30	3	6
OX-UCDB-5	9341231004971	5	22.2	30	1	20
OX-UCDB-7	9341231005015	7	22.2	30	20	5

ULTIMATE UCRB RADIAL SEGMENT CUP WHEEL



New

High quality, fast stripping radial segment cups. Available with a various number of segments in radial patterns. Applications include fast stripping of concrete coatings such as epoxy, paint and glues. Can also be used for concrete removal and formwork cleaning.

Product code	Barcode	Diameter (in)	Bore (mm)	No of Segments	Inner Qty	Outer Qty
OX-UCRB-5/10	9341231016400	5	22.2	10	6	36
OX-UCRB-5/6	9341231016394	5	22.2	6	6	36
OX-UCRB-7/12	9341231016417	7	22.2	12	6	12



ULTIMATE SERIES

ULTIMATE UCG TURBO CUP WHEEL

Great for shaping and grinding of cured concrete, stone, clay bricks, pavers and general masonry products. These grinding cups have a double layer of diamond for longer life and better cooling.



FINE GRIT

Product code	Barcode	Diameter (in)	Bore (mm)	Grit	Inner Qty	Outer Qty
OX-UCGFB-4	9341231038082	4	22.2	120	3	6
OX-UCGFB-5	9341231038099	5	22.2	120	3	6
OX-UCGFT-7	9341231038136	7	M14	120	3	6

MEDIUM GRIT

Product code	Barcode	Diameter (in)	Bore (mm)	Grit	Inner Qty	Outer Qty
OX-UCGMB-5	9341231038150	5	22.2	60	3	6
OX-UCGMT-7	9341231038198	7	M14	60	3	6
OX-UCGMB-7	9341231038167	7	22.2	60	3	6

COARSE GRIT

Product code	Barcode	Diameter (in)	Bore (mm)	Grit	Inner Qty	Outer Qty
OX-UCGT-4	9341231005022	4	M14	30	3	6
OX-UCGB-4	9341231005039	4	22.2	30	3	6
OX-UCGT-5	9341231005060	5	M14	30	3	6
OX-UCGB-5	9341231005077	5	22.2	30	1	20
OX-UCGB-7	9341231005091	7	22.2	30	1	5



Diamond Core Drills

With a wealth of experience in all types of diamond core drilling, OX has the most complete range of products available in the market today.

NO.1 FOR DRY CORE DRILLING

OX: the home of dry core drills.

INDUSTRY BENCHMARK.
The most popular.

For drilling brick and block.



NO.1 FOR WET CORE DRILLING

The professional choice for the professional contractor. UWC wet concrete drills have been tested and proven in the most demanding aggregates around the world.

For drilling reinforced concrete.



NO.1 FOR TILE DRILLING

Tile Drilling revolution. Quite simply, exactly what the market has been asking for. Fast, easy to use, and completely trouble free.

For drilling porcelain, granite, hard natural stones and ceramics.



NO.1 FOR CORE DRILLING KITS

The perfect start to dry core drilling, our aluminium cases are sturdier, smarter and contain more accessories than the competition. Often copied, but never surpassed, these are the cores to be seen with – and use.





Diamond Core Drills



Rapid, clean cutting & long life.

PRO PDC DRY CORE DRILL

Universal dry diamond core drill in all popular plumbers sizes up to 127mm. Slotted barrel provides efficient dust clearance and ease of removing drilled core. For brick and blockwork. Applications include: medium and soft bricks, concrete blocks (lightweight and dense), abrasive concrete products. Occasional use in harder materials e.g. semi engineering bricks and clay products. Minimum drill size: 850W

Product code	Barcode	Diameter (mm)	Length (mm)	Back end	Inner Qty	Outer Qty
OX-PDC-028	9341231005183	28	150	½" BSP	3	6
OX-PDC-032	9341231005190	32	150	½" BSP	3	6
OX-PDC-042	9341231054068	42	150	½" BSP	3	6
OX-PDC-052	9341231005220	52	150	½" BSP	3	6
OX-PDC-067	9341231054075	67	150	½" BSP	2	4
OX-PDC-078	9341231005244	78	150	½" BSP	2	4
OX-PDC-102	9341231005268	102	150	½" BSP	2	4
OX-PDC-117	9341231005282	117	150	½" BSP	2	4
OX-PDC-127	9341231005299	127	150	½" BSP	2	4





Dry Core Drills

PRO PCC DRY CORE CASE



FEATURES

- Everything you need to get started with dry core drilling in a sturdy aluminium case
- Contains PDC cores – 38, 52, 65, 117, 127mm
- Contains HEX & SDS adapters and extensions

Product code	Barcode	Core Sizes (mm)	Inner Qty	Outer Qty
OX-PCC-5	9341231007309	38, 52, 65, 117, 127	1	2

ULTIMATE UCC HELIX DRY CORE CASE



FEATURES

- Everything you need to get started with dry core drilling in a sturdy aluminium case
- Contains UDCL LONG LIFE cores – 38, 52, 65, 117, 127mm
- Contains HEX & SDS adapters and extensions

Product code	Barcode	Core Sizes (mm)	Inner Qty	Outer Qty
OX-UCC-5	9341231036491	38, 52, 65, 117, 127	2	4



Dry Core Accessories

OX dry core accessories are manufactured from the highest grade steel to ensure that they can withstand the toughest use. Zinc plating enhances the visual appearance and protects against rust without leaving oil deposits. The most complete range of accessories to cover all machinery options and personal preferences.

ADAPTORS - BSP (M)

Product code	Barcode	Core Sizes (mm)	Inner Qty	Outer Qty
OX-JX01	9341231012518	HEX ADAPTOR ONLY	3	6
OX-JX31	9341231012525	HEX 10" LONG ADAPTOR	3	6
OX-JS01	5060135472696	SDS (PLUS) ADAPTOR ONLY	6	18
OX-JS25	9341231012549	SDS (PLUS) 10" LONG ADAPTOR	3	6
OX-JM01	5060135472382	SDS MAX ADAPTOR ONLY	3	6



PILOTS & DRIFTS

Product code	Barcode	Core Sizes (mm)	Inner Qty	Outer Qty
OX-JB09	9341231012648	1/2" GUIDE ROD 8-1/4"	3	6
OX-JB13	5060135472269	1/2" A TAPER DRILL 8-1/4"	3	6
OX-JB05	5060135472238	DRIFT KEY	1	6



EXTENSIONS

Product code	Barcode	Core Sizes (mm)	Inner Qty	Outer Qty
OX-JB25	9341231012709	1/2" BSP 10" HOLLOW EXTENSION	3	6



ADAPTOR PACKS

Product code	Barcode	Core Sizes (mm)	Inner Qty	Outer Qty
OX-JX03	5060135472771	HEX ADAPTOR PACK (JX01, JB09, JB05)	3	6
OX-JX03-13	5060135472788	HEX A TAPER DRILL ADAPTOR PACK (JX01, JB13, JB05)	3	6
OX-JS03	5060135472702	SDS ADAPTOR PACK (JS01, JB09, JB05)	3	6
OX-JS03-13	5060135472719	SDS A TAPER DRILL ADAPTOR PACK (JS01, JB13, JB05)	3	6
OX-JM03	5060135472399	SDS MAX ADAPTOR PACK (JM01, JB09, JB05)	3	6





Wet Core Drills

ULTIMATE JP WATER SWIVEL



Holesaw accessory options for accurate positioning and water cooling.

Product code	Barcode	Description	Inner Qty	Outer Qty
OX-JP35	9341231036194	1/2" BSP(F) - Straight Shank Water Swivel	5	25

ULTIMATE UWC 1-1/4" UNC WET CORE

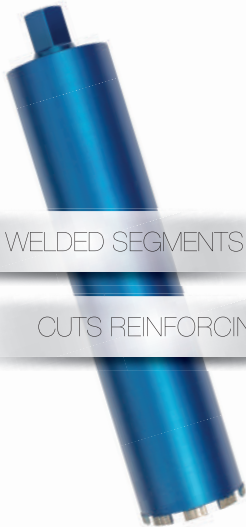

LASER WELDED SEGMENTS

CUTS REINFORCING

ULTIMATE wet diamond core drill for professional rig mounted use. 450mm drilling length. 10mm turbo segment height. Applications include: flint and limestone aggregate concrete; light to medium reinforced concrete; universal building products.

Product code	Barcode	Diameter (mm)	Length (mm)	Back end	3Inner Qty	Outer Qty
OX-UWC022-450	9341231005787	22	450	1 1/4" UNC	3	6
OX-UWC024-450	9341231001352	24	450	1 1/4" UNC	3	6
OX-UWC028-450	9341231005800	28	450	1 1/4" UNC	3	6
OX-UWC032-450	9341231005824	32	450	1 1/4" UNC	3	6
OX-UWC036-450	9341231005831	36	450	1 1/4" UNC	3	6
OX-UWC052-450	9341231005879	52	450	1 1/4" UNC	2	4
OX-UWC056-450	9341231005886	56	450	1 1/4" UNC	2	4
OX-UWC065-450	9341231005909	65	450	1 1/4" UNC	2	4
OX-UWC072-450	9341231005916	72	450	1 1/4" UNC	2	4
OX-UWC076-450	9341231005923	76	450	1 1/4" UNC	2	4
OX-UWC082-450	9341231005930	82	450	1 1/4" UNC	2	4
OX-UWC092-450	9341231005954	92	450	1 1/4" UNC	2	4
OX-UWC102-450	9341231005961	102	450	1 1/4" UNC	1	2
OX-UWC112-450	9341231005985	112	450	1 1/4" UNC	1	2
OX-UWC117-450	9341231005992	117	450	1 1/4" UNC	1	2
OX-UWC122-450	9341231006005	122	450	1 1/4" UNC	2	4
OX-UWC127-450	9341231006012	127	450	1 1/4" UNC	2	4
OX-UWC152-450	9341231006043	152	450	1 1/4" UNC	1	2
OX-UWC200-450	9341231006081	200	450	1 1/4" UNC	1	2

ULTIMATE WET CORE ACCESSORIES



Tough, durable adaptors and extensions for wet core drilling.

Product code	Barcode	Description	Inner Qty	Outer Qty
OX-JN55	9341231011771	1/2" BSP(M) - 1/2" BSP(M) ADAPTOR	3	6
OX-JN56	9341231011788	1/2" BSP(F) - 1/2" BSP(F) ADAPTOR	6	48
OX-JN65	9341231011795	1/2" BSP(M) - 1 1/4" UNC(M) ADAPTOR	3	6
OX-JN66	5060135472528	1/2" BSP(F) - 1 1/4" UNC(F) ADAPTOR	3	6
OX-JNHAD3	9341231011818	1/2" BSP(F) - HILTI DD100/130 ADAPTOR	3	6
OX-JN20	9341231011832	1 1/4" UNC 200mm HOLLOW EXTENSION	3	6
OX-JN30	9341231011849	1 1/4" UNC 300mm HOLLOW EXTENSION	3	6



Tile Drills

OX DIAMOND TILING HOLESAWS

FEATURES

- Designed to drill through any ceramic product with ease
- Drills: granite, marble, engineered stone, porcelain, ceramic tiles
- Wet & Dry Core



Product code	Barcode	Description	Inner Qty	Outer Qty
OX-TTDT-06	9341231051159	OX Diamond Tiling Holesaw M14 - 6mm	10	40
OX-TTDT-08	9341231051166	OX Diamond Tiling Holesaw M14 - 8mm	10	40
OX-TTDT-10	9341231051173	OX Diamond Tiling Holesaw M14 - 10mm	10	40
OX-TTDT-12	9341231051180	OX Diamond Tiling Holesaw M14 - 12mm	10	40
OX-UTDT-25	9341231006883	OX Diamond Tiling Holesaw M14 - 25mm	20	80
OX-UTDT-32	9341231016913	OX Diamond Tiling Holesaw M14 - 32mm	10	40
OX-UTDT-51	9341231051197	OX Diamond Tiling Holesaw M14 - 51mm	10	40

OX DIAMOND TILING HOLESAWS KIT

FEATURES

- Designed to drill through any ceramic product with ease
- Drills: granite, marble, engineered stone, porcelain, ceramic tiles
- Wet & Dry Core
- Sizes: 6mm, 8mm, 10mm, 12mm, 25mm, 36mm, 51mm & m14 - hex bit



Product code	Barcode	Description	Inner Qty	Outer Qty
OX-TTDT-10PC	9341231051142	OX Diamond Holesaw 10pc Kit	10	40

OX DIAMOND TILING HOLESAWS - ADAPTERS

Product code	Barcode	Core Sizes (mm)	Inner Qty	Outer Qty
OX-JX02	9341231051203	OX M14 Hex Drill Adapter	10	40
OX-JBA14	9341231051210	OX M10 - M14 Adapter - 2PC	10	40



OX-JX02

OX-JBA14



TRADE TTD DIAMOND HOLESAWS

Fast, fine cutting of marble, ceramics and stone. Low cost for the occasional user. Straight shank for use in 3 jaw chucks. Recommended for use with water feed.

Product code	Barcode	Diameter (mm)	Inner Qty	Outer Qty
OX-TTD-06	9341231006319	6	20	120
OX-TTD-20	9341231006364	20	15	90
OX-TTD-25	9341231006371	25	10	60
OX-TTD-30	9341231006395	30	10	60
OX-TTD-32	9341231006401	32	10	60
OX-TTD-36	9341231006418	36	5	60
OX-TTD-45	9341231006432	45	5	40
OX-TTD-51	9341231006449	51	5	20
OX-TTD-63	9341231006463	63	7	28



Concreting Tools

“The OX brand has been on our sites from day one when I started APS Contracting. Initially, it was the colour of the OX screeds that caught our attention, we loved that the blue matched our logo. Ten years on, our crews now use the full range of placing and finishing tools day in and day out. Concrete tools take a beating, and we need gear we can rely on. We also love how the range is constantly evolving and improving along the way. In our business, the finish really matters, and OX always performs.”

Aaron Simeon | APS Contracting





PRO ADJUSTABLE FORMWORK BRACKET

FEATURES

- Bracket is adjustable to suit 35mm to 50mm timber
- Used for forming 150mm brickwork rebate on house floor slabs

Product code	Barcode	Suits	Inner Qty	Outer Qty
OX-P101950	9341231021336	35 - 50mm	6	12



PRO FIXED FORMWORK BRACKET - 50MM

FEATURES

- Bracket suits 50mm timber
- Used for forming 150mm brickwork rebate on house floor slabs

Product code	Barcode	Suits	Inner Qty	Outer Qty
OX-P103405	9341231024320	2" / 50mm	6	24



TRADE TIE WIRE REEL

FEATURES

- Fits any standard belt
- Suits all types of tie wire
- Left or right hand use
- Cast aluminium construction

Product code	Barcode	Suits	Inner Qty	Outer Qty
OX-T299701	9341231020230	Fits any standard belt	4	24



TRADE TIE WIRE TWISTER - 310mm

FEATURES

- Soft grip
- Smooth operating spiral spindle
- Reinforcing ring to prevent unnecessary wear when hook end returns

Product code	Barcode	Size	Inner Qty	Outer Qty
OX-T230231	9341231020605	12" / 310mm	4	12





Concreting Tools

PRO TIE WIRE TWISTER - 310mm



FEATURES

- OXGRIP Handle
- Wear resistant bronze sleeve
- Leather re-coil 'stopper'
- Accurately machined spiral spindle

Product code	Barcode	Size	Inner Qty	Outer Qty
OX-P230231	9341231010705	12" / 310mm	5	30

ULTIMATE NARROW HEAD END CUTTING NIPPER



FEATURES

- Professional quality
- Individually hardened
- Drop forged from special tool steel
- PVC OXGRIP handles
- Max cut thickness 3.2mm / Hardness (Jaw) 61 HRC – OX-U230322
- Max cut thickness 3.5mm / Hardness (Jaw) 61 HRC – OX-U230325
- Max cut thickness 3.5mm / Hardness (Jaw) 61 HRC – OX-U230328

Product code	Barcode	Size	Inner Qty	Outer Qty
OX-U230322	9341231034916	8" / 220mm	6	36
OX-U230325	9341231034923	10" / 250mm	6	36
OX-U230328	9341231034930	11" / 280mm	6	36

ULTIMATE WIDE HEAD END CUTTING NIPPER



FEATURES

- Professional quality
- Individually hardened
- Drop forged from special tool steel
- PVC OXGRIP handles
- Max cut thickness 3.8mm / Hardness (Jaw) 60 HRC – OX-U230420

Product code	Barcode	Size	Inner Qty	Outer Qty
OX-U230420	9341231034954	8" / 200mm	1	6



PRO BOLT CUTTERS

FEATURES

- Heat treated alloy jaws - fully adjustable
- Rated to cut HRC40

Product code	Barcode	Size	Inner Qty	Outer Qty
OX-P230118	9341231021343	18" / 450mm	2	10
OX-P230124	9341231021350	24" / 600mm	2	8
OX-P230130	9341231021367	30" / 750mm	1	5
OX-P230136	9341231021374	36" / 900mm	1	3
OX-P230142	9341231021381	42" / 1050mm	1	3



PRO FORGED BOLT CUTTERS

FEATURES

- Fully Adjustable
- Alloy steel blade
- Drop forged handle
- Rated to cut HRC50

Product code	Barcode	Size	Inner Qty	Outer Qty
OX-P230530	9341231024351	30" / 750mm	2	4
OX-P230536	9341231024368	36" / 900mm	2	4



TRADE REBAR BENDER/CUTTER

FEATURES

- Jaws made of high carbon alloy tool steel - HRC54
- Cuts and bends grade 60 rebar
- Can be bolted to the floor
- Bends 90° and 180°
- Heavy duty
- Max cut 19mm Ø

Product code	Barcode	Size	Inner Qty	Outer Qty
OX-T230613	9341231000119	52" / 1320mm	2	6





Concreting Tools

TRADE CONCRETERS SHOVEL - HAMMERTONE

FEATURES

- Length: 1040mm
- 'D' grip handle
- Head size: 250mm x 300mm
- All steel, pressed and welded construction with a hammertone finish

Product code	Barcode	Size	Inner Qty	Outer Qty
OX-T281307	9341231016660	1040mm	4	12

TRADE LIGHTWEIGHT EXTRUSION RAKE

FEATURES

- 1500mm long handle with soft grip
- 45 degree edge angle
- Lightweight for ease of use
- Extruded rake plate

Product code	Barcode	Size	Inner Qty	Outer Qty
OX-T016301	9341231024443	100 x 500mm	4	24

PRO ALUMINIUM CONCRETE RAKE

FEATURES

- 1500mm long handle with soft grip
- 45 degree edge angle
- Braced for additional strength
- Aluminium construction - powder coated

Product code	Barcode	Size	Inner Qty	Outer Qty
OX-P016302	9341231024450	100 x 500mm	1	4



PRO ALUMINIUM CONCRETE RAKE – WITH HOOK

FEATURES

- 1500mm long handle with soft grip
- 45 degree edge angle
- Braced for additional strength
- With 8mm diameter hook for lifting rebar
- Powder coated handle

Product code	Barcode	Size	Inner Qty	Outer Qty
OX-P016303	9341231024467	100 x 500mm	1	4



PRO STRAIGHT EDGE

FEATURES

- High quality extruded aluminium
- Easy to clean powder-coated finish
- Fluted profile - easy to grip extrusion design

Product code	Barcode	Size (W x H x L)	Inner Qty	Outer Qty
OX-P021612	9341231000386	20 x 70 x 1200mm	1	4
OX-P021615	9341231000393	20 x 70 x 1500mm	1	4
OX-P021618	9341231000409	20 x 70 x 1800mm	1	4
OX-P021621	9341231000416	20 x 70 x 2100mm	1	4
OX-P021624	9341231000423	20 x 70 x 2400mm	1	4
OX-P021627	9341231000430	20 x 70 x 2700mm	1	4
OX-P021630	9341231000447	20 x 70 x 3000mm	1	4
OX-P021636	9341231000454	20 x 70 x 3600mm	1	4

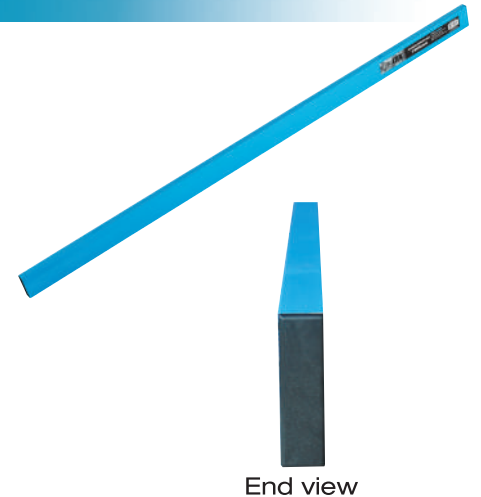

End view



Concreting Tools

PRO CLAMPED HANDLE SCREED

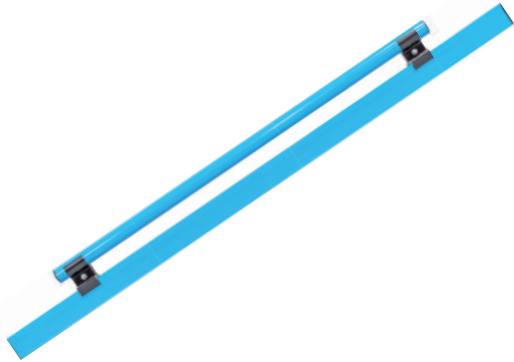

FEATURES

- Heavy duty structural alloy
- Reversible clamped handle
- Ergonomic grip handle
- Easy to clean powder-coated finish
- Internal strength support bars
- Cutting and pushing edge positioned for comfort
- Profile size 40 x 50mm

Product code	Barcode	Size	Inner Qty	Outer Qty
OX-P021408	9341231049811	800mm	1	4
OX-P021412	9341231000188	1200mm	1	4
OX-P021415	9341231000195	1500mm	1	4
OX-P021418	9341231000201	1800mm	1	4
OX-P021421	9341231000218	2100mm	1	4
OX-P021424	9341231000225	2400mm	1	4
OX-P021427	9341231000232	2700mm	1	4
OX-P021430	9341231000249	3000mm	1	4
OX-P021436	9341231000256	3600mm	1	4

PRO CLAMPED HANDLE SCREED WITH VIAL



FEATURES

- Built in vial for easy levelling
- Heavy duty structural alloy
- Reversible clamped handle
- Ergonomic grip handle
- Easy to clean powder-coated finish
- Internal strength support bars
- Cutting and pushing edge positioned for comfort
- Profile size 40 x 50mm



Product code	Barcode	Size	Inner Qty	Outer Qty
OX-P021312	9341231000973	1200mm	4	8
OX-P021315	9341231000980	1500mm	4	8
OX-P021318	9341231000997	1800mm	4	8
OX-P021321	9341231001000	2100mm	4	8
OX-P021324	9341231001017	2400mm	4	8
OX-P021327	9341231001024	2700mm	4	8
OX-P021330	9341231001031	3000mm	4	8
OX-P021336	9341231001048	3600mm	4	8



PRO ALUMINIUM BULLFLOAT

FEATURES

- Heavy duty structural alloy
- Easy to clean powder coated finish
- Extruded ribs for extra strength

Product code	Barcode	Size	Inner Qty	Outer Qty
OX-P016606	9341231000928	150 x 600mm	2	4
OX-P016609	9341231000935	150 x 900mm	2	4
OX-P016612	9341231000942	150 x 1200mm	2	4



PRO ALUMINIUM BULLFLOAT – MILLED FINISH

FEATURES

- Heavy duty structural alloy
- Mill finish for perfect finishing
- Extruded ribs for extra strength

Product code	Barcode	Size	Inner Qty	Outer Qty
OX-P016406	9341231024481	150 x 600mm	2	4
OX-P016409	9341231024498	150 x 900mm	2	4
OX-P016412	9341231024504	150 x 1200mm	2	4
OX-P016415	9341231024511	150 x 1500mm	2	4
OX-P016418	9341231024528	150 x 1800mm	2	4





Concreting Tools

PRO TELESCOPIC HANDLE



FEATURES

- Powder coated finish
- Fluted profile
- H.D.P.E screw-lock fitting
- "T" section "Twist Stop" extrusion design
- High quality extruded aluminium
- Comes with universal adaptor included

Product code	Barcode	Size	Inner Qty	Outer Qty
OX-P016524	9341231000829	1300 - 2400mm	1	4
OX-P016550	9341231000836	2700 - 5000mm	1	4

PRO TELESCOPIC HANDLE PARTS



FEATURES

- Suits OX-P016524 and OX-P016550

Product code	Barcode	Description	Inner Qty	Outer Qty
OX-P409901	9341231015854	Telescopic Handle Adaptor	5	20

PRO CLIP TOGETHER HANDLE

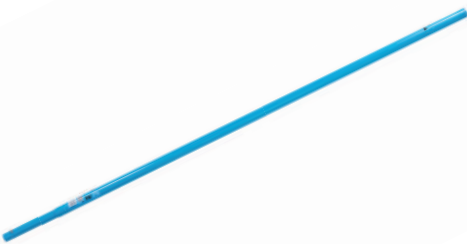

FEATURES

- High quality extruded aluminium
- Snap together for fast tool changes

Product code	Barcode	Size	Inner Qty	Outer Qty
OX-P019020	9341231024573	1800mm	1	4
OX-P019024	9341231025938	2400mm	1	4

PRO CLIP TOGETHER HANDLE ADAPTERS



FEATURES

- High quality extruded aluminium
- Available to suit all major manufacturers

Product code	Barcode	Description	Inner Qty	Outer Qty
OX-P019101	9341231024580	OX Male fitting	6	12
OX-P019102	9341231024597	OX Female fitting	6	12



PRO NARROW GROOVER

FEATURES

- High grade stainless steel blade
- Reversible OXGRIP handle
- Groove: Width 5/8" - 5/16" 15-8mm
Depth 3/8" 10mm (OX-P014210), 3/4" 19mm (OX-P014219)

Product code	Barcode	Size	Inner Qty	Outer Qty
OX-P014210	9341231011269	3 x 7" / 75 x 180mm	6	36
OX-P014219	9341231011276	3 x 7" / 75 x 180mm	6	24



PRO WIDE GROOVER

FEATURES

- High grade stainless steel blade
- Reversible OXGRIP handle
- Groove: Width 5/8" - 5/16" 15-8mm Depth 1/2" 12mm (OX-P014312), 25/32" 20mm (OX-P014320)

Product code	Barcode	Size	Inner Qty	Outer Qty
OX-P014312	9341231011283	6 x 7" / 155 x 180mm (12d)	4	16
OX-P014320	9341231011290	6 x 7" / 155 x 180mm (20d)	6	18



PRO GROOVER

FEATURES

- High grade stainless steel blade
- Reversible OXGRIP handle
- Groove: Width 3/16" 4.8mm Depth 3/8" 10mm

Product code	Barcode	Size	Inner Qty	Outer Qty
OX-P012510	9341231021428	3 1/2 x 6" / 90 x 150mm	6	24



TRADE NARROW EDGER

FEATURES

- Carbon steel blade
- One piece ergonomic plastic handle
- Blade size: 6 x 3" / 150 x 75mm

Product code	Barcode	Radius / Depth	Inner Qty	Outer Qty
OX-T016806	9341231010330	6mm, 12mm	6	48
OX-T016810	9341231010347	10mm, 19mm	6	48





Concreting Tools

PRO NARROW EDGER



FEATURES

- High grade stainless steel blade
- Rivetted handle support
- Reversible OXGRIP handle
- Blade size: 3 x 7" / 75 x 180mm

Product code	Barcode	Radius / Depth	Inner Qty	Outer Qty
OX-P014406	9341231011092	6mm, 12mm	6	36
OX-P014410	9341231011108	10mm, 19mm	4	32

TRADE MEDIUM EDGER



FEATURES

- Carbon steel blade
- One piece ergonomic plastic handle
- Blade size: OX-T016906 – 4 x 5" / 100 x 150mm
- Blade size: OX-T016910 – 4 x 5" / 100 x 150mm

Product code	Barcode	Radius / Depth	Inner Qty	Outer Qty
OX-T016906	9341231010361	6mm, 19mm	6	36
OX-T016910	9341231010378	10mm, 14mm	6	36

PRO MEDIUM EDGER



FEATURES

- High grade stainless steel blade
- Rivetted handle support
- Reversible OXGRIP handle
- Blade size: 4 x 7" / 100 x 180mm

Product code	Barcode	Radius / Depth	Inner Qty	Outer Qty
OX-P014506	9341231011115	6mm, 14mm	6	36
OX-P014510	9341231011122	10mm, 14mm	4	32
OX-P014519	9341231011139	19mm, 19mm	6	36

TRADE WIDE EDGER

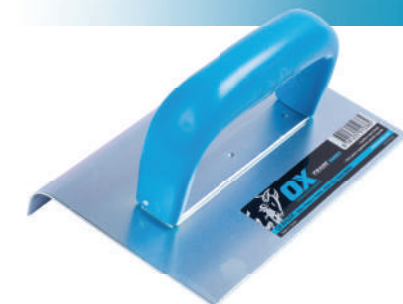

FEATURES

- Carbon steel blade
- One piece ergonomic plastic handle
- Blade size: OX-T017012 – 7 x 4¼" / 175 x 112mm

Product code	Barcode	Radius / Depth	Inner Qty	Outer Qty
OX-T017012	9341231010385	12mm, 22mm	6	36



PRO WIDE EDGER

FEATURES

- High grade stainless steel blade
- Rivetted handle support
- Reversible OXGRIP handle
- Blade size: 5 x 7½" / 130 x 190mm

Product code	Barcode	Radius / Depth	Inner Qty	Outer Qty
OX-P014812	9341231011146	12mm, 22mm	6	24
OX-P014820	9341231011153	20mm, 22mm	6	24
OX-P014825	9341231011160	25mm, 22mm	6	24



PRO EXTRA WIDE EDGER

FEATURES

- High grade stainless steel blade
- Rivetted handle support
- Reversible OXGRIP handle
- Blade size: 5¾ x 8½" / 145 x 215mm

Product code	Barcode	Radius / Depth	Inner Qty	Outer Qty
OX-P014910	9341231011306	10mm, 12mm	6	24
OX-P014912	9341231011177	12mm, 24mm	6	24
OX-P014916	9341231011313	16mm, 16mm	4	16
OX-P014925	9341231011184	25mm, 24mm	6	24



PRO STEP EDGER

FEATURES

- High grade stainless steel blade
- Rivetted handle support
- Reversible OXGRIP handle
- Blade size: 4 x 7" / 100 x 180mm

Product code	Barcode	Radius / Depth	Inner Qty	Outer Qty
OX-P015110	9341231011191	10mm, 50mm	6	24



PRO SAFETY STEP EDGER

FEATURES

- High grade stainless steel blade
- Reversible OXGRIP handle - rivetted handle support
- Cuts 4 grooves while edging the step
- Blade size: 5x7" / 120 x 180mm

Product code	Barcode	Radius / Depth	Inner Qty	Outer Qty
OX-P019312	9341231024689	10mm, 50mm	6	24





Concreting Tools

PRO COVING TROWEL



FEATURES

- High grade stainless steel blade
- Reversible OXGRIP handle - rivetted handle support
- Blade size: 4 x 7" / 100 x 180mm

Product code	Barcode	Radius / Depth	Inner Qty	Outer Qty
OX-P015010	9341231021435	4 x 7" / 100 x 180mm	6	24

PRO TIMBER FLOAT



FEATURES

- OXGRIP 'High lift' handle design
- High quality hardwood blade
- Special timber screws to prevent 'backing out'

Product code	Barcode	Size	Inner Qty	Outer Qty
OX-P012212	9341231013034	4½ x 12" / 112 x 300mm	4	16
OX-P012215	9341231013461	4½ x 15" / 112 x 380mm	4	16
OX-P012218	9328217006976	4½ x 18" / 112 x 450mm	6	24
OX-P012318	9341231020322	2½ x 18" / 50 x 450mm	6	36
OX-P012324	9328217006990	2½ x 24" / 65 x 600mm	6	24

PRO SPINNER FLOAT



FEATURES

- High grade stainless steel blade - 'dished design'
- Reversible OXGRIP handle

Product code	Barcode	Size	Inner Qty	Outer Qty
OX-P014112	9341231021206	4¾ x 11½" / 120 x 290mm	4	24
OX-P014114	9341231021213	5¾ x 8" / 145 x 215mm	6	36



PRO ALL SIDES UP FLOAT

FEATURES

- High grade stainless steel blade - 'dished design'
- Reversible OXGRIP handle

Product code	Barcode	Size	Inner Qty	Outer Qty
OX-P013910	9341231020452	4 x 11½" / 100 x 290mm	6	18
OX-P013916	9341231020469	6¼ x 8¼" / 160 x 210mm	6	18



PRO ALL SIDES UP FLOAT

FEATURES

- High grade stainless steel blade - 'dished design'
- Reversible OXGRIP handle

Product code	Barcode	Size	Inner Qty	Outer Qty
OX-P013938	9341231020476	6 x 15" / 150 x 380mm	6	12



PRO MAGNESIUM FLOAT – OXGRIP HANDLE

FEATURES

- Heavy duty magnesium blade
- Bevelled ends and rounded corners
- Ergonomic DURAGRIP handle

Product code	Barcode	Size	Inner Qty	Outer Qty
OX-P017012	9341231024900	3 x 12" / 80 x 300mm	4	12
OX-P017016	9341231011030	3 x 16" / 80 x 400mm	4	12
OX-P017020	9341231011047	3 x 20" / 80 x 500mm	4	12





Concreting Tools

PRO MAGNESIUM FLOAT – ROUNDED ENDS



FEATURES

- Heavy duty magnesium blade
- Ergonomic OXGRIP handle
- Fully rounded ends helps prevent float marks

Product code	Barcode	Size	Inner Qty	Outer Qty
OX-P400416	9341231024917	3 x 8" / 80 x 400mm	4	12

PRO MAGNESIUM FLOAT – WIDE BLADE



FEATURES

- Heavy duty magnesium blade
- Ergonomic OXGRIP handle
- Wide blade wears longer

Product code	Barcode	Size	Inner Qty	Outer Qty
OX-P400517	9341231024924	3½ x 16" / 90 x 400mm	4	12

TRADE POINTED FINISHING TROWEL



FEATURES

- Carbon steel blade
- One piece ergonomic plastic handle

Product code	Barcode	Size	Inner Qty	Outer Qty
OX-T017309	9341231010446	4 x 14" / 100 x 335mm	4	32
OX-T017301	9341231010453	4½ x 14" / 120 x 356mm	6	24
OX-T017391	9341231010460	4½ x 16" / 115 x 405mm	4	24
OX-T017392	9341231010477	4½ x 17¾" / 115 x 450mm	6	24
OX-T017365	9341231010491	4½ x 24" / 115 x 600mm	-	-

PRO POINTED FINISHING TROWEL



FEATURES

- High grade stainless steel blade
- Heavy duty aluminium shank
- 'Double hung' OXGRIP handle
- Stainless steel rivets holds the blade, shank and handle together with unsurpassed strength

Product code	Barcode	Size	Inner Qty	Outer Qty
OX-P014609	9341231011214	4 x 14" / 100 x 355mm	4	24
OX-P014601	9341231011207	4¾ x 14" / 120 x 356mm	6	24
OX-P014691	9341231011238	4½ x 16" / 115 x 405mm	4	16
OX-P014692	9341231011245	4½ x 17¾" / 115 x 450mm	4	16
OX-P014693	9341231011252	4½ x 19½" / 115 x 500mm	4	16
OX-P014665	9341231011221	4½ x 24" / 115 x 600mm	6	24



PRO POOL TROWEL – FLEXIBLE

FEATURES

- Heavy duty aluminium shank
- 'Double hung' OXGRIP handle
- Stainless steel rivets holds the blade, shank and handle together with unsurpassed strength
- High grade stainless steel blade

Product code	Barcode	Size	Inner Qty	Outer Qty
OX-P015712	9341231013744	4 x 11¾" / 100 x 300mm	6	36
OX-P015714	9341231013751	4 x 14" / 100 x 356mm	6	36
OX-P015718	9341231013768	4 x 18" / 100 x 457mm	6	24



PRO POOL TROWEL – RIGID

FEATURES

- Heavy duty aluminium shank
- OXGRIP handle
- Stainless steel rivets holds the blade, shank and handle together with unsurpassed strength
- High grade stainless steel blade

Product code	Barcode	Size	Inner Qty	Outer Qty
OX-P015818	9341231013782	4½ x 17¾" / 110 x 450mm	6	24



PRO SQUARE FINISHING TROWEL

FEATURES

- Heavy duty aluminium shank
- Double hung' OXGRIP handle
- Stainless steel rivets holds the blade, shank and handle together with unsurpassed strength
- High grade stainless steel blade

Product code	Barcode	Size	Inner Qty	Outer Qty
OX-P014702	9341231013799	4¾ x 11" / 120 x 280mm	6	24
OX-P014773	9341231013805	4¾ x 14" / 120 x 356mm	6	24
OX-P014781	9341231013812	4½ x 16" / 115 x 405mm	6	24





Concreting Tools

PRO WIDE WALKING EDGER



FEATURES

- High grade stainless steel blade
- Rivetted handle support
- Complete with fixed walking bracket
- Blade size: 5½ x 6¼" / 140 x 160mm

Product code	Barcode	Radius / Depth	Inner Qty	Outer Qty
OX-P401310	9341231025051	10mm, 12mm	6	32
OX-P401316	9341231025068	16mm, 18mm	6	36
OX-P401320	9341231025075	20mm, 20mm	6	36

PRO NARROW WALKING GROOVER



FEATURES

- High grade stainless steel blade
- Complete with fixed walking bracket
- Groove: Width 5/8" - 5/16" 15-8mm
- Depth ¾" 19mm

Product code	Barcode	Size	Inner Qty	Outer Qty
OX-P401203	9341231025044	3 x 6 ¼" / 75 x 160mm	6	36

PRO WIDE WALKING GROOVER



FEATURES

- High grade stainless steel blade
- Complete with fixed walking bracket
- Groove: Width 5/8" - 5/16" 15-8mm
- Depth ¾" 19mm

Product code	Barcode	Size	Inner Qty	Outer Qty
OX-P401206	9341231025037	6 x 6" / 150 x 160mm	6	36

PRO WALKING FLOAT



FEATURES

- High grade stainless steel blade
- Complete with fixed standing bracket

Product code	Barcode	Size	Inner Qty	Outer Qty
OX-P401416	9341231025099	6¼ x 8¼" / 160 x 210mm	5	15
OX-P401438	9341231025105	6 x 15" / 150 x 380mm	5	10



PRO FIXED BRACKET WALKING TROWEL

FEATURES

- Complete with fixed bracket
- High grade stainless steel

Product code	Barcode	Size	Inner Qty	Outer Qty
OX-P402760	9341231034374	4 ¼ x 24" / 120 x 600mm	2	6
OX-P402790	9341231034381	4 ¼ x 36" / 120 x 900mm	2	6



PRO ROTATING BRACKET WALKING TROWEL

FEATURES

- Complete with Fresno Bracket
- High grade stainless steel

Product code	Barcode	Size	Inner Qty	Outer Qty
OX-P402860	9341231034398	4 ¼ x 24" / 120 x 600mm	2	8
OX-P402890	9341231034404	4 ¼ x 36" / 120 x 900mm	2	10



PRO TILT BRACKET WALKING TROWEL

FEATURES

- Complete with tilt bracket
- High grade stainless steel

Product code	Barcode	Size	Inner Qty	Outer Qty
OX-P402960	9341231034411	4 ¼ x 24" / 120 x 600mm	2	10
OX-P402990	9341231034428	4 ¼ x 36" / 120 x 900mm	2	10



PRO WALKING TROWEL STANDING BRACKET

FEATURES

- Zinc plated steel
- Fully adjustable
- 25mm Ø Fitting

Product code	Barcode	Inner Qty	Outer Qty
OX-P016203	9341231021589	6	36





PRO WALKING TROWEL MECHANISM



FEATURES

- Zinc plated steel
- Fully adjustable
- 25mm Ø Fitting

Product code	Barcode	Inner Qty	Outer Qty
OX-P016201	9341231021596	6	48
OX-P016202	9341231021602	6	60
OX-P016204	9341231021619	6	24

PRO 750MM H/D FLOOR SQUEEGEE HEAD



FEATURES HEAD ONLY

- Red neoprene - excellent resistance to salt acids, gasoline, fats, grease, etc.
- Rust resistant galvanised steel frame, etc.
- Splash guard and reinforced handle socket
- Parallel fitting: 25mm

Product code	Barcode	Size	Inner Qty	Outer Qty
OX-P250575	9341231013904	29½" x 750mm	2	10

PRO TRADITIONAL FLOOR SQUEEGEE



FEATURES

- Hard rubber blade & pre-galvanised steel frame
- Tapered fitting
- Fitting: 27-20mm

Product code	Barcode	Size	Inner Qty	Outer Qty
OX-P250691	9341231013911	36" / 910mm	2	6

PRO CONCRETE FINISHING BROOM

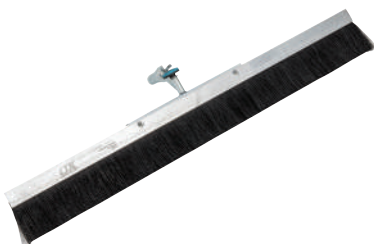

FEATURES

- Cast aluminium back
- Premium fibre bristles
- Complete with adaptor to suit telescopic handle

Product code	Barcode	Size	Inner Qty	Outer Qty
OX-P060390	9341231021497	36" / 900mm	2	10



PRO RUB BRICK

FEATURES

- Fluted silicone carbide
- Contoured one piece plastic handle
- New Rub Brick Size

Product code	Barcode	Size	Inner Qty	Outer Qty
OX-P071008	9341231025181	6"x3"x1" / 150x75x25mm	1	20



TRADE KNEELING BOARD

FEATURES

- One piece base - with built in extra grip handles
- One piece foam
- Firm foam for greater knee support

Product code	Barcode	Size	Inner Qty	Outer Qty
OX-T240300	9341231001284	350 x 480mm	1	10



PRO MANUAL BACKPACK SPRAYER - 15L

FEATURES

- Operating Pressure 0.2 - 0.4 Mpa (30-58 PSI)
- Viton Equipped Seals
- Comfortable Padded Shoulder Harness

Product code	Barcode	Size	Inner Qty	Outer Qty
OX-P044715	9341231038839	15L	4	12





Concreting Tools

PRO INDUSTRIAL CONCRETE SPRAYER - 13.2L

FEATURES

- Stainless steel heavy duty pump
- Stainless steel spray wand
- Stainless steel tank
- Flexible heavy duty chemical resistant hose
- Superior lock-on trigger assembly
- Ergonomic pump handle
- Genuine OXSeals equipped
- Wide mouth opening for easy filling & cleaning
- Holster for wand & nozzle storage



Product code	Barcode	Size	Inner Qty	Outer Qty
OX-P040713	9341231014413	13.2L	1	6





PRO CONCRETE SPRAYER REPLACEMENT PARTS LIST

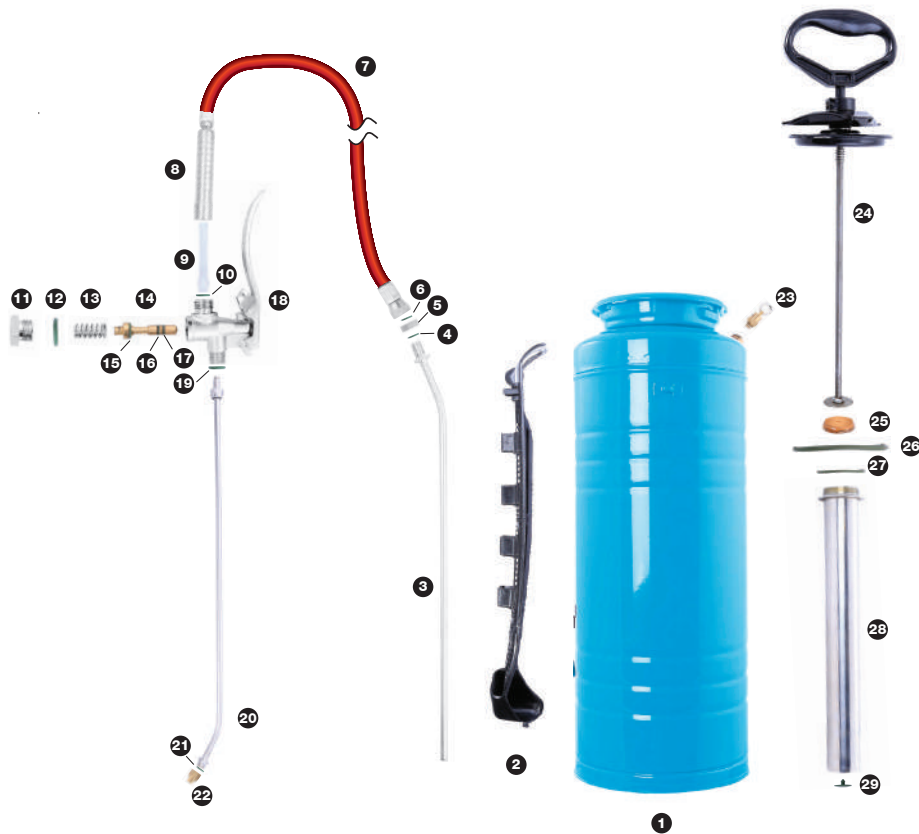

PARTS LIST

1. TANK
2. WAND HOLSTER
3. INLET TUBE
4. O RING SEAL
5. NUT
6. O RING SEAL
7. HOSE
8. END CAP
9. PLASTIC FILTER
10. O RING SEAL
11. END CAP
12. O RING SEAL
13. SPRING
14. SPINDLE
15. O RING SEAL
16. O RING SEAL
17. O RING SEAL
18. HANDLE HOUSING & TRIGGER
19. O RING SEAL
20. WAND
21. O RING SEAL
22. NOZZLE
23. RELIEF VALVE
24. PUMP HANDLE D PLUNGER
25. BRASS WASHER
26. WASHER
27. GASKET
28. BARREL
29. CHECK VALVE

Product code	Description	Parts Included
OX-P049301	OX Brass Fan Nozzle - 1.0 GPM (3.8LPM)	22
OX-P049302	OX 600mm Stainless Steel Spray Wand	19, 20 & 21
OX-P049303	OX Trigger Assembly	8, 9, 10, 11, 12, 13, 14, 15, 16, 17 & 18
OX-P049304	OX 1200mm Chemical Resistant Hose with Connections	6 & 7
OX-P049305	OX Genuine OXSeal and Gasket Kit	4, 6, 10, 12, 15, 16, 17, 19, 21, 25, 26, 27 & 29
OX-P049306	OX Stainless Steel Pump Assembly	24, 25, 26, 27, 28 & 28
OX-P049307	OX Plunger Assembly	24 & 25
OX-P049310	OX Supply Tube Assembly	3, 4 & 5



X-SERIES TROWEL MACHINE RANGE



Genuine Australian Certified Honda Motor

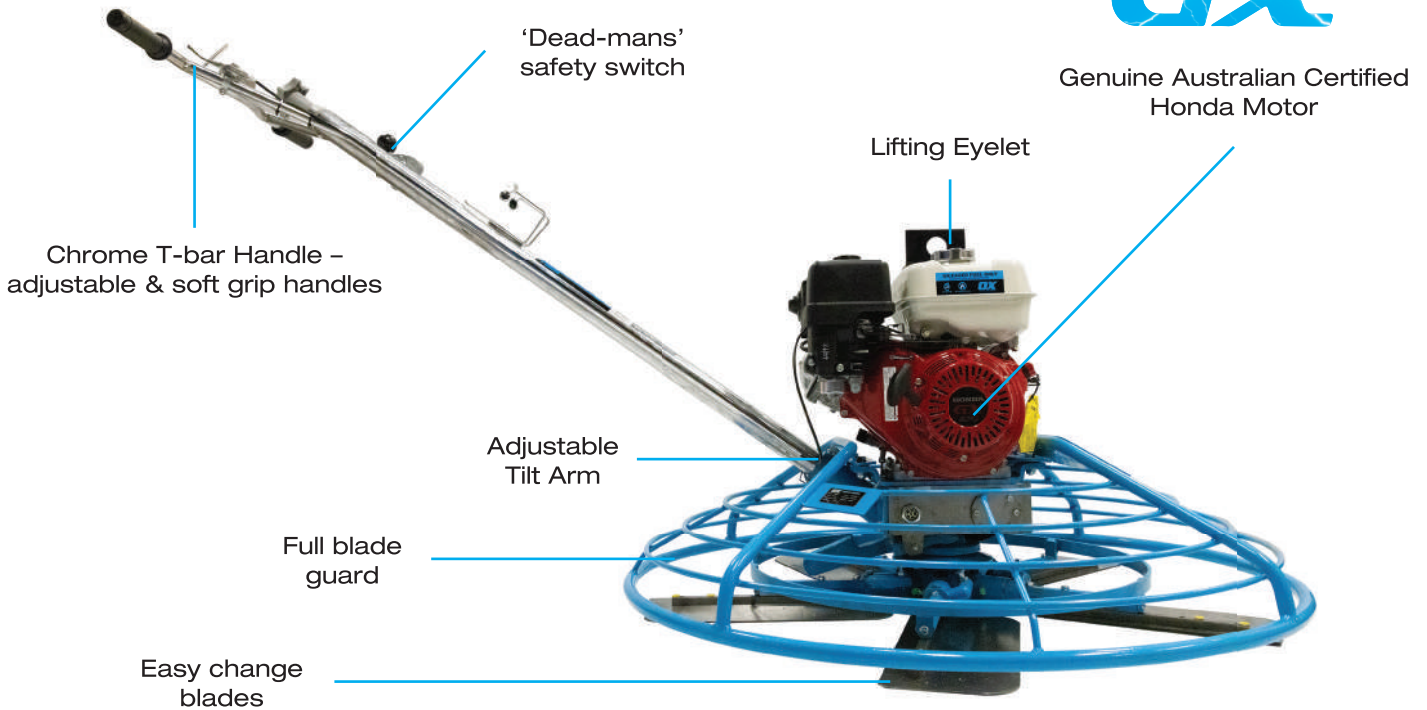

X-SERIES TROWEL MACHINE - 5 BLADES

1
YEAR WARRANTY

5
BLADES

FEATURES

- Powerful performance and easy handling
- Easy change stainless steel blades
- Chrome T-bar Handle - adjustable & soft grip handles
- 'Dead-mans' safety switch
- Full blade guard
- Protective engine cover included
- Genuine Australian Certified Honda Motor
- Manufacturer's 1 year warranty



Product code	Barcode	Honda Motor	Blade Size / Horse Power	Inner Qty	Outer Qty
OX-TM46/9	9341231042607	GX270	46" / 9HP	1	1
OX-TM46/13	9341231042614	GX390	46" / 13HP	1	1



POWERFUL PERFORMANCE



EASY CHANGE BLADES



CHROME T-BAR HANDLE

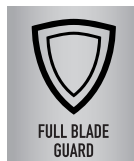

FULL BLADE GUARD



'DEAD-MANS' SAFETY SWITCH



PROTECTIVE ENGINE COVER INCLUDED



X-SERIES TROWEL MACHINE - 4 BLADES

FEATURES

- Powerful performance and easy handling
- Easy change stainless steel blades
- Chrome folding handle for ease of transportation and storage
- 'Dead-mans' safety switch
- Full blade guard
- Protective Engine Cover Included
- Genuine Australian Certified Honda Motor
- Manufacturer's 1 year warranty
- Rotating ring allows a smooth finish right up to walls and other structures

1
YEAR WARRANTY

4
BLADES



Product code	Barcode	Honda Motor	Blade Size / Horse Power	Inner Qty	Outer Qty
OX-TM24	9341231042546	GX160	24" / 5.5HP	1	1
OX-TM36	9341231042560	GX160	36" / 5.5HP	1	1
OX-TM36/9	9341231042584	GX270	36" / 9HP	1	1
OX-TM40	9341231042577	GX160	40" / 5.5HP	1	1
OX-TM40/9	9341231042591	GX270	40" / 9HP	1	1

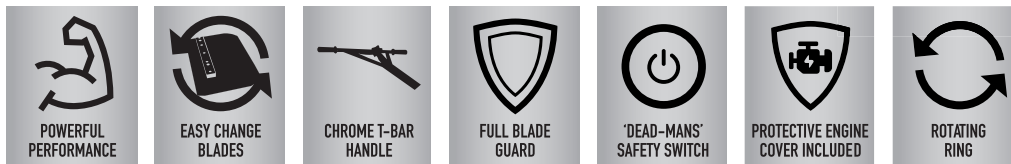

X-SERIES TROWEL MACHINE - 6 BLADES

FEATURES

- Powerful performance and easy handling
- Easy change stainless steel blades
- Chrome folding handle for ease of transportation and storage
- 'Dead-mans' safety switch
- Full blade guard
- Protective Engine Cover Included
- Genuine Australian Certified Honda Motor
- Manufacturer's 1 year warranty
- Rotating ring allows a smooth finish right up to walls and other structures

1
YEAR WARRANTY

6
BLADES



Product code	Barcode	Honda Motor	Blade Size / Horse Power	Inner Qty	Outer Qty
OX-TM30	9341231042935	GX160	30" / 5.5HP	1	1

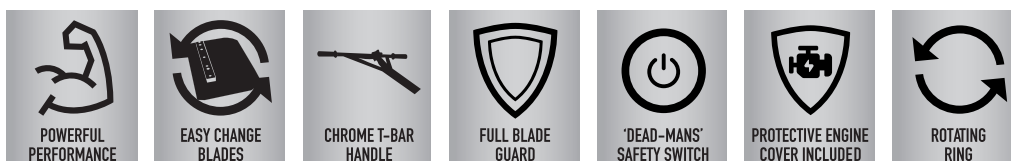



Concreting Tools

TRADE REPLACEMENT BLADES – STYLE 1 COMBINATION BLADE SET (4)



FEATURES

- Suitable for 34" machines
- 3/8" BSW threads
- Heat treated - for better wear
- Boxed for easy storage

Product Code	Barcode	No. of Threaded Holes	Size	Inner Qty	Outer Qty
OX-T181401	9341231000720	2	322x187mm	1	1

Suits: Master Finish 34" / Coates 34" / Cromellins 34" / Flextool 34"

TRADE REPLACEMENT BLADES – STYLE 2 COMBINATION BLADE SET (4)



FEATURES

- Suitable for 40" machines
- 3/8" BSW threads
- Heat treated - for better wear

Product Code	Barcode	No. of Threaded Holes	Size	Inner Qty	Outer Qty
OX-T181402	9341231000737	3	375x202mm	1	1

Suits: OX-TM40 & OX-TM40/9 / Master Finish 40" / Cromellins 40" / Flextool 40"

TRADE REPLACEMENT BLADES – STYLE 3 COMBINATION BLADE SET (4)

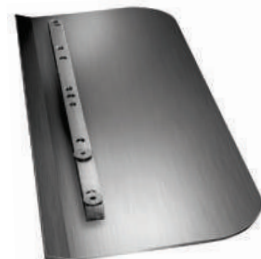

FEATURES

- Suitable for 46" & 48" machines
- 5/16" UNC threads
- 12 x replacement square head bolts included
- Heat treated - for better wear

Product Code	Barcode	No. of Threaded Holes	Size	Inner Qty	Outer Qty
OX-T181403	9341231000744	6	450x187mm	1	1

Suits: OX-TM46/9 & OX-TM46/13 / Master Finish 48" / Flextool 46" / Wackers 46" / Bartell 46"

TRADE REPLACEMENT BLADES – STYLE 4 COMBINATION BLADE SET (4)



FEATURES

- Suitable for 34" machines
- 16 x replacement square head bolts and locking nuts included
- Heat treated - for better wear

Product Code	Barcode	No. of Threaded Holes	Size	Inner Qty	Outer Qty
OX-T181404	9341231000751	3	322x187mm	1	1

Suits: Master Finish 34"

TRADE REPLACEMENT BLADES – STYLE 5 COMBINATION BLADE SET (4)



FEATURES

- Suitable for 40" machines
- 16 x replacement square head bolts and locking nuts included
- Heat treated - for better wear

Product Code	Barcode	No. of Threaded Holes	Size	Inner Qty	Outer Qty
OX-T181405	9341231000768	4	375x200mm	1	1

Suits: OX-TM40 & OX-TM40/9 / Master Finish 40"



TRADE REPLACEMENT BLADES – STYLE 6 COMBINATION BLADE SET (4)

FEATURES

- Suitable for 34" & 36" machines
- 5/16" UNC threads
- 8 x replacement bolts

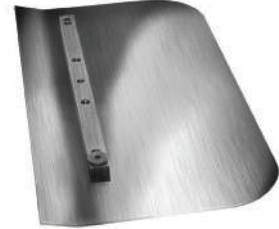

Product Code	Barcode	No. of Threaded Holes	Size	Inner Qty	Outer Qty
OX-T181406	9341231000775	3	355x187mm	1	1

Suits: OX-TM36 & OX-TM36/9 / Flextool 36" / Wackers 36" / Bartell 36" /Bartell 40"

TRADE REPLACEMENT BLADES – STYLE 7 FINISHING BLADE SET (4)

FEATURES

- Suitable for 46" & 48" machines
- Heat treated - for better wear
- 5/16" UNC threads



Product Code	Barcode	No. of Threaded Holes	Size	Inner Qty	Outer Qty
OX-T181407	9341231000782	6	455x152mm	1	1

Suits: OX-TM46/9 & OX-TM46/13 / Master Finish 48" / Flextool 46" / Wackers 46" / Bartell 46"

TRADE REPLACEMENT BLADES – STYLE 8 FINISHING BLADE SET (4)

FEATURES

- Suitable for 40" machines
- Heat treated - for better wear
- 3/8" BSW threads



Product Code	Barcode	No. of Threaded Holes	Size	Inner Qty	Outer Qty
OX-T181408	9341231000799	3	375x152mm	1	1

Suits: OX-TM40 / OX-TM40/9 / Master Finish 40" / Flextool 40" / Cromellins 40"

TRADE REPLACEMENT BLADES – STYLE 9 FINISHING BLADE SET (4)

FEATURES

- Suitable for 36" machines
- Heat treated - for better wear
- 5/16" UNC threads



Product Code	Barcode	No. of Threaded Holes	Size	Inner Qty	Outer Qty
OX-T181409	9341231000805	3	375x152mm	1	1

Suits: OX-TM36 & OX-TM36/9 / Flextool 36" / Wackers 36" / Bartell 36"

TRADE REPLACEMENT BLADES – STYLE 10 FINISHING BLADE SET (4)

FEATURES

- Suitable for 24" edging machines
- Heat treated - for better wear
- M16 threads



Product Code	Barcode	No. of Threaded Holes	Size	Inner Qty	Outer Qty
OX-T181410	9341231000812	2	230x120mm	1	1

Suits: OX-TM24

Bricklaying Tools

“Trowels being the most important tool in a bricklayers toolbox makes me choose OX bricklayers trowel range. I personally use the OX Philadelphia brick trowel. The handle is very comfortable and has a strong butt end. The blade is a mill or so thicker than most other brands which is very helpful when needing to trowel cut a brick, and ensures it holds its shape longer. It’s very well weighted and balanced. After years of using other brands, I have found the most comfort in this trowel.

From finishing joints to face bricks and blockwork is a detail that needs a lot of attention. My team and I use OX brickwork jointers to achieve the perfect finish. The Duragrip handle has to be the best handle for comfort and control.”

Peter Matolic | The Brick Co





Precision ground tapered blade

One Piece Fully Forged for Ultimate Strength

Fully Thermoplastic Rubber (TPR)

Perfectly Balanced Handle and Blade

Well balanced & perfect flexibility

Ergonomically Designed OXGRIP Handle

Indestructible End Cap for longer lasting wear



Bricklaying Tools

PRO POINTING TROWEL



FEATURES

- OXGRIP handle
- Welded shank
- Precision taper ground blade

Product code	Barcode	Size	Inner Qty	Outer Qty
OX-P013606	5060242330308	2¾" x 6" / 70 x 152mm	4	48

PRO GAUGING TROWEL



FEATURES

- Welded shank
- Precision taper ground blade
- OXGRIP handle
- 'S' style shank - will 'hang' on the side of a bucket

Product code	Barcode	Size	Inner Qty	Outer Qty
OX-P011407	5060242330261	3½ x 7" / 88 x 178mm	6	60

PRO BRICK TROWEL – PHILADELPHIA



FEATURES

- New Slimmer OXGRIP Handle for Greater Comfort
- Fully Thermoplastic Rubber (TPR)
- Indestructible End Cap for longer lasting wear
- Perfectly Balanced Handle and Blade
- Blade Forged, Heat Treated and Ground from One Piece of Steel
- Improved Weight Control & Balance
- New Shank Angle for Better Accuracy

Product code	Barcode	Size	Inner Qty	Outer Qty
OX-P011212	5060242330629	12" / 300mm	4	24

PRO BRICK TROWEL – LONDON



FEATURES

- New Slimmer OXGRIP Handle for Greater Comfort
- Fully Thermoplastic Rubber (TPR)
- Indestructible End Cap for longer lasting wear
- Perfectly Balanced Handle and Blade
- Blade Forged, Heat Treated and Ground from One Piece of Steel
- Improved Weight Control & Balance
- New Shank Angle for Better Accuracy

Product code	Barcode	Size	Inner Qty	Outer Qty
OX-P011112	9341231020445	12" / 300mm	4	24



PRO BRICK TROWEL - LONDON WITH DURAGRIP HANDLE

FEATURES

- Quality carbon steel blade
- OXGRIP handle
- Welded shank

Product code	Barcode	Size	Inner Qty	Outer Qty
OX-P010312	9341231022036	6 x 12" / 150 x 302mm	6	36



PRO STEEL BRICK JOINTER

FEATURES

- OXGRIP handle
- High quality bright steel

Product code	Barcode	Size	Inner Qty	Outer Qty
OX-P030312	9341231013263	495 x 12mm	4	24
OX-P030316	9341231013270	495 x 16mm	-	-



PRO MARGIN TROWEL

FEATURES

- High quality carbon steel
- Flat rectangular blade
- OXGRIP handle for extreme comfort
- Precision tapered ground blade

Product code	Barcode	Size	Inner Qty	Outer Qty
OX-P013416	9341231014321	2" x 6" / 50 x 150mm	4	12



PRO MORTAR SMOOTHING TOOL

FEATURES

- OXGRIP handle
- Bright steel finish
- One piece spring steel

Product code	Barcode	Size	Inner Qty	Outer Qty
OX-P011506	9341231013522	285 x 6mm	6	60
OX-P011508	9341231013249	285 x 8mm	6	60
OX-P011510	5060242330346	285 x 10mm	6	60



PRO SPOON JOINTER

FEATURES

- High quality carbon steel
- One piece spring steel

Product code	Barcode	Size	Inner Qty	Outer Qty
OX-P030813	9341231004834	3/8 & 1/2" / 10 & 13mm	4	72
OX-P030816	9341231011375	1/2 & 5/8" / 13 & 16mm	4	72





Bricklaying Tools

PRO FLEXIGLASS BRICK JOINTER



FEATURES

- OXGRIP handle
- One piece moulded acrylic
- Non stain acrylic for rolled joints
- Used for light coloured mortar - doesn't burn



Product code	Barcode	Size	Inner Qty	Outer Qty
OX-P030210	9341231022043	495 x 10mm	4	24
OX-P030212	9341231022050	495 x 12mm	4	24

PRO NON STAIN ROLL JOINTER



FEATURES

- Made from hardened acrylic material
- Will not mark or discolour white mortar
- 230mm in length
- Chamfered end

Product code	Barcode	Size	Inner Qty	Outer Qty
OX-P031209	9341231037580	25 x 230mm	5	35

PRO POLY WHEEL ROLLER RAKER



FEATURES

- OXGRIP handle
- Adjustable rake depth
- Zinc plated
- Steel frame

Product code	Barcode	Size	Inner Qty	Outer Qty
OX-P030501	9341231020285	220 x 93mm	6	36

PRO RUBBERISED PLASTIC LINE BLOCK - PAIR

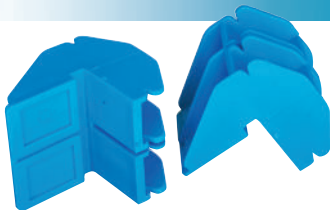

FEATURES

- One piece
- Rubberised OXGRIP

Product code	Barcode	Pack Qty	Size	Inner Qty	Outer Qty
OX-P101502	9341231001239	2	75 x 65 x 57mm	2	18

PRO RUBBER LINE BLOCK - 40PK

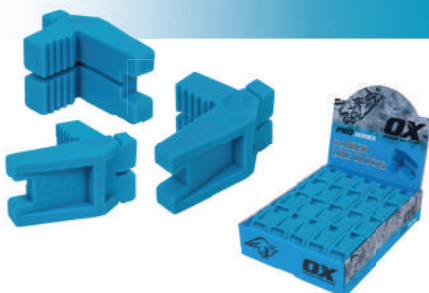

FEATURES

- High impact plastic
- High visibility blue colour

Product code	Barcode	Pack Qty	Size	Inner Qty	Outer Qty
OX-P101801-40	19341231001243	40	61 x 41 x 35mm	1	10



PRO BRICK CARRIER

FEATURES

- OXGRIP handle
- Adjustable
- Heavy duty construction
- Holds 5-6 bricks
- Lift Capacity 45kg



Product code	Barcode	Jaw Capacity	Inner Qty	Outer Qty
OX-P170350	9341231020254	400 - 500mm	4	12

PRO LIMESTONE BLOCK CARRIER

FEATURES

- Ergonomic Rubber Hand Grip
- Adjustable Spacings to Suit Different Block Sizes
- Lugs for Extra Grip



Product code	Barcode	Jaw Capacity	Inner Qty	Outer Qty
OX-P170701	9341231014635	500mm	1	4

PRO DUTCH PIN - SWIVEL (4 PACK)

FEATURES

- Semi-round swivel arm
- Solid forged and hardened
- Made from special high quality steel
- Galvanised



Product code	Barcode	Size	Inner Qty	Outer Qty
OX-P100715	9341231013621	100 x 150mm	4	16

PRO DUTCH PIN - FIXED (4 PACK)

FEATURES

- Semi-round fixed arm
- Solid forged and hardened
- Made from special high quality steel
- Galvanised



Product code	Barcode	Size	Inner Qty	Outer Qty
OX-P100615	9341231013614	100 x 150mm	4	16

PRO LINE PIN

FEATURES

- Made from solid forged carbon steel for ultimate strength
- Taper ground point & edges – drives easily into the wall
- Chrome plated for fine finish, extra wear resistance and rust prevention



Product code	Barcode	Pack Qty	Inner Qty	Outer Qty
OX-P100101	9341231013935	1	50	200



Bricklaying Tools

TRADE STRING LINE - 8 GAUGE



FEATURES

- Tough synthetic high tensile strength (42.8kg / 855 Tex)
- Ideal for brick and block laying
- Flexible plastic spool

Product code	Barcode	Colour / Size	Inner Qty	Outer Qty
OX-T102805	9341231013102	Fluro Lime / 50m	12	48
OX-T102810	9341231013119	Fluro Lime / 100m	12	48
OX-T102905	9341231013126	Fluro Pink / 50m	12	48
OX-T102910	9341231013133	Fluro Pink / 100m	12	48
OX-T103010	9341231013157	White / 100m	12	48

TRADE STRING LINE - 12 GAUGE



FEATURES

- Tough synthetic high tensile strength (66.5kg / 1345 Tex)
- Ideal for layout work, brick and block laying
- Flexible plastic spool

Product code	Barcode	Colour / Size	Inner Qty	Outer Qty
OX-T103210	9341231013294	Fluro Lime / 100m	12	48

TRADE STRING LINE - 12 GAUGE / 500M



FEATURES

- Tough synthetic high tensile strength (66.5kg / 1345 Tex)
- Ideal for layout work, brick and block laying
- Flexible plastic spool

Product code	Barcode	Colour / Size	Inner Qty	Outer Qty
OX-T103150	9341231054570	Fluro Lime / 500m	6	24



TRADE SCRUB BRUSH – TIMBER STOCK

FEATURES

- Quality smooth timber block
- Yellow crimped poly bristles



Product code	Barcode	Bristle Area	Inner Qty	Outer Qty
OX-T061001	9341231022449	65 x 190mm	6	24

TRADE BRICKIES BRUSH – DYED COCO FIBRE

FEATURES

- Quality smooth timber block
- Black dyed coco fibre bristles



Product code	Barcode	Bristle Area	Inner Qty	Outer Qty
OX-T060701	9341231022463	70 x 300mm	6	24

TRADE BRICKIES BRUSH – POLY FIBRE

FEATURES

- Quality smooth timber block
- Black poly fibre bristles



Product code	Barcode	Bristle Area	Inner Qty	Outer Qty
OX-T060601	9341231022456	70 x 300mm	6	24



Bricklaying Tools



PRO SLIDING PROFILE CLAMP

FEATURES

- Zinc plated solid steel
- 'T' bolt/thumb screw
- Thread length 80mm

Product code	Barcode	Size	Inner Qty	Outer Qty
OX-P101213	9341231021527	330mm	6	24
OX-P101222	9341231021534	560mm	6	18



PRO TOP STEADY NAIL-ON (VENEER) CLAMP SET

FEATURES

Bar & Clamp Set

- Zinc plated solid steel
- OXGRIP 'T' bolt/thumb screw
- New improved clamping system

Product code	Barcode	Description	Inner Qty	Outer Qty
OX-P101002	9341231021503	4 Piece Bar & Clamp Set	6	24



PRO TOP STEADY NAIL-ON (FULL BRICK) CLAMP SET

FEATURES

Bar & Clamp Set

- Zinc plated solid steel
- OXGRIP 'T' bolt/thumb screw
- New improved clamping system

Product code	Barcode	Description	Inner Qty	Outer Qty
OX-P101001	9341231022258	4 Piece Bar & Clamp Set	6	12



PRO TOP STEADY BAR

FEATURES

- Zinc plated
- Suits OX-P101001 or OX-P101002

Product code	Barcode	Size	Inner Qty	Outer Qty
OX-P101080	9341231021510	300 x 800mm	4	12



PRO 'T' PROFILE CLAMP

FEATURES

- Zinc plated solid steel
- OXGRIP 'T' bolt/thumb screw
- Thread length 80mm

Product code	Barcode	Size	Inner Qty	Outer Qty
OX-P101716	9341231022180	150mm	6	72



PRO PROFILE CLAMP

FEATURES

- Solid steel & zinc plated
- 'T' bolt thumb screw
- Thread length 80mm

Product code	Barcode	Size	Inner Qty	Outer Qty
OX-P100302	9341231013829	50mm	6	48
OX-P100307	9341231020216	180mm	6	36
OX-P100312	9341231020223	300mm	4	24



PRO HEAVY DUTY PROFILE POLE

FEATURES

- Durable galvanised steel
- Fine precise lines
- Reversible, two-sided markings
- Number of courses 33
- Professionally marked with the latest technology automatic machine

Product code	Barcode	Size	Inner Qty	Outer Qty
OX-P102432	9341231034060	2.83m	12	48



PRO PROFILE PROP

FEATURES

- Professional quality
- Steel heavy duty wing bolt
- High adjustable telescopic arm
- Galvanised steel construction
- Suits OX-P102432 (2 props per profile pole often used)

Product code	Barcode	Size	Inner Qty	Outer Qty
OX-P100501	9341231022289	2.83-3.50 meters	1	4



Plastering & Rendering Tools

“The whole rendering range from OX is incredible! We use various tools from the range every day. I have used many hand and power tools out there but they don't compare to OX. When you are doing the highest quality work you need the right tools for the job. The trowels, floats and sponges allow my team to meet the highest of standards on our high-end projects. My mixing drill hasn't missed a beat since I purchased it, mixing over 2 tons of render per week - a super reliable tool!”

Matt Jamieson | Render X



PRO SMALL TOOL

FEATURES

- Precision taper ground and tempered
- One piece solid drop forged from high quality carbon steel

Product code	Barcode	Width	Inner Qty	Outer Qty
OX-P010113	5060242330452	13mm	6	120
OX-P010116	5060242330469	16mm	6	120
OX-P010119	5060242330476	19mm	6	120
OX-P010125	5060242330483	25mm	6	120



TRADE JOINT KNIFE - STAINLESS STEEL

FEATURES

- Full Tang
- Stainless steel flexible blade
- Lanyard eyelet

Product Code	Barcode	Size	Inner Qty	Outer Qty
OX-T408403	9341231015656	32mm	12	144
OX-T408405	9341231015663	50mm	12	144
OX-T408407	9341231015670	75mm	12	144
OX-T408410	9341231015687	100mm	12	144
OX-T408412	9341231015694	125mm	12	144
OX-T408415	9341231015700	150mm	12	144
OX-T408425	9341231043079	250mm	12	144



PRO JOINT KNIFE

FEATURES

- Ergonomic OXGRIP handle
- High quality flexible stainless steel blade
- Full length tang-blade continues through handle to a built-in hammer end

Product code	Barcode	Square End Width	Inner Qty	Outer Qty
OX-P013203	5060242330438	32mm	4	12
OX-P013205	5060242330421	50mm	4	12
OX-P013207	5060242330414	76mm	12	144
OX-P013210	5060242330407	102mm	12	144
OX-P013212	5060242330391	127mm	4	12
OX-P013215	5060242330384	152mm	4	12





Plastering & Rendering Tools



PRO TAPING KNIFE

FEATURES

- Strong aluminium back
- Ergonomic OXGRIP handle
- High quality flexible stainless steel blade

Product code	Barcode	Square End Width	Inner Qty	Outer Qty
OX-P013320	9341231001192	200mm	12	72
OX-P013325	9341231010781	250mm	12	72
OX-P013330	9341231010798	300mm	12	72



PRO INTERNAL CORNER TROWEL

FEATURES

- OXGRIP handle
- Sturdy aluminium shank with strong mounting
- High quality stainless steel blade - will flex to form perfect 90° corners

Product code	Barcode	Size	Inner Qty	Outer Qty
OX-P013001	5060242330490	102 x 127mm	6	60



PRO SMALL INTERNAL CORNER TROWEL

FEATURES

- Sharp 90° Blade
- Ideal for finishing hard-wall plaster

Product code	Barcode	Size	Inner Qty	Outer Qty
OX-P408205	9341231015502	50 x 70mm	6	48



PRO EXTERNAL CORNER TROWEL - SMALL

FEATURES

- Stainless steel blade
- Ergonomic handle
- Blade angle 90° / blade radius 5r

Product code	Barcode	Blade Size	Inner Qty	Outer Qty
OX-P015305	9341231021251	26 x 65mm (radius 5r)	6	72



PRO EXTERNAL CORNER TROWEL - MEDIUM

FEATURES

- Stainless steel blade
- Ergonomic handle
- Blade angle 90° / blade radius 8r

Product code	Barcode	Blade Size	Inner Qty	Outer Qty
OX-P015408	9341231021268	40 x 65mm (radius 8r)	6	72



PRO EXTERNAL CORNER TROWEL - LARGE

FEATURES

- Stainless steel blade
- Ergonomic handle
- Blade angle 90° / blade radius 5r (OX-P015505)
- Blade angle 90° / blade radius 8r (OX-P015508)

Product code	Barcode	Size	Inner Qty	Outer Qty
OX-P015505	9341231021275	55 x 65mm (radius 5r)	6	48
OX-P015508	9341231021282	55 x 65mm (radius 8r)	6	48



TRADE FINISHING TROWEL – TIMBER HANDLE

FEATURES

- Carbon steel blade
- Aluminium shank
- Ergonomic timber handle

Product code	Barcode	Size	Inner Qty	Outer Qty
OX-T017211	9341231036323	115 x 280mm	6	24
OX-T017214	9341231022791	120 x 356mm	6	24





Plastering & Rendering Tools

TRADE FINISHING TROWEL – RUBBER HANDLE



FEATURES

- Carbon steel blade
- Aluminium shank
- Ergonomic rubber grip handle

Product code	Barcode	Size	Inner Qty	Outer Qty
OX-T010911	9341231022807	115 x 280mm	6	36
OX-T010914	9341231022814	120 x 356mm	4	24

PRO FINISHING TROWEL



CARBON STEEL

FEATURES

- High quality tempered steel blade
- Lightweight aluminium shank
- Handle position set for perfect balance
- Extended OXGRIP handle designed for increased comfort
- Fully riveted shank
- Cross ground blade - for reduced drag and quicker break-in time

Product code	Barcode	Size	Inner Qty	Outer Qty
OX-P010911	9341231021084	120 x 280mm	4	24
OX-P010914	5060242330582	120 x 356mm	6	24

PRO GOLDEN STEEL FINISHING TROWEL



FEATURES

- Pre-worn edges to eliminate line & ripple marks
- High quality tempered stainless steel blade
- Lightweight aluminium shank
- Handle set for perfect balance
- Fully riveted shank
- DURAGRIP handle for ultimate comfort

Product code	Barcode	Size	Inner Qty	Outer Qty
OX-P407311	9341231038822	114mm x 280mm	6	36
OX-P407314	9341231038280	127mm x 356mm	6	24

PRO ULTRAFLEX FINISHING TROWEL



FEATURES

- New ultra flexible trowel for a perfect finish
- Lightweight fully fastened shank for superior balance and strength
- Unique twin blade technology for ultimate flexibility
- 0.3mm Ultra flexible stainless steel blade
- Rounded corners to ensure a smooth finish
- Ergonomic soft grip handle

Product code	Barcode	Size	Inner Qty	Outer Qty
OX-P530111	5060359916310	11" / 280 x 110mm	1	6
OX-P530114	5060359916327	14" / 35x12x12	1	6



PRO RED TEXTURE FINISHING TROWEL

FEATURES

- Red PVC blade
- Ergonomic OXGRIP handle

Product code	Barcode	Size	Inner Qty	Outer Qty
OX-P408511	9341231015847	130 x 280mm	10	40



PRO SQUARE FRONT TROWEL

FEATURES

- OXGRIP handle with finger protection
- High quality carbon steel
- Heavy duty straight shank
- Soft grip handle for extreme comfort

Product code	Barcode	Size	Inner Qty	Outer Qty
OX-P013716	9341231051425	160mm	4	32
OX-P013718	5060242330506	180mm	4	32
OX-P013720	9341231022517	200mm	6	36



PRO RECTANGULAR PLASTIC FLOAT

FEATURES

- High strength ABS plastic
- Diamond patterned base

Product code	Barcode	Size	Inner Qty	Outer Qty
OX-P012127	9341231001796	180 x 270mm	2	18
OX-P012144	9341231022647	140 x 440mm	4	24
OX-P012135	9341231010767	270 x 350mm	2	14
OX-P012142	9341231022654	260 x 420mm	4	12



PRO POINTED PLASTIC FLOAT

FEATURES

- High strength ABS plastic
- Diamond patterned base

Product code	Barcode	Size	Inner Qty	Outer Qty
OX-P012027	9341231022630	140 x 270mm	4	12

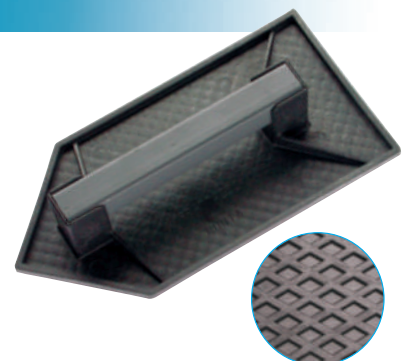



Plastering & Rendering Tools

TRADE POLYURETHANE FLOAT



FEATURES

- One piece moulded
- Lightweight

Product code	Barcode	Size	Inner Qty	Outer Qty
OX-T010214	9341231011924	140mm / 280mm	6	36
OX-T010218	9341231011931	180mm / 320mm	6	36

PRO RECTANGULAR POLYSTYRENE FLOAT



FEATURES

- High quality polystyrene
- One piece moulded

Product code	Barcode	Size	Inner Qty	Outer Qty
OX-P012814	9341231020308	140 x 260mm	4	12
OX-P012818	9341231020315	180 x 320mm	5	15

PRO BOAT SHAPED POLYSTYRENE FLOAT



FEATURES

- High quality polystyrene
- One piece moulded

Product code	Barcode	Size	Inner Qty	Outer Qty
OX-P012718	9341231020292	205 x 350mm	6	24

PRO RECTANGULAR POLYURETHANE FLOAT



FEATURES

- High quality polyurethane
- One piece moulded
- Made in the EU

Product code	Barcode	Size	Inner Qty	Outer Qty
OX-P010212	9341231001819	120 x 240mm	4	40
OX-P010214	9341231001826	140 x 280mm	4	40
OX-P010218	9341231001833	180 x 320mm	4	40
OX-P010220	9341231001840	200 x 360mm	4	24
OX-P010222	9341231001857	220 x 420mm	4	24



PRO ANGULAR POLYURETHANE FLOAT

FEATURES

- High quality polyurethane
- One piece moulded
- Made in the EU



Product code	Barcode	Size	Inner Qty	Outer Qty
OX-P010208	9341231001802	80 x 260mm	4	224

PRO PERFORATED SPONGE FLOAT

FEATURES

- Zinc plated perforated blade - easy to clean
- Special "fine cell" sponge
- OXGRIP handle



Product code	Barcode	Size	Inner Qty	Outer Qty
OX-P010830	9341231020339	130 x 300mm	6	24

- Replacement sponge
- Special sponge compound - designed for render
- 6 sponges per pack

Product code	Barcode	Size	Inner Qty	Outer Qty
OX-P019813	9341231022708	130 x 300mm	1	6

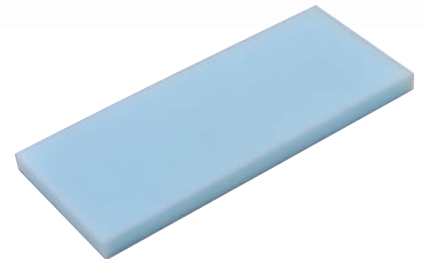

PRO YELLOW SPONGE FLOAT

FEATURES

- Ideal for sandy surfaces
- Fine cell foam pad specially bonded to an aluminium backing plate
- 1" thick foam sponge
- OXGRIP handle



Product code	Barcode	Size	Inner Qty	Outer Qty
OX-P402414	9341231032622	140 x 280mm	6	24

- Replacement sponge
- 6 sponges per pack

Product code	Barcode	Size	Inner Qty	Outer Qty
OX-P402514	9341231032639	140 x 280mm	6	12





Plastering & Rendering Tools

PRO PS RUBBER SPONGE FLOAT



FEATURES

- One piece moulded handle + blade
- Soft - Long life "sponge-rubber" material
- Made in the EU

Product code	Barcode	Size	Inner Qty	Outer Qty
OX-P014014	9341231010316	140 x 280mm	4	40

- Replacement sponge
- Pre-glued for convenience



Product code	Barcode	Size	Inner Qty	Outer Qty
OX-P019914	9341231001888	140 x 280mm	6	336

TRADE PLASTER HAWK

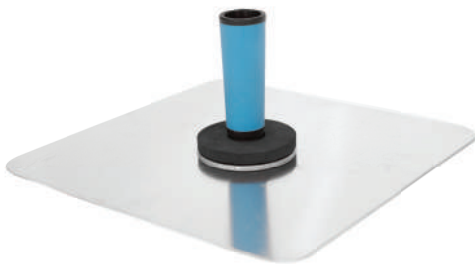

FEATURES

- Lightweight and tempered aluminium blade
- Sponge rubber callous preventer
- High quality duragrip handle

Product code	Barcode	Size	Inner Qty	Outer Qty
OX-T535213	9341231042973	330 x 330mm	4	12

PRO ALUMINIUM HAWK

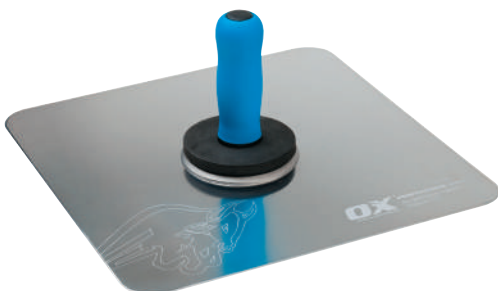

FEATURES

- OXGRIP handle
- High quality, lightweight and tempered aluminium blade mounted with 8 rivets for extra strength
- Machined Blade to prevent mortar from sliding off and aluminium from bowing or bending

Product code	Barcode	Size	Inner Qty	Outer Qty
OX-P010513	5060242330377	330 x 330mm	4	24



PRO MASONRY WATER BRUSH

FEATURES

- White tampico fibre bristles
- Bristles set securely into hardwood block
- Handle pinned and glued for secure attachment
- Round Handle
- Made in the U.S.A



Product code	Barcode	Bristles	Inner Qty	Outer Qty
OX-P060105	9341231013485	5 Rows	4	12

TRADE WATER BRUSH

FEATURES

- Quality smooth timber block
- White coco fibre bristles
- Two knot



Product code	Barcode	Bristle Area	Inner Qty	Outer Qty
OX-T060802	9341231011900	120 x 60 x 150mm	6	24

TRADE ACID BRUSH

FEATURES

- Quality smooth timber block
- White coco fibre bristles



Product code	Barcode	Bristle Area	Inner Qty	Outer Qty
OX-T060801	9341231022821	50mm	6	24



Plastering & Rendering Tools

PRO PLASTERER'S SQUARE



FEATURES

- Stainless steel
- Fully adjustable for precise bevels
- Adjustable wing nuts for setting desired internal and external angles

Product code	Barcode	Internal Size	Inner Qty	Outer Qty
OX-P020201	9341231022616	210 x 210 x 300mm	1	6

TRADE WEEPHOLE CLEANER



FEATURES

- Stainless steel
- Template for accurate weephole
- Bottle opener hole

Product code	Barcode	Size	Inner Qty	Outer Qty
OX-T030401	9341231001277	75 & 50mm	6	48

PRO PLASTER SCOOP



FEATURES

- OXGRIP handle
- Heavy duty galvanised pan - for longevity
- Bracket Bucket hang hook

Product code	Barcode	Size	Inner Qty	Outer Qty
OX-P010718	9341231011368	180mm	6	12



TRADE PLASTER SCOOP

FEATURES

- Economical plastic construction
- Sturdy grip to withstand heavy loads
- Lightweight

Product code	Barcode	Size	Inner Qty	Outer Qty
OX-T530217	9341231016028	180mm	1	30



TRADE TEXTURE GUN - SQUARE

FEATURES

- Ideal for applying masonry coatings - cement render, and concrete re-surfacing products
- With airflow regulator and 45° elbow
- Operating pressure bar 3.0-4.0
- Air volume usage 0.623 CBM / min

Product code	Barcode	Size	Inner Qty	Outer Qty
OX-T040308	9341231013607	8L	1	6



PRO SCORE & SNAP KNIFE

FEATURES

- All steel
- Chrome plated
- Double sided tungsten tipped

Product code	Barcode	Size	Inner Qty	Outer Qty
OX-P220102	9341231011764	220mm	12	96





Plastering & Dry Lining Tools

PRO SPEEDSKIM – ST (PLASTERING & RENDERING)

FEATURES

- Speedskim® is the new and revolutionary tool system designed to increase metreage output and enhance quality of finish – at the same time significantly reducing the harmful effects of fatigue & RSI
- Flattening, finishing & ruling off
- Compatible with all gypsum based plasters (hand and spray applied), Traditional sand & cement renders and insulated rendering systems
- Complete with integral blade guard



Product Code	Barcode	Size	Inner Qty	Outer Qty
OX-P530960	5060359919250	600mm	1	4
OX-P530990	5060359919267	900mm	1	4
OX-P530912	5060359919274	1200mm	1	4
OX-P530918	5060359919281	1800mm	1	4

Replacement blade

Product Code	Barcode	Size	Inner Qty	Outer Qty
OX-P531260	5060359919380	600mm	1	14
OX-P531290	5060359919540	900mm	1	14



PRO SPEEDSKIM – POLE ATTACHMENT

FEATURES

- Fully compatible with all standard professional 'threaded' extension poles
- Constructed from 'tough glass filled' nylon
- Compatible with all sizes of Speedskim



Product Code	Barcode	Inner Qty	Outer Qty
OX-P531501	5060359919502	1	32



PRO SPEEDSKIM – SF (FINE FINISHING & DRYWALL)

FEATURES

- Speedskim® is the new and revolutionary tool system designed to increase metreage output and enhance quality of finish – at the same time significantly reducing the harmful effects of fatigue & RSI
- Ultra-fine 0.3mm stainless steel blade
- Fine finishing of plaster, drywall & tape & jointing
- Compatible with all gypsum based finishing plasters (hand and spray applied), Jointing systems and compounds
- Complete with integral blade guard



Product Code	Barcode	Size	Inner Qty	Outer Qty
OX-P531060	5060359919311	600mm	1	14
OX-P531090	5060359919328	900mm	1	14
OX-P531012	5060359919335	1200mm	1	14

Replacement blade

Product Code	Barcode	Size	Inner Qty	Outer Qty
OX-P531345	5060359919434	450mm	1	14
OX-P531360	5060359919441	600mm	1	14
OX-P531390	5060359919458	900mm	1	14

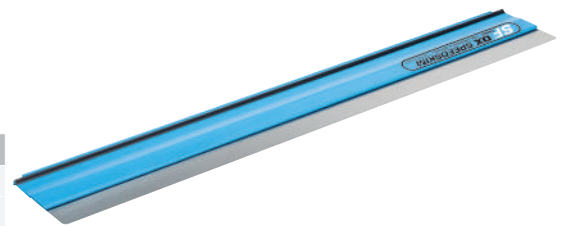

UK Professional Builder Magazine

Covered by world patents, registered designs & pending applications.



Plastering & Rendering Tools



TECHNICAL INFORMATION	
Input Power	1600W
No Load Speed Gear 1	180-400RPM
No Load Speed Gear 2	300-700RPM
Spindle	M14
Weight	6.5kg

PRO 1600W MIXING DRILL



FEATURES

- Powerful 1600w motor
- Ergonomically Balanced Design
- Variable Speed
- Lightweight 6kg
- Competitively priced
- 3 Pin Plug
- Bonus Mixing Paddle
- Bonus Extension



Product code	Barcode	Description	Inner Qty	Outer Qty
OX-P286	9341231018275	62x22x32	1	2



PRO MEGA WHIP MIXER (M14)

FEATURES

- Zinc plated
- Parallel mixing action
- Suitable for tile adhesives, grout, render, paint and mud

Product code	Barcode	Drive	Size mm	Inner Qty	Outer Qty
OX-P122701	9341231019524	M14	165 x 600mm	6	24



PRO MIXING PADDLE – RIBBON

FEATURES

- Chrome plated
- For mixing paint and general liquids
- Low to medium viscosity materials

Product code	Barcode	Drive HEX-mm (Male)	Batch Size kg	Size mm	Inner Qty	Outer Qty
OX-P120308	9341231010842	8	5 - 10	80 x 400	12	48

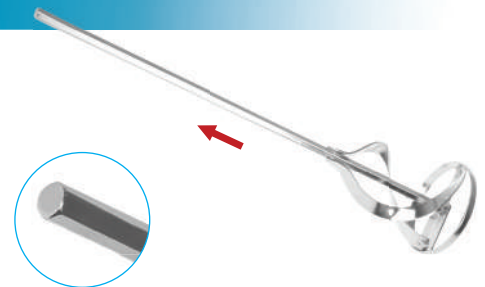

PRO MIXING PADDLE - DUAL FIN

FEATURES

- Chrome plated
- For mixing paint, tile glue, grout etc.
- Multi-purpose use on low to high viscosity materials

Product code	Barcode	Drive HEX-mm (Male)	Batch Size kg	Size mm	Inner Qty	Outer Qty
OX-P120809	9341231010927	8	5 - 15	85 x 500	12	36

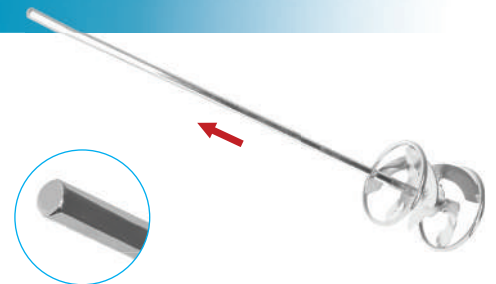

PRO MIXING PADDLE – HELICAL WITH RIM

FEATURES

- Chrome plated
- For mixing tile glue, grout etc.
- use on high viscosity materials

Product code	Barcode	Drive HEX-mm (Male)	Batch Size kg	Size mm	Inner Qty	Outer Qty
OX-P120609	9341231010897	8	5 - 15	90 x 500	12	48
OX-P120612	9341231010903	10	20 - -30	120 x 600	6	18

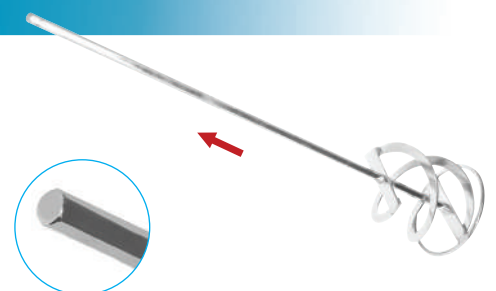



Plastering & Rendering Tools

PRO MIXING PADDLE – HELICAL WITH RIM

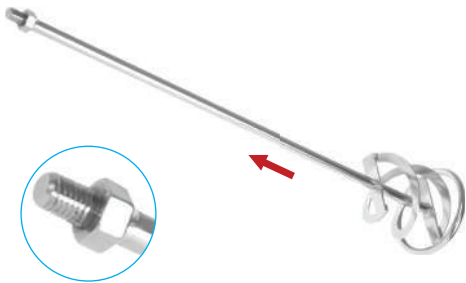

IDEAL FOR TILING

FEATURES

- Chrome plated
- For mixing tile glue, grout etc.
- use on high viscosity materials

Product code	Barcode	Drive	Batch Size kg	Size mm	Inner Qty	Outer Qty
OX-P121035	9341231010965	M14	50L	135 x 650	6	18

PRO MIXING PADDLE – POSITIVE HELIX

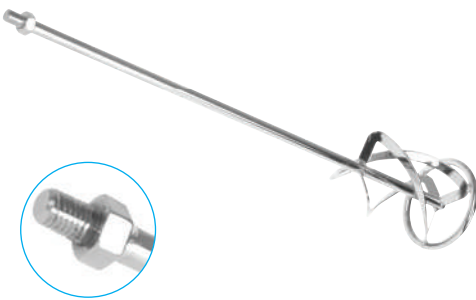

FEATURES

- Chrome plated
- For mixing acrylic render without grit, thick paint
- use on high viscosity materials

Product code	Barcode	Drive	Batch Size kg	Size mm	Inner Qty	Outer Qty
OX-P120535	9341231010880	M14	25 - 40	135 x 650	4	12

PRO MIXING PADDLE – NEGATIVE HELIX

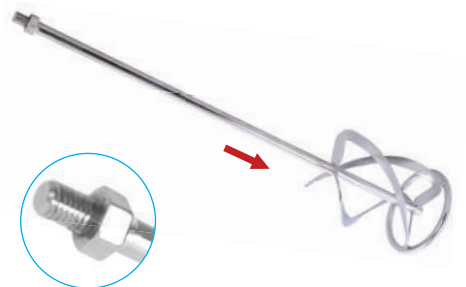

FEATURES

- Chrome plated
- For mixing acrylic render with grit, thick paint etc.
- use on medium viscosity materials

Product code	Barcode	Drive	Batch Size kg	Size mm	Inner Qty	Outer Qty
OX-P120435	9341231010866	M14	25 - 40	135 x 650	4	12



PRO HEAVY DUTY STIRRER

FEATURES

- Chrome plated
- For mixing lime putty plaster

Product code	Barcode	Drive	Batch Size kg	Size mm	Inner Qty	Outer Qty
OX-P120220	9341231010835	M14	55 - 70	200 x 650	4	12

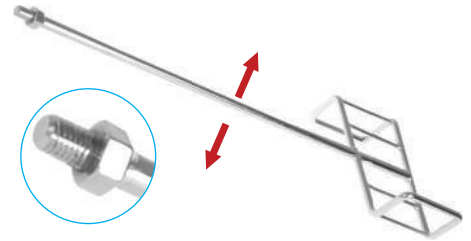

IDEAL FOR TEXTURE COATING

PRO ADAPTOR

FEATURES

- Chrome plated
- For increasing the length of M14 drive shaft

Product code	Barcode	Drive	Length mm	Inner Qty	Outer Qty
OX-P121515	9341231011016	M14	150	3	60



PRO MIXING DRILL ADAPTOR - HEX/M14(F)

FEATURES

- Chrome plated
- For turning M14 thread into 10mm hex

Product code	Barcode	Description	Inner Qty	Outer Qty
OX-P121801	9341231038013	OX Pro Mixing Drill Adaptor - Hex/M14(F)	15	90



Tiling Tools

“I use OX tools because of the design and quality considered in the range, which I haven't found in other suppliers. I started off using the Notch trowels with the comfort and durability making me throw away the other trowels. The 7 piece level set gets a good workout, using them every day screeding and making sure my floors and walls are bang on, they are still as accurate as the day that I got them.”

Chris Forster | Flowstate Tiling





PRO STRAIGHT SET TILE NIPPER – TWO STRAIGHT

FEATURES

- Strong drop forged body
- Cuts round and irregular shapes
- OXGRIP handles
- Tungsten – solid tip, set in and ground/polished finished

Product code	Barcode	Size	Inner Qty	Outer Qty
OX-P152180	9341231029462	8" / 200mm	12	60



PRO STRAIGHT SET TILE NIPPER – TWO CURVED

FEATURES

- Strong drop forged body
- Cuts round and irregular shapes
- OXGRIP handles
- Tungsten – solid tip, set in and ground/polished finished

Product code	Barcode	Size	Inner Qty	Outer Qty
OX-P152280	9341231029479	8" / 200mm	12	60



PRO PARROT BEAK TILE NIPPER

FEATURES

- Strong drop forged body
- Cuts round and irregular shapes
- OXGRIP handles
- Tungsten – solid tip, set in and ground/polished finished

Product code	Barcode	Size	Inner Qty	Outer Qty
OX-P152475	9341231029516	7½" / 190mm	12	72



TRADE TRIM /FILLET CUTTER

FEATURES

- Chrome plated
- Integral angle gauge
- Soft moulded hand grips

Product code	Barcode	Size	Inner Qty	Outer Qty
OX-T151010	9341231029523	8" / 216mm	6	48





Tiling Tools

TRADE NOTCHED TILING TROWEL



New

FEATURES

- Flexible blade
- Comfortable soft grip
- Heavy duty aluminium shank
- Carbon Steel

Product code	Barcode	Blade Size	Inner Qty	Outer Qty
OX-T535106	5060530354122	6 x 6mm	8	16
OX-T535108	5060530354139	8 x 8mm	8	16
OX-T535110	5060530354146	10 x 10mm	8	16
OX-T535112	5060530354153	12 x 12mm	8	16
OX-T535115	5060530357819	15 x 15mm	8	16

TRADE V NOTCH TROWEL



FEATURES

- Carbon steel blade & timber handle
- Aluminium shank
- Size: 115 x 280mm

Product code	Barcode	V Size	Inner Qty	Outer Qty
OX-T401804	9341231029721	4mm	8	16

PRO NOTCH TROWEL



FEATURES

- Carbon steel blade & aluminium shank
- OXGRIP handle
- Size: 115 x 280mm

Product code	Barcode	Size	Inner Qty	Outer Qty
OX-P013406	9341231024146	6 x 6mm	4	24
OX-P013408	9341231024153	8 x 8mm	4	24
OX-P013410	9341231024160	10 x 10mm	4	24
OX-P013412	9341231024177	12 x 12mm	6	36



PRO SQUARE FRONT TROWEL

FEATURES

- High quality carbon steel blade square front trowel
- Heavy duty forged straight shank design
- OXGrip handle with finger stop protection

Product code	Barcode	Size	Inner Qty	Outer Qty
OX-P013716	9341231051425	160mm	4	32
OX-P013718	5060242330506	180mm	4	32
OX-P013720	9341231022517	200mm	6	32



PRO GAUGING TROWEL

FEATURES

- Welded shank
- Precision taper ground blade
- OXGRIP handle
- 'S' style shank - will 'hang' on the side of a bucket

Product code	Barcode	Size	Inner Qty	Outer Qty
OX-P011407	5060242330261	3½ x 7" / 88 x 178mm	6	60
OX-P011408	9341231010804	3½ x 8" / 95 x 203mm	6	60



TRADE WASH KIT - 24L

FEATURES

- Removable plastic grid on stilts for easy and effective rinsing of the sponge float
- Large 24 litre container made from impact resistant plastic
- 4 lockable swivel wheels and large carry handle for easy moving and positioning around the worksite
- 3 adverse rollers on sliders to allow variable positioning

Product code	Barcode	Size	Inner Qty	Outer Qty
OX-T140424	9341231040320	24L	1	6





Tiling Tools

PRO SINGLE CUP RUBBER/ALUMINIUM SUCTION LIFTER



New

FEATURES

- 4.5" pro suction cup, plastic cup & rubber pad
- Suits most substrates including uneven surfaces
- Metal handle & valve
- 40kg Lifting Capacity

Product code	Barcode	Size	Inner Qty	Outer Qty
OX-P170545	9341231043598	4.5"	12	24

PRO SINGLE CUP RUBBER SUCTION LIFTER



FEATURES

- Easy single handed use
- Grips on to any smooth flat surface
- Easy to use - press-on for suction - lift lipped edge for release
- Max lift capacity 20kg

Product code	Barcode	Cup Size	Inner Qty	Outer Qty
OX-P170403	9341231026041	3" / 80mm	12	72

PRO CONTOUR GAUGE



New

FEATURES

- Made of high quality, durable ABS plastic
- Anti-corrosion and anti-rust
- Replicate the shape of mouldings or match cut outs exactly for tiling, woodworking, carpet etc.
- Double-inch and centimetre graduations on contour gauge
- Profile lock / unlock function & Magnetic Backing

Product code	Barcode	Size	Inner Qty	Outer Qty
OX-P02410	9341231051401	-	12	24



PRO 7 PIECE TILERS SET – COMPLETE LEVEL SET

FEATURES

- Magnified centre vial
- Made from structural aircraft alloy
- Plexiglass shock proof vials
- Accuracy +/- 0.5mm/m
- 2 Vials: 300mm x 1, 400mm x 1, 600mm x 1, 800mm x 1, 1000mm x 1
- 3 Vials: 1200mm x 1, 2000mm x 1

Product code	Barcode	Content	Inner Qty	Outer Qty
OX-P21SET7	9341231034152	7 pieces	1	4

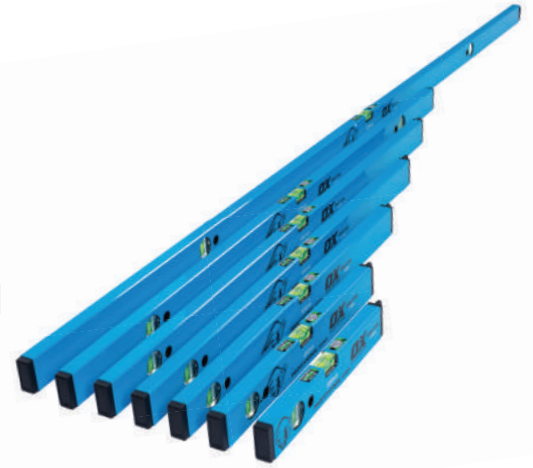

PRO TILERS LEVEL - 2 VIAL

FEATURES

- Magnified centre vial
- Made from structural aircraft alloy
- Plexiglass shock proof vials
- Accuracy +/- 0.5mm/m

Product code	Barcode	Length	Inner Qty	Outer Qty
OX-P021204	9341231030048	400mm	3	30
OX-P021206	9341231030055	600mm	3	6
OX-P021208	9341231030062	800mm	3	3
OX-P021212	9341231045042	1200mm	1	10



PRO TILERS LEVEL - 3 VIAL

FEATURES

- Magnified centre vial
- Made from structural aircraft alloy
- Plexiglass shock proof vials
- Accuracy +/- 0.5mm/m

Product code	Barcode	Length	Inner Qty	Outer Qty
OX-P023115	9341231030109	1500mm	3	6





Tiling Tools

PRO NARROW TILE GROUTER

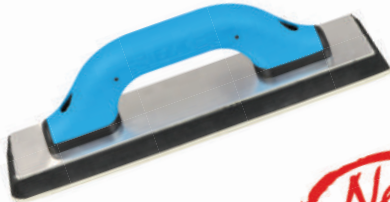

New

FEATURES

- Bevelled edges and rounded corners
- Rubber pad and cemented aluminium backing plate
- Offset handle for dense / cove work
- 305mm x 76mm x 13mm

Product code	Barcode	Size	Inner Qty	Outer Qty
OX-P142812	9341231051111	305mm x 75mm	6	60

PRO SOFT RUBBER GROUT FLOAT



New

FEATURES

- Soft body for cleaning textured tile and stone
- Heavy duty- pure urethane construction
- Ergonomic plastic handle
- Easy to spread, leaves surfaces clean

Product code	Barcode	Size	Inner Qty	Outer Qty
OX-P142910	9341231051128	-	3	6

PRO POINTED RUBBER GROUTER



FEATURES

- Timber handle
- Foam-rubber blade with steel insert - for rigidity

Product code	Barcode	Size	Inner Qty	Outer Qty
OX-P011995	9341231029844	3½ x 9½" / 86 x 240mm	6	72

PRO RECTANGULAR DOUBLE RUBBER GROUTER



FEATURES

- Ergonomic plastic handle
- Gum rubber blade with bevelled edges
- Plastic backer with foam cushion for even pressure

Product code	Barcode	Size	Inner Qty	Outer Qty
OX-P011812	9341231029875	4 x 12" / 100 x 300mm	12	48
OX-P011895	9341231027192	4 x 9½" / 100 x 240mm	12	48



OX DIAMOND HAND POLISHING PADS

FEATURES

- Used for the smoothing of ceramic and porcelain tile edges
- Hard wearing synthetic diamond surface
- Comfortable foam grip
- Grit 60, 200, 400, 600



Product code	Barcode	Grit	Inner Qty	Outer Qty
OX-DHPP-60	9341231051364	60 Grit	10	200
OX-DHPP-200	9341231051371	200 Grit	10	200
OX-DHPP-400	9341231051388	400 Grit	10	200
OX-DHPP-600	9341231051395	600 Grit	10	200

TRADE TILE LEVELLING SYSTEM KIT

FEATURES

- Aligns tiles of different thicknesses
- Holds tiles securely until adhesive has set
- Ensures a level surface. 100% parallel, symmetrical joint system
- Kit includes: reusable pliers, 1.5mm spacer clips qty. 100 & reusable wedges qty. 100
- Kit includes bonus 8.5L bucket

Product code	Barcode	Size	Inner Qty	Outer Qty
OX-T163800	9341231051517	-	1	2



Adjustable Pliers



Spacers



Wedges

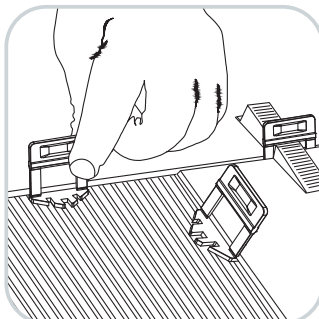

STEP 1
Locate the spacers along the tile edge.

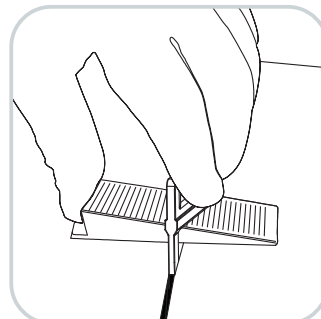

STEP 2
Slide wedge into spacer.

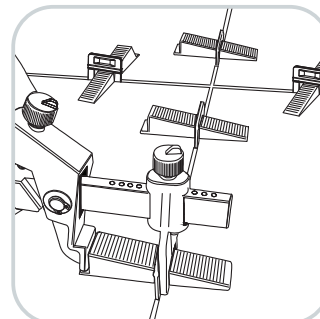

STEP 3
Align pliers and compress until tile is level.

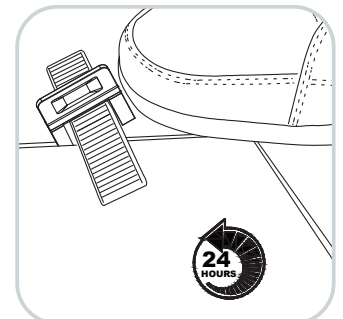

STEP 4
Once adhesive sets, break away easy snap spacer.



Tiling Tools

TRADE TILE LEVELLING SYSTEM - ADJUSTABLE PLIERS



New

FEATURES

- Reusable
- Round base to avoid damage to ceramics
- Metal Design

Product code	Barcode	Size	Inner Qty	Outer Qty
OX-T163801	9341231051340	-	30	60

TRADE TILE LEVELLING SYSTEM - 1.5MM SPACERS



New

FEATURES

- Unique easy break design that breaks underneath the tile every time
- 1.5mm thick tile clip is suitable for 6 - 12mm thick tiles
- Available in 1mm & 1.5mm
- 500pc kit includes bonus 10L bucket

Product code	Barcode	Quantity	Inner Qty	Outer Qty
OX-T163811	9341231051326	100pcs	12	24
OX-T163815	9341231051333	500pcs	12	24



100pcs



500pcs

TRADE TILE LEVELLING SYSTEM WEDGE



New

FEATURES

- Strong polymer construction
- Reinforced rib design for durability
- Extended end cap to assist hammering
- Includes bonus 20L bucket

Product code	Barcode	Quantity	Inner Qty	Outer Qty
OX-T163850	9341231051319	500pcs	1	2

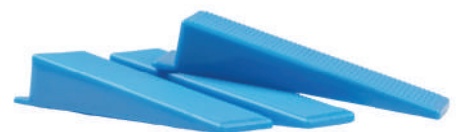



TRADE TILE WEDGES 5MM

FEATURES

- Ideal for maintaining level horizontal grout lines
- Crucial for achieving a level first row of wall tiles
- Avoids tile slippage on vertical surfaces
- 5mm wedges, 500pcs / 1000pcs

Product code	Barcode	Quantity	Inner Qty	Outer Qty
OX-T160605	9341231029264	500pcs	66	132
OX-T160610	9341231051227	1000pcs	35	70



500pcs

1000pcs



TRADE CROSS SHAPED TILE SPACERS

FEATURES

- Durable tile spacers to help space tiles
- Even to give a professional finish
- Professional grade plastic
- Available in a range of sizes
- Extended design for easy grip and placement

Product code	Barcode	Size / Quantity	Inner Qty	Outer Qty
OX-T163401	9341231051234	1.5mm / 500pcs	66	132
OX-T163402	9341231051258	2mm / 500pcs	40	80
OX-T163403	9341231051272	3mm / 500pcs	32	64
OX-T163405	9341231051296	5mm / 500pcs	18	36
OX-T163501	9341231051241	1.5mm / 1000pcs	24	48
OX-T163502	9341231051265	2mm / 1000pcs	12	24
OX-T163503	9341231051289	3mm / 1000pcs	20	40
OX-T163505	9341231051302	5mm / 1000pcs	10	20



500pcs

1000pcs





Tiling Tools

PRO VELCRO SPONGE HOLDER



FEATURES

- One piece handle and blade with co-moulded OXGRIP
- Velcro quick change base - glued and stapled

Product code	Barcode	Size	Inner Qty	Outer Qty
OX-P012927	9341231030208	5 x 10½" / 130 x 270mm	2	10

PRO VELCRO SLOTTED HYDRO SPONGE



FEATURES

- The ultimate tilers sponge - made from 'Hydro' material for ultimate water holding properties
- Open cell design with the 'Hydro' material, creates the most effective dirt release during 'compression load deflection
- The OX slotted surface design creates multiple edges to perform the cleanest 'wipe' after one swipe

Product code	Barcode	Size	Inner Qty	Outer Qty
OX-P250215	9341231030215	6 x 12 x 1½" / 150 x 300 x 35mm	1	12



PRO SLOTTED HYDRO SPONGE FLOAT



FEATURES

- One piece moulded handle and blade
- Sponge made from 'Hydro' material for ultimate water holding properties
- Open cell design

Product code	Barcode	Size	Inner Qty	Outer Qty
OX-P404814	9341231035104	5½ x 11" / 140 x 280mm	10	40





PRO HYDRO SPONGE FLOAT WITH PROFILE BASE

FEATURES

- Soft grip handle for ultimate grip and comfort
- 30mm hydro-sponge pad, highly absorbent
- Profiled for easier cleaning

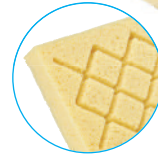

Product code	Barcode	Size	Inner Qty	Outer Qty
OX-P140614	9341231040399	5½ x 11" / 140 x 280mm	4	40

PRO SLOTTED HYDRO SPONGE

FEATURES

- The ultimate tilers sponge - made from 'Hydro' material for ultimate water holding properties
- Open cell design with the 'Hydro' material, creates the most effective dirt release during 'compression load deflection'
- The OX slotted surface design creates multiple edges to perform the cleanest 'wipe' after one swipe



Product code	Barcode	Size	Inner Qty	Outer Qty
OX-P250113	9341231030192	200 x 130 x 50mm	12	96

PRO VELCRO SLOTTED HYDRO SPONGE

FEATURES

- All-purpose type sponge for general cleaning
- Coarse pore for removal of heavy dirt
- Consists of large and small cell structure



Product code	Barcode	Size	Inner Qty	Outer Qty
OX-P250311	9341231030154	110 x 165 x 65mm	12	14
OX-P250313	9341231030161	130 x 200 x 70mm	12	144

PRO HYDRO HAND SPONGE

FEATURES

- The ultimate tilers sponge - made from 'Hydro' material for ultimate water holding properties
- 'Open cell' design with the 'Hydro' material, creates the most effective dirt release during 'compression load deflection'



Product code	Barcode	Size	Inner Qty	Outer Qty
OX-P250411	9341231030178	110 x 165 x 65mm	6	24
OX-P250413	9341231030185	130 x 200 x 70mm	12	24



Tiling Tools

TRADE WALL SCRAPER



FEATURES

- Strips various product off many surfaces

Product code	Barcode	Blade Size	Inner Qty	Outer Qty
OX-T050604	9341231013980	100mm	12	72
OX-T050606	9341231026010	150mm	12	48

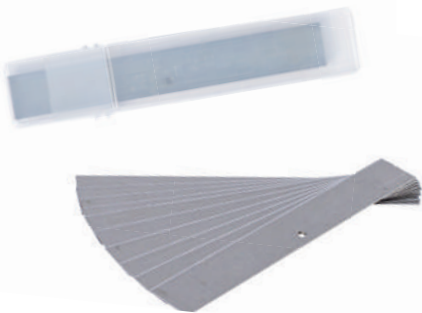

- Replacement blades
- 10 blades per pack (OX-T059504)
- 5 blades per pack (OX-T059506)

Product code	Barcode	Blade Size	Inner Qty	Outer Qty
OX-T059504	9341231036255	100mm	25	200
OX-T059506	9341231013997	150mm	10	100

PRO HEAVY DUTY SCRAPER



FEATURES

- Chrome plated shaft
- Triple screw blade clamp
- Power weighed OXGRIP end
- Size: 450mm

Product code	Barcode	Blade Size	Inner Qty	Outer Qty
OX-P050105	9341231029912	5" / 127mm	4	12



- Replacement blades - 10pk
- Made from high quality carbon steel
- Suits OX-P050105

Product code	Barcode	Size	Inner Qty	Outer Qty
OX-P059905	9341231029929	127 x 19 x 1mm	4	12



TRADE MULTI TOOL SILICONE REMOVER & SMOOTHER

FEATURES

- Effective removal of silicone and grout
- Perfect to assist with preparation before the use of corner tape
- Multi-Tool – Silicone remover and smoother tool
- Multiple profiles for different smoothing options

Product code	Barcode	V Size	Inner Qty	Outer Qty
OX-T051801	9341231051135	4mm	4	32



New

PRO GROUT REMOVER

FEATURES

- Tungsten carbide tipped blade
- Ergonomic body and grip with blade storage compartment in the hilt
- Size: 210mm

Product code	Barcode	Blade Size	Inner Qty	Outer Qty
OX-P130201	9341231029899	50mm	12	72



- Replacement blades (2 pack)
- Tungsten carbide tipped blade
- Suits OX-P130201

Product code	Barcode	Size	Inner Qty	Outer Qty
OX-P139801	9341231029905	50mm / 2in	24	480

Striking & Struck Tools

“I've been using a variety of tools from the OX striking range and I definitely rate them. As always, you're a little skeptical moving from some of the traditional or legacy brands that are available, however I've got to say this gear doesn't miss a beat. It's durable, functional, comfortable and 100% gets the job done every time. I'd recommend it!”

Aaron | A&M Landscaping





ULTRASTRIKE



PRO ULTRASTRIKE CLAW HAMMER

FEATURES

- Side nail remover
- Magnetic nail starter

Product code	Barcode	Size	Inner Qty	Outer Qty
OX-P086520	9341231049910	20oz / 570g	4	24
OX-P086524	9341231051029	24oz / 680g	4	16



LIFETIME GUARANTEE

PRO ULTRASTRIKE STRAIGHT CLAW HAMMER

FEATURES

- Side nail remover
- Extended framing shaft

Product code	Barcode	Size	Inner Qty	Outer Qty
OX-P087320	9341231054082	20oz / 560g	4	24
OX-P087322	9341231054266	22oz / 620g	4	16



LIFETIME GUARANTEE



Striking & Struck Tools



PRO CLAW HAMMER

FEATURES

- Non-slip grip handle with shock reduction
- Precision balanced
- Forged, one piece steel construction
- High quality steel for durability

Product code	Barcode	Size	Inner Qty	Outer Qty
OX-P080116	5060242337994	16oz / 450g	4	24
OX-P080120	9328217003401	20oz / 560g	4	24
OX-P080124	5060242338007	24oz / 680g	4	24

LIFETIME GUARANTEE



PRO STRAIGHT CLAW HAMMER

FEATURES

- Non-slip grip handle with shock reduction
- Precision balanced
- Forged, one piece steel construction
- High quality steel for durability

Product code	Barcode	Size	Inner Qty	Outer Qty
OX-P082920	5060242338502	20oz / 560g	4	24

LIFETIME GUARANTEE



PRO FRAMING HAMMER

FEATURES

- Straight claw hammer designed for frame work
- Long handle for greater impact
- Non-slip grip handle with shock reduction
- Forged, one piece steel construction
- Precision balanced

Product code	Barcode	Size	Inner Qty	Outer Qty
OX-P082328	5060242338014	28oz / 790g	4	16

LIFETIME GUARANTEE



PRO FIBREGLASS CLAW HAMMER

FEATURES

- Fibreglass shaft with an injection moulded grip
- Non-slip grip with shock reduction
- Precision balanced



LIFETIME GUARANTEE

Product code	Barcode	Size	Inner Qty	Outer Qty
OX-P081620	5060242337451	20oz / 570g	4	24

TRADE FIBREGLASS CLAW HAMMER

FEATURES

- Hardened & Tempered Steel Head
- Unique OX Fibreglass Handle
- Ergonomic TPR Grip
- Lightweight feel and perfect balance



Product code	Barcode	Size	Inner Qty	Outer Qty
OX-T081220	9341231019982	20oz / 570g	6	24

TRADE FIBREGLASS STRAIGHT CLAW HAMMER

FEATURES

- Hardened & Tempered Steel Head
- Unique OX Fibreglass Handle
- Ergonomic TPR Grip
- Lightweight feel and perfect balance



Product code	Barcode	Size	Inner Qty	Outer Qty
OX-T086020	9341231043888	20oz / 570g	6	24



Striking & Struck Tools

PRO BRICK HAMMER



FEATURES

- Accurately ground chisel end for clean cutting
- Non-slip grip handle with shock reduction
- Forged, one piece steel construction
- Precision balanced

Product code	Barcode	Size	Inner Qty	Outer Qty
OX-P082424	5060242338021	24oz / 680g	4	24

LIFETIME GUARANTEE

TRADE BRICK HAMMER



FEATURES

- Hardened and tempered steel head
- Solid core fibreglass handle
- Ergonomic rubber grip
- Head weight 24oz

Product code	Barcode	Handle Length	Inner Qty	Outer Qty
OX-T081024	9341231013638	24oz / 680g	6	24

PRO DRYWALL HAMMER



FEATURES

- Crowned, scored hammer head to reduce the chance of impact marks on plasterboard
- Cutaway and notched cutting blade for withdrawing nails and cutting laths
- Non-slip grip handle with shock reduction

Product code	Barcode	Size	Inner Qty	Outer Qty
OX-P082614	5060242338038	14oz / 400g	4	24

LIFETIME GUARANTEE



PRO ROCK PICK

FEATURES

- Accurately ground point end for accurate picking
- Non-slip grip handle with shock reduction
- Forged, one piece steel construction
- Precision balanced

Product code	Barcode	Size	Inner Qty	Outer Qty
OX-P083222	9341231035074	22oz / 620g	4	24



LIFETIME GUARANTEE

PRO CLUB HAMMER

FEATURES

- Forged, one piece steel construction
- Non-slip grip handle with shock reduction
- High quality steel for durability

Product code	Barcode	Size	Inner Qty	Outer Qty
OX-P082703	5060242338045	3lb / 1.3kg	4	12
OX-P082704	5060242338052	4lb / 1.8kg	4	12



LIFETIME GUARANTEE

TRADE FIBREGLASS CLUB HAMMER

FEATURES

- Hardened high quality steel
- Extremely strong fibreglass handle
- Available in 3LB & 4LB

Product code	Barcode	Size	Inner Qty	Outer Qty
OX-T081303	9341231013645	3lb / 1.3kg	6	12
OX-T081304	5060242332241	4lb / 1.8kg	6	12





Striking & Struck Tools

TRADE 3LB BRICKLAYERS CLUB HAMMER



FEATURES

- Flat face finish
- Manufactured from FineGrain High Carbon Steel
- Drop Forged, Heat Treated, Induction hardened & tempered with fine polished faces

Product code	Barcode	Size	Inner Qty	Outer Qty
OX-T086115	9341231018985	3lb / 1.3kg	4	16

TRADE FIBREGLASS DEMOLITION HAMMER



FEATURES

- Hardened and tempered steel head
- Solid core fibreglass handle
- Ergonomic rubber grip

Product code	Barcode	Size	Inner Qty	Outer Qty
OX-T082004	9341231013676	4lb / 1.8kg	4	8

PRO 6LB MINI SLEDGE HAMMER



FEATURES

- 6LB Mini Sledge Hammer
- manufactured from fine grain high carbon steel
- Drop forged, heat treated, induction hardened & tempered with fine polished faces
- Clear lacquer finish to deter corrosion on hammer head
- Straight grain 400mm hickory handle
- Milled hammer face with chamfered edges
- Tapered eye hole to prevent accidental handle pull out

Product code	Barcode	Size	Inner Qty	Outer Qty
OX-P085906	9341231017926	46 x 3 x 15	1	4



TRADE FIBREGLASS SLEDGE HAMMER

FEATURES

- Hardened high quality steel
- Extremely strong fibreglass handle
- Available in 7LB, 10LB, 12LB & 14LB

Product code	Barcode	Size	Inner Qty	Outer Qty
OX-T081507	9341231013706	7lb / 3.2kg	2	4
OX-T081510	5060242332265	10lb / 4.5kg	2	4
OX-T081512	9341231013720	12lb / 5.4kg	1	2
OX-T081514	9341231013737	14lb / 6.3kg	2	4



PRO HICKORY HANDLE SLEDGE HAMMER

FEATURES

- Hardened high quality steel
- Genuine hickory handle
- Fitted with steel wedges

Product code	Barcode	Size	Inner Qty	Outer Qty
OX-P080204	9341231001918	4lb / 1.8kg	1	2
OX-P080207	9341231001925	7lb / 3.2kg	1	2
OX-P080210	9341231001932	10lb / 4.5kg	1	2
OX-P080214	9341231001949	14lb / 6.3kg	1	2



PRO ONE PIECE RUBBER MALLET

FEATURES

- White non marking rubber
- Steel reinforcement core
- Comfortable grip
- One piece moulded rubber

Product code	Barcode	Size	Inner Qty	Outer Qty
OX-P080610	9341231011733	35oz / 1000g	4	12





Striking & Struck Tools

PRO WHITE RUBBER MALLET



FEATURES

- Quality, durable rubber mallet

Product code	Barcode	Size	Inner Qty	Outer Qty
OX-P081832	5060242332333	32oz / 907g	6	24

TRADE BLACK RUBBER MALLET



FEATURES

- Quality, durable rubber mallet
- Solid core fibreglass handle
- Ergonomic rubber grip

Product code	Barcode	Size	Inner Qty	Outer Qty
OX-T081724	5060242332296	24oz / 680g	6	24

PRO SINGLE ENDED SCUTCH HAMMER



FEATURES

- Hickory handle
- High quality drop forged steel head
- Head weight 28oz

Product code	Barcode	Size	Inner Qty	Outer Qty
OX-P080528	9341231001901	28oz / 790g	4	24



PRO DOUBLE ENDED SCUTCH HAMMER

FEATURES

- High quality drop forged steel head
- Head weight 22oz
- Hickory handle

Product code	Barcode	Size	Inner Qty	Outer Qty
OX-P080522	9341231001895	22oz / 620g	4	24



PRO SCUTCH COMBS HOLDERS

FEATURES

- For detachable stone dressing combs
- Heavy duty high carbon steel
- Hardened & tempered for durability

Product code	Barcode	Size	Inner Qty	Outer Qty
OX-P090310	9341231020759	200 x 25mm / 8 x 1"	6	30
OX-P090315	9341231020766	200 x 38mm / 8 x 1 1/2"	6	30



PRO SCUTCH COMBS

FEATURES

- To fit into a scutch comb holder
- For preparation of surface prior to re-rendering
- Three different sizes – 25, 38 & 50mm

Product code	Barcode	Size	Inner Qty	Outer Qty
OX-P080725	9341231010712	25mm	10	40
OX-P080738	9341231010729	38mm	4	40
OX-P080750	9341231010736	50mm	4	16

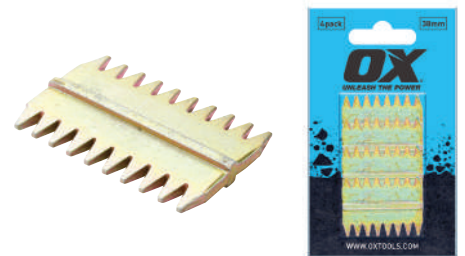

PRO CONCRETE CHISEL

FEATURES

- Forged chrome vanadium steel
- Dual hand guard
- Soft grip handle
- For cutting & breaking of concrete

Product code	Barcode	Size	Inner Qty	Outer Qty
OX-P092501	5060242334535	3/4" x 12" / 20 x 300mm	5	20





Striking & Struck Tools

TRADE ELECTRICIANS BOLSTER



FEATURES

- Drop forged steel
- Rubber grip handle

Product code	Barcode	Blade Width	Inner Qty	Outer Qty
OX-T090502	5060242331497	2 1/4" / 57mm	4	32

PRO ELECTRICIAN'S CHISEL



FEATURES

- Forged chrome vanadium steel
- Dual hand guard
- Soft grip handle
- For cutting & trimming of wood, wallboard & masonry

Product code	Barcode	Blade Width	Inner Qty	Outer Qty
OX-P092002	5060242334573	2 1/4" / 55mm	5	20

PRO FLOOR CHISEL



FEATURES

- Forged chrome vanadium steel
- Dual hand guard
- Soft grip handle
- For cutting, prying & ripping of nails & hard wood flooring

Product code	Barcode	Blade Width	Inner Qty	Outer Qty
OX-P092103	5060242334542	3" / 76mm	5	20

TRADE BRICK BOLSTER



FEATURES

- Drop forged steel
- OXGRIP handle

Product code	Barcode	Blade Width	Inner Qty	Outer Qty
OX-T090945	5060242332227	4 1/2" / 115mm	4	16



PRO COLD CHISEL

FEATURES

- Forged chrome vanadium steel
- Dual hand guard
- Soft grip handle
- For cutting & shaping iron, steel, aluminium, copper, brass, nuts & bolts

Product code	Barcode	Blade Width	Inner Qty	Outer Qty
OX-P092401	5060242334566	1" / 25mm	5	20



PRO BRICK BOLSTER

FEATURES

- Forged chrome vanadium steel
- Dual hand guard
- Soft grip handle
- For cutting & splitting of bricks & masonry

Product code	Barcode	Blade Width	Inner Qty	Outer Qty
OX-P092303	50602423334511	3" / 76mm	5	20
OX-P092345	5060242339424	4½" / 115mm	5	20



TRADE COLD CHISEL

FEATURES

- One piece forged steel for ultimate strength
- Hardened & tempered for durability
- For cutting & shaping masonry

Product code	Barcode	Size	Inner Qty	Outer Qty
OX-T090112	5060242330865	1" X 12" / 25 X 300mm	6	24
OX-T091218	5060242331480	¾" X 18" / 20 X 450mm	4	12



PRO GROOVED PLUGGING CHISEL

FEATURES

- High quality carbon steel
- Hexagonal shaft
- Fluted design - to prevent 'jamming'
- Chamfered striking end

Product code	Barcode	Size	Inner Qty	Outer Qty
OX-P090210	9341231022395	250 x 6mm	4	20





Striking & Struck Tools



PRO DEMOLITION BAR

FEATURES

- Heat treated, forged steel
- For pulling, lifting or prying
- Powder coated to provide maximum resistance to rusting

Product code	Barcode	Size	Inner Qty	Outer Qty
OX-P093015	5060242338083	15" / 390mm	8	48



PRO HEAVY DUTY PRY BAR

FEATURES

- Powder coated finish all steel
- Hardened steel claw
- Ideal for prying formwork

Product code	Barcode	Size	Inner Qty	Outer Qty
OX-P092856	9341231025846	56" / 1425mm	4	16



TRADE WRECKING BAR

FEATURES

- Solid steel wrecking bar
- Forged high carbon steel - one piece

Product code	Barcode	Size	Inner Qty	Outer Qty
OX-T091012	5060242330803	12" / 300mm	10	20
OX-T091018	5060242330810	18" / 450mm	6	12
OX-T091024	5060242330827	24" / 600mm	5	10
OX-T091030	5060242331503	30" / 750mm	5	10
OX-T091036	5060242330834	36" / 900mm	5	10



PRO MOULDING BAR

FEATURES

- Unique hammer head
- Multi-functional moulding bar with extra wide chisel blade
- Comfort non-slip grip handle
- Polished bevelled claw for better access



Product code	Barcode	Size	Inner Qty	Outer Qty
OX-P083110	5060242338076	10" / 250mm	6	48

PRO CLAW BAR

FEATURES

- Unique hammer head
- Multi-functional claw bar for striking, prying & pulling
- Comfort non-slip grip handle
- Polished bevelled claw for better access



Product code	Barcode	Size	Inner Qty	Outer Qty
OX-P083010	5060242339981	10" / 250mm	6	48
OX-P083012	5060242338069	12" / 300mm	6	36

Measuring Tools

“The wide range of measuring tools that are available from OX stand out from the other brands out there! From the tough tapes to the functionality and durability of the carpenters and combi squares the OX range is definitely our go-to for set-out and everyday measuring.”

Jamie Morrison | EST Building





PRO STAINLESS STEEL TAPE MEASURE

FEATURES

- Professional tape measure
- Stainless steel case with over mold for heavy duty use
- Extra tough nylon coated steel 30mm wide blade
- 3.0m stand out
- Large end hook
- Easy access thumb lock

Product code	Barcode	Size	Inner Qty	Outer Qty
OX-P029308	9341231015519	8m	6	36



TRADE DOUBLE LOCKING TAPE MEASURE

FEATURES

- Patented dual locking mechanism
- Shockproof "tuff" casing
- Lanyard Capable

Product code	Barcode	Size	Inner Qty	Outer Qty
OX-T505205	9341231042904	5m	6	48
OX-T505208	9341231042881	8m	12	24

*Free counter display with every purchase of 12 8m tapes.



PRO DURAGRIP TAPE MEASURE

FEATURES

- OXGRIP moulded rubber case
- Triple rivetted hook end
- 25mm wide metric blade

Product code	Barcode	Size	Inner Qty	Outer Qty
OX-P020108	9341231000706	8m	18	36

* Free counter display with every purchase of 18 tapes.



TRADE DURAGRIP TAPE MEASURE

FEATURES

- 25mm wide metric blade
- Ergonomic rubber grip
- Nylon coated steel blade
- Easy access sliding thumb lock
- Shock absorbing blade return bumper

Product code	Barcode	Size	Inner Qty	Outer Qty
OX-T020108	9341231032349	8m	12	48
OX-T020110	9341231034008	10m	12	48

* Free counter display with every purchase of 12 tapes.





Measuring Tools

PRO COMBINATION SQUARE

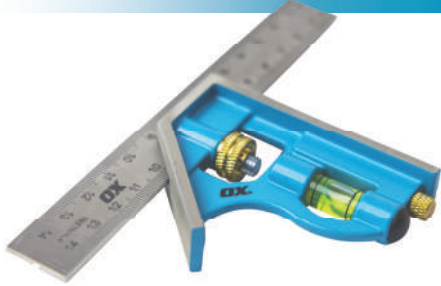

New

FEATURES

- High quality cast and machined sliding stock
- Stainless steel rule engraved with metric graduations
- Can mark 90° and 45° with adjustable depth for repetition marking and scribing

Product code	Barcode	Size	Inner Qty	Outer Qty
OX-P500515	9341231054013	150mm	6	72
OX-P500531	9341231039096	305mm	6	36
OX-P500540	9341231055980	400mm	6	36

PRO HEAVY DUTY ALUMINIUM 'T' SQUARE



FEATURES

- Made from high quality silver anodised structural aircraft aluminium
- Precise 'mm' - graduation markings
- Quadruple rivetted 'T' end to ensure accuracy for a long time

Product code	Barcode	Size	Inner Qty	Outer Qty
OX-P021114	9341231032158	50 x 16" / 1200 x 550mm	4	20

PRO CARPENTER'S SQUARE



FEATURES

- Metric markings with writing area for notes
- Heavy duty carbon steel
- Epoxy coated

Product code	Barcode	Size	Inner Qty	Outer Qty
OX-P021064	9341231001987	24 x 16" / 600 x 400mm	6	24

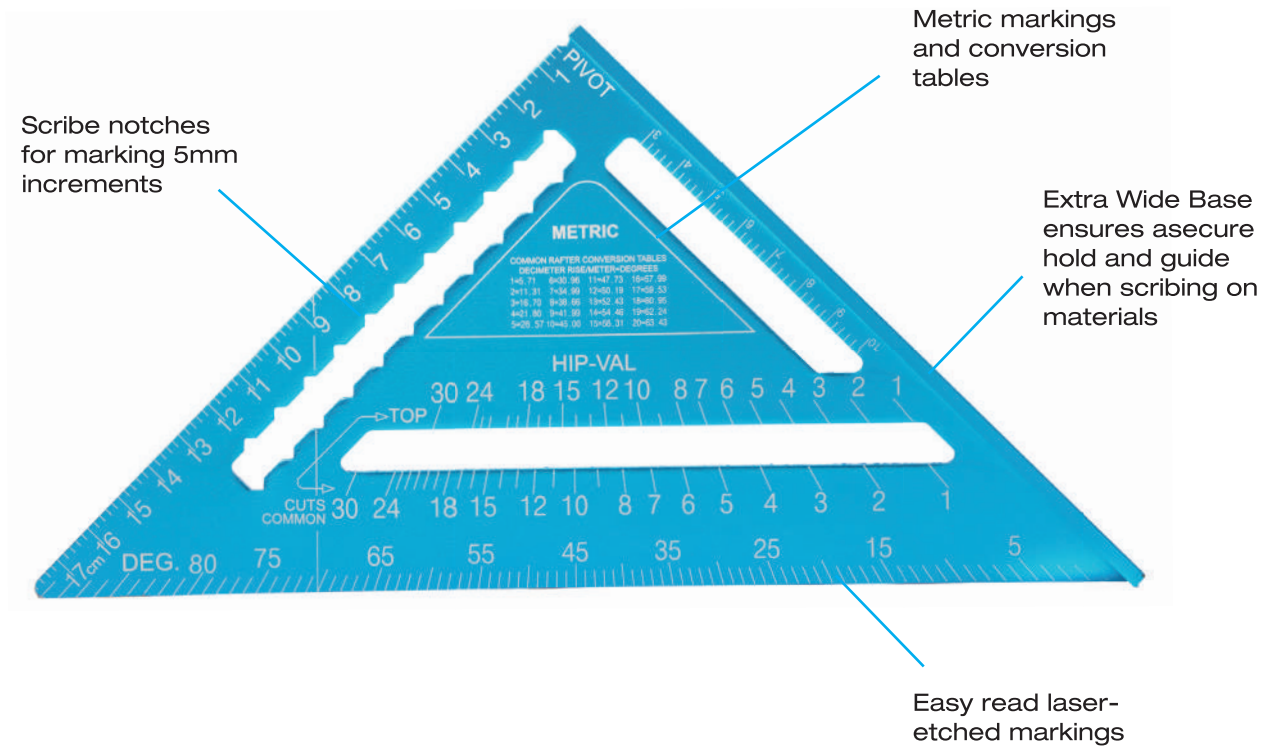

Metric markings and conversion tables

Scribe notches for marking 5mm increments

Extra Wide Base ensures a secure hold and guide when scribing on materials

Easy read laser-etched markings

PRO ALUMINIUM RAFTERS SQUARE

FEATURES

- Scribe notches for marking 5mm increments
- Easy read laser-etched markings
- Metric markings and conversion tables
- Extra-thick extruded aluminium body
- Wide base ensures a secure hold on materials

Product code	Barcode	Size	Inner Qty	Outer Qty
OX-P506518	9341231050473	180mm	10	40
OX-P506530	9341231051036	300mm	8	32



PRO ADJUSTABLE T-SQUARE

FEATURES

- Sliding T-Head
- ABS End-Caps with Ledge
- Tough Anodized Aluminium
- Strong Screw Lock

Product code	Barcode	Size	Inner Qty	Outer Qty
OX-P506212	9341231050039	1200mm	6	18





Measuring Tools

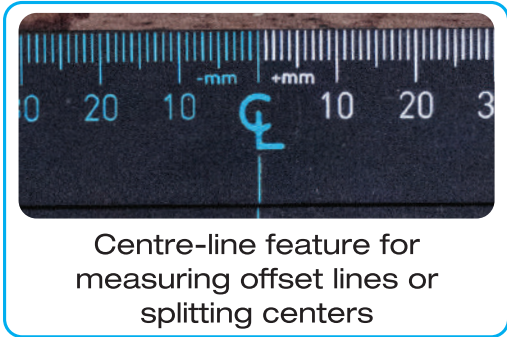

Central Swivel Hinge = Easy angle finder 0-180°

Reinforced hinge and ABS plastic for extra durability

Collapsed width of 45mm - Common framing timber 90mm x 45mm

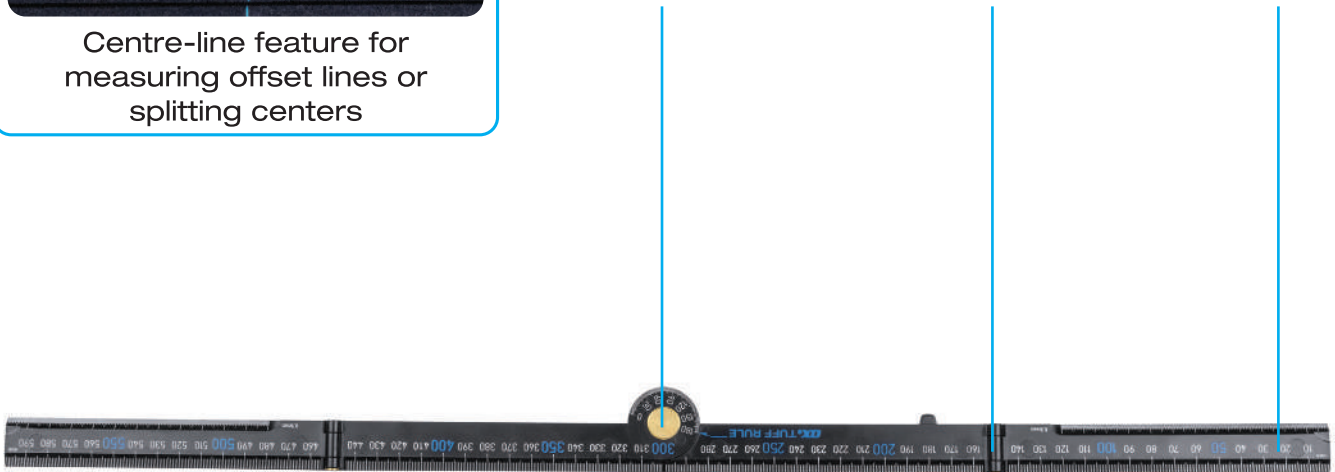

45MM

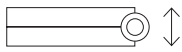

FRAMING TIMBER AND STUD WIDTH— NOGS + DWANGS

180°

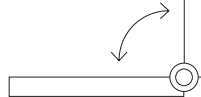

EASY ANGLE FINDER

300MM

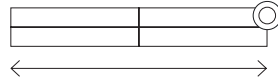

STANDARD SCREW SPACING — GIB + PLY

600MM

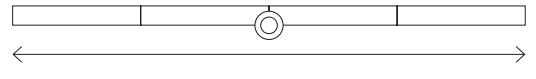

STANDARD WIDTH — 1/2 SHEET + STUD SPACING + FLOOR JOIST SPACING

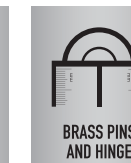
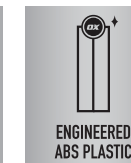



PRO TUFF RULE

FEATURES

- Length 600mm - This is the standard stud wall spacing + floor joist spacing
- Width 45mm - Common framing timber 90mm x 45mm
- Reinforced hinge and ABS plastic for extra durability
- Centre-line feature for measuring offset lines or splitting centres
- Central Swivel Hinge = Easy angle finder 0-180°



New

Product code	Barcode	Colour	Inner Qty	Outer Qty
OX-P507206	9341231054488	Black	40	160
OX-P507216	9341231054815	White	40	160
OX-P507226	9341231055485	Green	40	160
OX-P507236	9341231055492	Cyan	40	160

PRO TUFF RULE DISPLAY PACK

FEATURES

- Includes 18 Tuff Rules
- 6x Pro Tuff Rule - Black (OX-P507206)
- 6x Pro Tuff Rule - White (OX-P507216)
- 6x Pro Tuff Rule - Green (OX-P507226)

Product code	Barcode	Colour	Inner Qty	Outer Qty
OX-P434701	9341231055508	Black	40	160



New

Layout Tools

“Day to day use of the tuff carbon pencil, levels, chalk reels are yet to fail like a lot of other brands used in the past. There’s only one aisle when you walk into that tool shop now that you walk down because the quality of these products you know are the best!”

Jye Green | EST Building



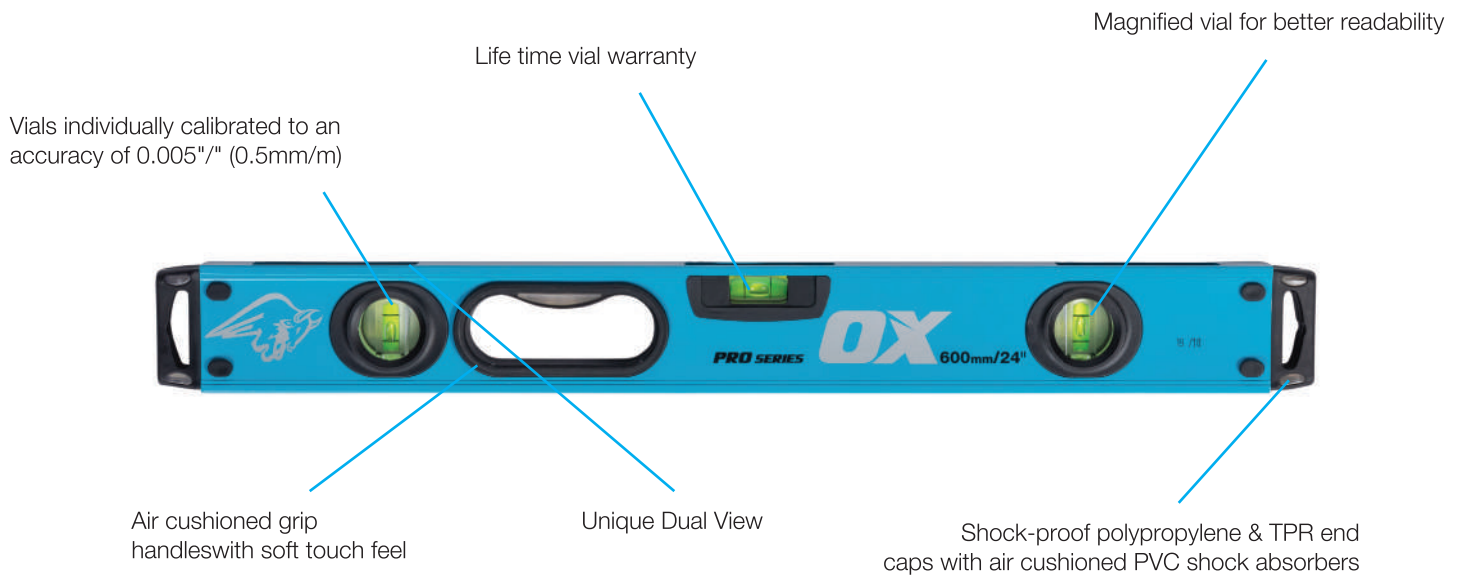

PRO SPIRIT LEVEL

FEATURES

- The strongest level EVER or your money back!
- Unique dual view
- Silicone air cushioned handles
- Shock proof end caps
- Two milled surfaces
- One horizontal and two vertical vials



Product code	Barcode	Size	Inner Qty	Outer Qty
OX-P024406	5060242333897	600mm	4	40
OX-P024408	5060242333903	800mm	4	40
OX-P024409	5060242333910	900mm	4	40
OX-P024412	5060242333934	1200mm	4	40
OX-P024418	5060242333941	1800mm	4	128
OX-P024420	5060242333958	2000mm	4	128
OX-P024424	5060242333965	2400mm	4	128

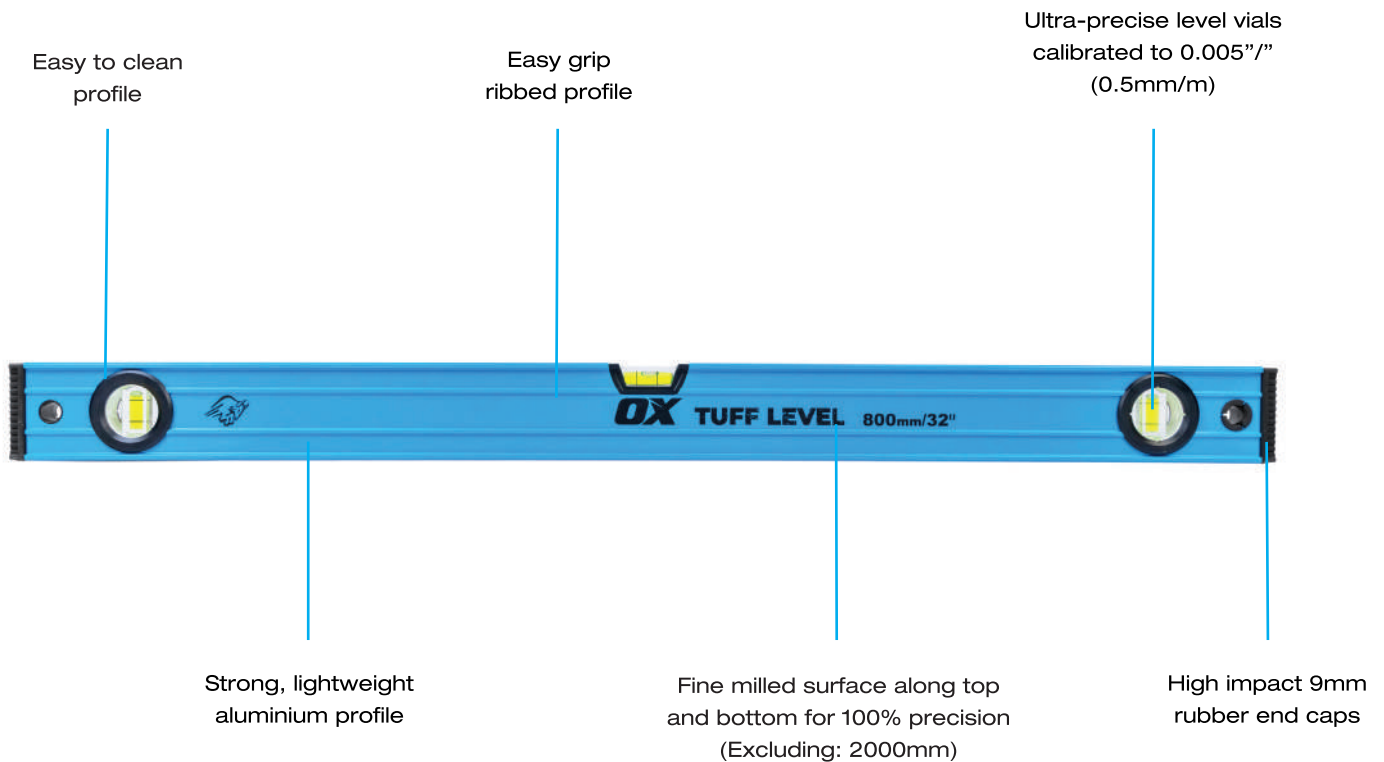

PRO TUFF LEVEL

FEATURES



New

- Built and designed for the toughest work site conditions
- Ultra-precise level vials calibrated to 0.005"/" (0.5mm/m)
- Fine milled surface along top and bottom for 100% precision
- Easy to clean profile
- Easy grip ribbed profile
- Strong, lightweight aluminium profile
- High impact 9mm rubber end caps

Product code	Barcode	Description/Size	Inner Qty	Outer Qty
OX-P503406	9341231038891	600mm	4	12
OX-P503408	9341231054242	800mm	4	12
OX-P503412	9341231038907	1200mm	4	12
OX-P503420	9341231054259	2000mm	4	12



TRADE LEVEL SET - 4PK

FEATURES

- 3 Solid Acrylic Vials with Accuracy of .05mm or .0005in/in
- UV Resistant Vials
- Milled Surface on Base up to 1200mm Length
- Shock Absorbing Rubber End Caps
- Lifetime Vial Warranty
- Strong, Lightweight Aluminium Profile
- Includes: 600mm, 1200mm, 1800mm Trade Levels & 230mm Torpedo Level



Product code	Barcode	Size	Inner Qty	Outer Qty
OX-T500404	5060359914729	600mm, 1200mm, 1800mm & 230mm	4	6



TRADE TORPEDO LEVEL – 230MM

FEATURES

- Light weight trade torpedo level
- 3 easy to read vials (horizontal, vertical, 45 degrees)
- Magnetic V-groove for pipe work and scaffolding
- Tough rubber end caps



20
BOX

Product code	Barcode	Size	Inner Qty	Outer Qty
OX-T026323	9341231040214	230mm	20	80

* Free counter display with every purchase of 20 torpedo levels





Layout Tools

PRO TORPEDO LEVEL



FEATURES

- Die cast aluminium body
- 3 Solid block vials
- Fitted horizontal vial for direct view of bubble
- Fine milled surface with V-groove for accurate and easy placement on pipes and curved surfaces
- Accuracy $<0.0005'' / ''$ (0.5mm/m)

Product code	Barcode	Size	Inner Qty	Outer Qty
OX-P027625	5060242338854	230mm	5	40

PRO CROSS BEAM LASER LEVEL



FEATURES

- Green Beam
- Laser Class: 2
- Level Accuracy: $\pm 0.2\text{mm/m}$
- IP65 - Water & Dust Proof
- Self-Levelling Range: 3°
- Working Range: Indoor: 30m, Outdoor: 60m with detector
- Power: 3x1.5 V LR6 (AA)
- Tilt Mode

Product code	Barcode	Size	Inner Qty	Outer Qty
OX-P502901	5060530351763	-	1	4

PRO ALUMINIUM CHALK LINE REEL



FEATURES

- Durable zinc alloy case
- Self locking winder handle
- Easy slide fill operation

Product code	Barcode	Size	Inner Qty	Outer Qty
OX-P020330	9341231011023	100ft / 30m	6	96



SCAN HERE TO LEARN MORE



PRO ALUMINIUM KEVLAR® CHALK LINE REEL AND REFILL

FEATURES

- Designed to withstand job site conditions
- Built with Kevlar®, stronger than standard lines
- Bold, clear, definitive lines
- 6:1 gear ratio for faster rewind
- Strongest line on the market
- Chalk Included



Product code	Barcode	Size	Inner Qty	Outer Qty
OX-P506302	9341231050404	100ft / 30m	12	36



Layout Tools

TRADE HEAVY DUTY THIN CHALK LINE



FEATURES

- Improved Handle Design
- 8 strand
- Speed of Wind 3.5:1 gear drive for faster rewind of line
- Locking Mechanism

Product code	Barcode	Size	Inner Qty	Outer Qty
OX-T020831	9341231039300	100ft / 30m	8	64

TRADE CHALK REEL/CHALK BUNDLE



FEATURES

- Improved Handle Design
- 8 strand
- Speed of Wind 3.5:1 gear drive for faster rewind of line
- Locking Mechanism
- Chalk Included

Product code	Barcode	Size	Inner Qty	Outer Qty
OX-T020831-COMBO	9341231039225	100ft / 30m	6	48

PRO HEAVY DUTY THICK CHALK LINE



FEATURES

- Improved Handle Design
- 8 strand
- Speed of Wind - 6:1 gear drive for faster rewind of line
- Locking Mechanism

Product code	Barcode	Size	Inner Qty	Outer Qty
OX-P027731	9341231006142	100ft / 30m	8	64

PRO CHALK REEL/CHALK BUNDLE



FEATURES

- Improved Handle Design
- 8 strand Speed of Wind - 6:1 gear
- Drive for faster rewind of line
- Locking Mechanism
- Chalk Included

Product code	Barcode	Size	Inner Qty	Outer Qty
OX-P027731-COMBO	9341231039218	100ft / 30m	6	48



TRADE LINE MARKING CHALK

FEATURES

- Contractor Grade
- High Visibility
- Long Lasting

Product code	Barcode	Size	Inner Qty	Outer Qty
OX-T025007	9341231025662	225g/8oz - Red	6	60
OX-T025008	9341231025679	225g/8oz - White	6	60
OX-T025009	9341231025686	225g/8oz - Blue	6	60
OX-T025010	9341231025693	225g/8oz - Yellow	6	60
OX-T025013	9341231025723	1kg/35oz - Blue	4	24
OX-T025014	9341231025730	1kg/35oz - Red	4	24



PRO DUST-OFF MARKING CHALK REFILL

FEATURES

- Application: indoor remodelling & short term applications
- Permanence: marking for up to 24hrs
- Easy to remove, will not stain surfaces

Product code	Barcode	Size	Inner Qty	Outer Qty
OX-P025922	5060242337963	113g / 4oz - Blue	12	96
OX-P025722	5060530358779	226g / 8oz - Blue	9	72
OX-P025924	5060530358816	113g / 4oz - White	12	96
OX-P025724	5060530358786	226g / 8oz - White	9	72



PRO STANDARD MARKING CHALK

FEATURES

- Application: indoor/outdoor layout
- Permanence: weatherproof up to 1 week
- Ideal for general use on most jobsite materials

Product code	Barcode	Size	Inner Qty	Outer Qty
OX-P025901	5060242337956	113g / 4oz - Red	12	96
OX-P025701	5060242337895	226g / 8oz - Red	9	72
OX-P025902	5060242337963	113g / 4oz - Blue	12	96
OX-P025702	5060242337901	226g / 8oz - Blue	9	72



PRO PERMANENT MARKING CHALK REFILL

FEATURES

- Application: outdoor & long term
- Permanence: waterproof and weatherproof for up to 2 months
- Permanent chalk will stain surfaces

Product code	Barcode	Size	Inner Qty	Outer Qty
OX-P025945	5060530358823	113g / 4oz - Black	12	96
OX-P025745	5060530358793	226g / 8oz - Black	9	72





Layout Tools

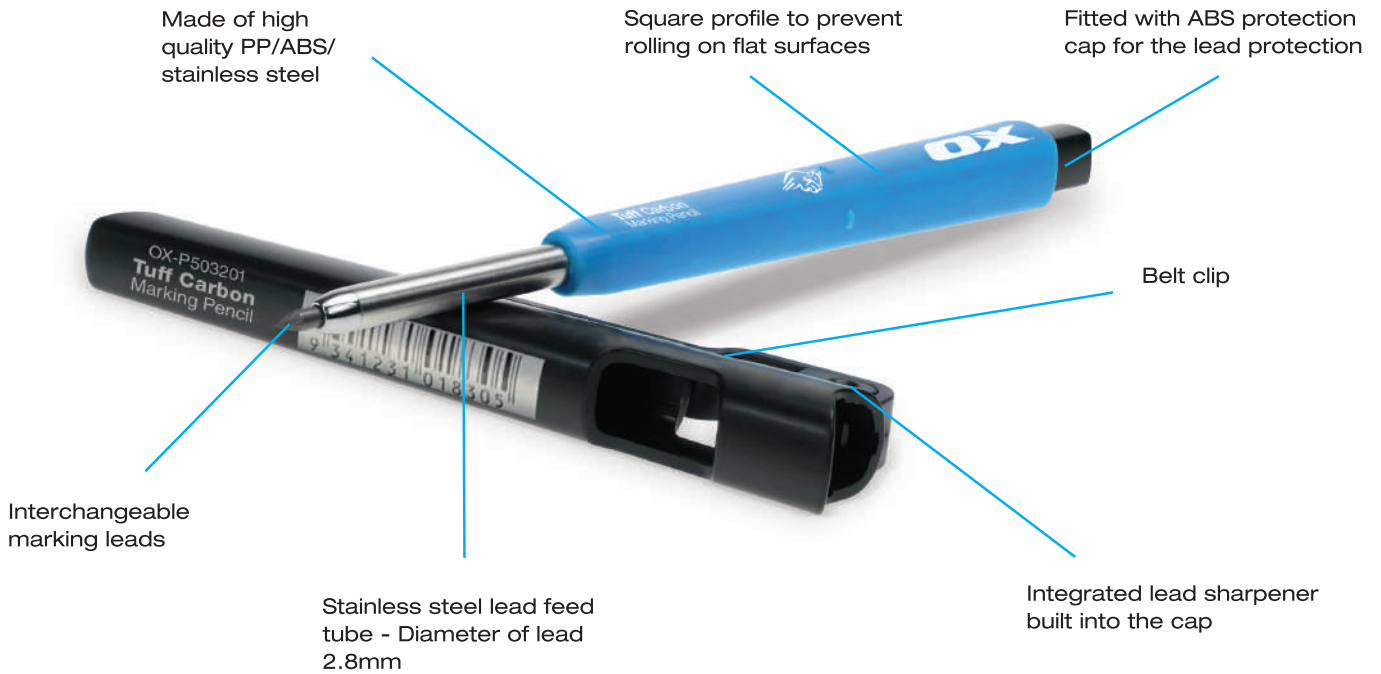

WRITES ON MOST SURFACES



PRO TUFF CARBON MARKING PENCIL



FEATURES

- Belt clip
- Long life automatic marking pencil - automatic lead feed
- Made of high quality PP/ABS/stainless steel
- Fitted with ABS protection cap for the lead protection
- Stainless steel lead feed tube - diameter of lead 2.8mm
- Integrated lead sharpener built into the cap



Product code	Barcode	Size	Inner Qty	Outer Qty
OX-P503201	9341231018305	15mm	10	100



TUFF CARBON MARKING PENCIL DISPLAY PACK

FEATURES

- 24x Tuff Carbon Marking Pencils
- 5x Basic Colour & Graphite Leads (10pk)
- 5x Graphite Leads (10pk)
- 5x Tiling Leads (10pk)



Product code	Barcode	Inner Qty	Outer Qty
OX-P433401	9341231045714	1	25

PRO TUFF CARBON - MARKING PENCIL VALUE PACK

FEATURES

- Lead sharpener built into the cap
- Writes on most surfaces
- 4 Leads included



Product code	Barcode	Size	Inner Qty	Outer Qty
OX-P503210	9341231018336	15mm	10	120

PRO TUFF CARBON LEADS

FEATURES

- Refills - 10 Leads
- For all surfaces
- Damp wipeable

Product code	Barcode	Colours / Qty	Inner Qty	Outer Qty
OX-P503202	9341231018312	10 Multi Leads (3 Basic, 3 Color, 5 Graphite)	10	100
OX-P503203	9341231018329	10 Graphite Leads	10	100
OX-P503204	9341231044380	10 Tile Leads	10	100



Woodworking Tools

“With a crew that uses OX for almost everything, it shows that we believe in the brand and the quality of tools we are using. The quality of their woodworking tools stands out, from their heavy-duty wood chisels to their door clamps and the Heavy Duty Bar Clamps are a game-changer for us enhancing efficiency on the job site and ultimately pushing our overall performance to that next level!”

Andrew Head | EST Building

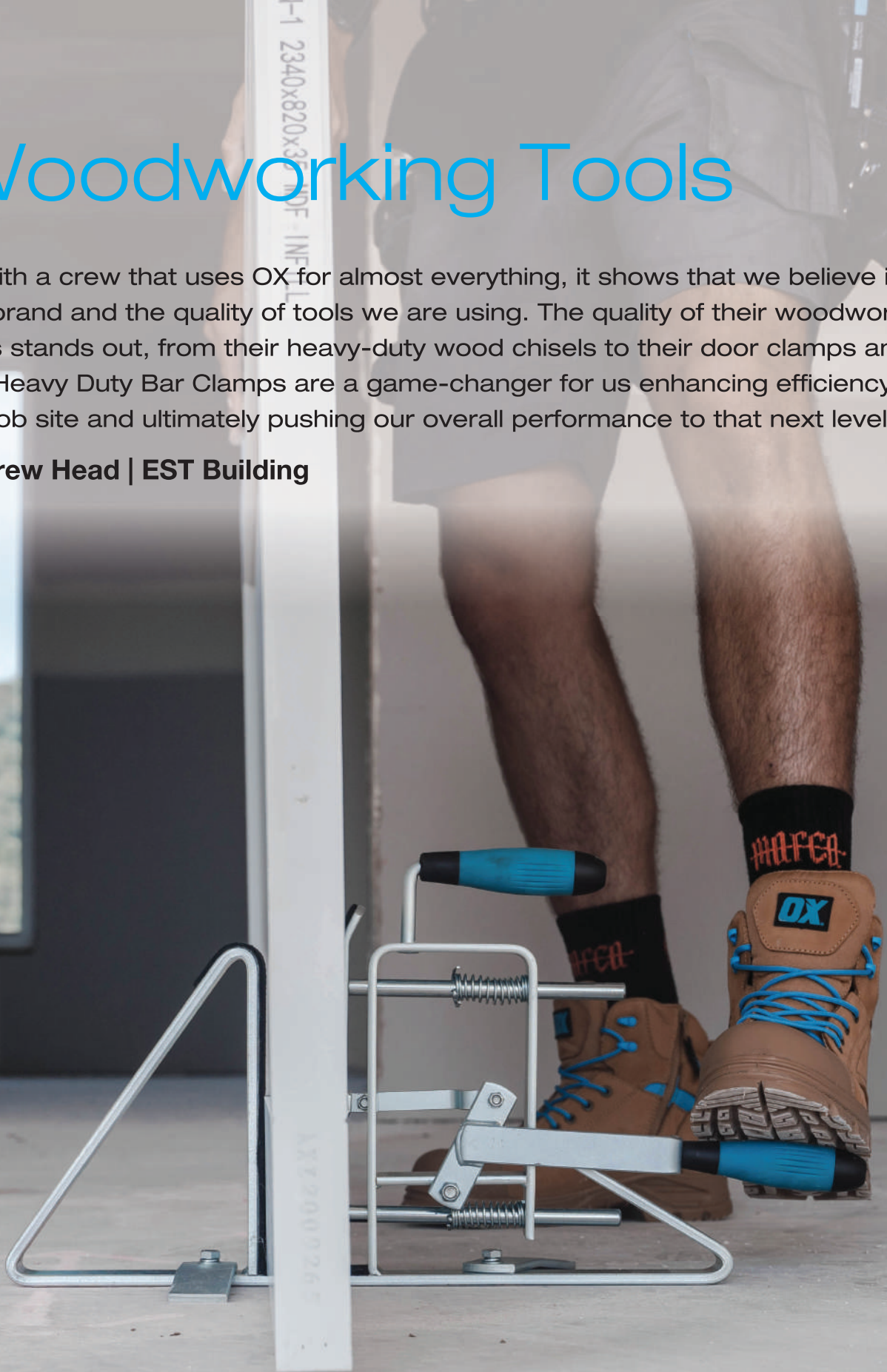



SAVE
 **15** MINS
 PER
DOOR

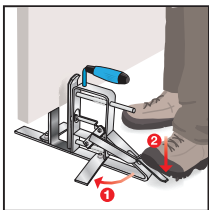
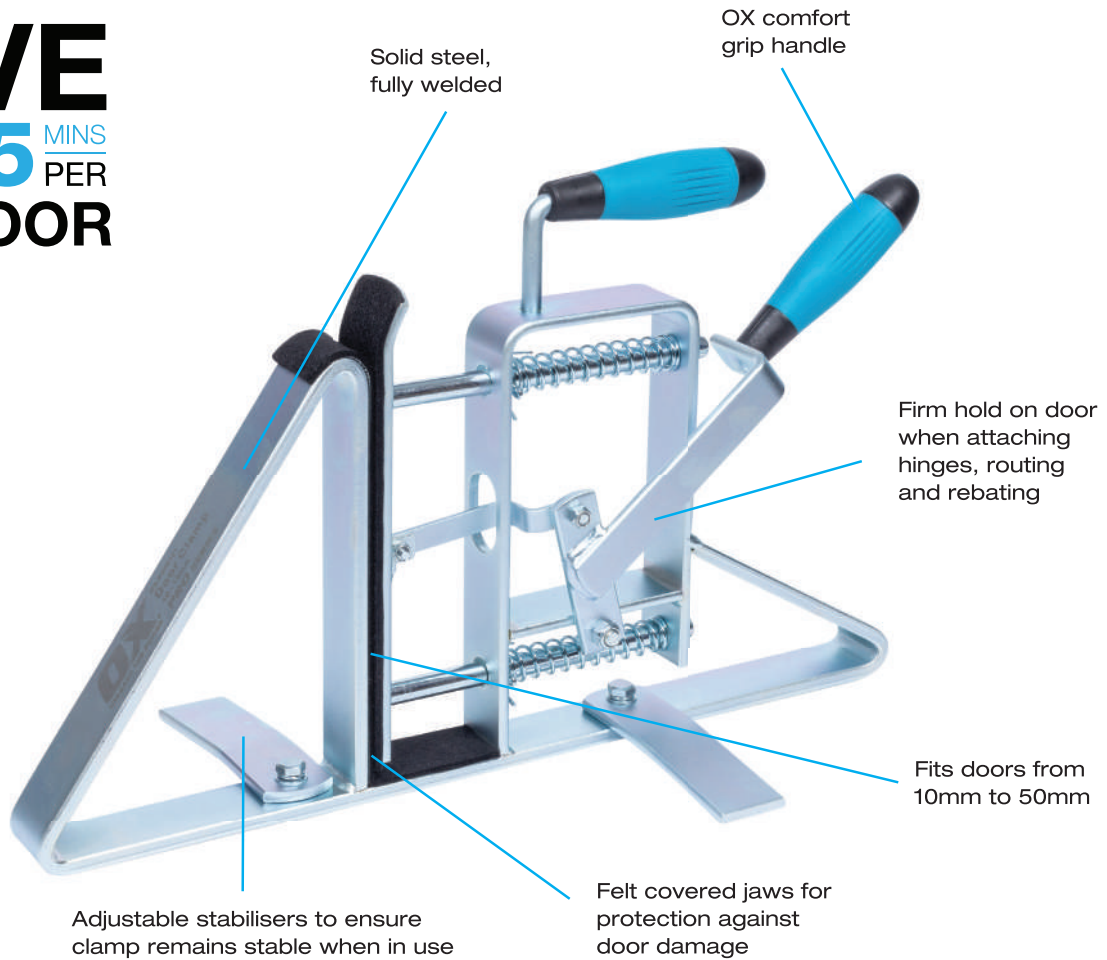

1. Place on floor and spread support feet
2. Open clamp using foot pedal

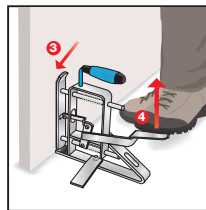

3. Insert Door
4. Release foot from pedal



5. Complete work on door

PRO SOLID STEEL DOOR CLAMP

FEATURES

- Solid steel, fully welded
- Holds door during; attaching hinges, routing, hanging, rebating
- Comfortable soft grip handles
- Felt covered jaws for protection against door damage
- Fits all doors - from 10mm - 50mm



Product code	Barcode	Size	Inner Qty	Outer Qty
OX-P200101	9341231001994	490mm x 300mm	3	6



Woodworking Tools

ULTIMATE DOOR CLAMP



FEATURES

- Heavy duty solid steel large door clamp
- Door holding capacity 10-65mm (fire doors)
- Ideal for attaching hinges, routing, hanging and rebating work
- Felt covered jaws for added door protection
- Calibrated springs for easy clamping
- Welded foot pedal for ease of clamping and unclamping door
- Duragrip handles for added comfort

Product code	Barcode	Size	Inner Qty	Outer Qty
OX-P200102	9341231018411	490mm x 300mm	1	3

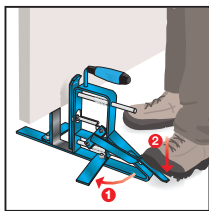

1. Place on floor and spread support feet
2. Open clamp using foot pedal

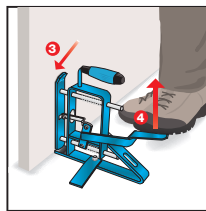

3. Insert Door
4. Release foot from pedal



5. Complete work on door

PRO MINI BAR CLAMP TWIN PACK



FEATURES

- 70kg clamping force gets the job done
- Manufactured using engineering grade plastic for strength and lightweight
- "Long Leverage Design" ensures high pressure clamp force
- Converts easily from a clamp to spreader

Product code	Barcode	Size	Inner Qty	Outer Qty
OX-P203306	9341231039171	150mm / 6"	1	6
OX-P203312	9341231039188	300mm / 12"	1	6



Extended cushions to ensure maximum grip on surfaces

300Kg clamping force

Induction hardened rail for improved strength and durability

Strong engineered ABS Plastic

Can be quickly converted to spreader

Long leverage design for reaching high pressure faster

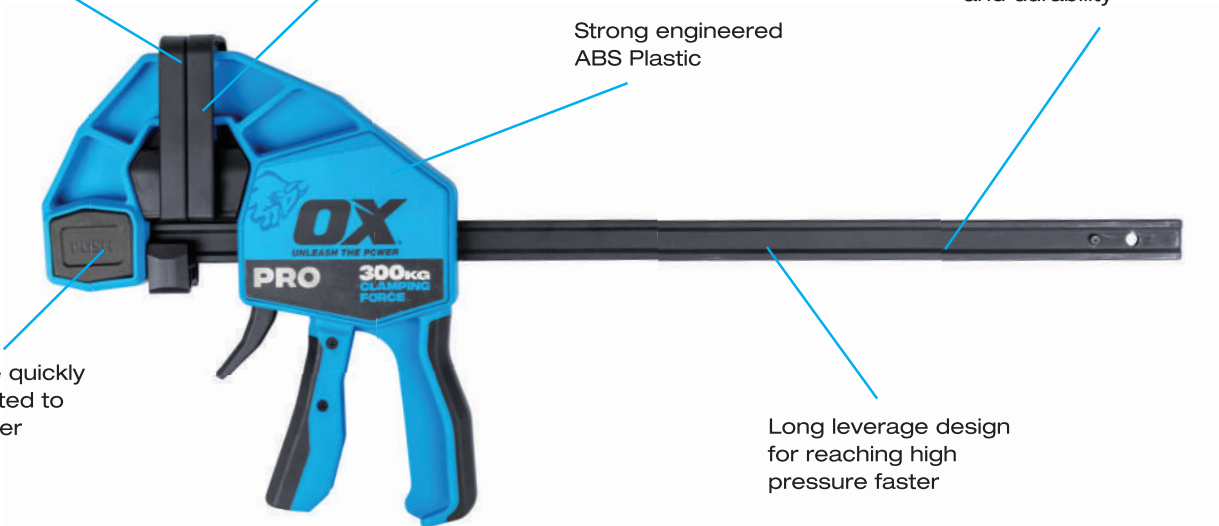

300kg CLAMPING FORCE

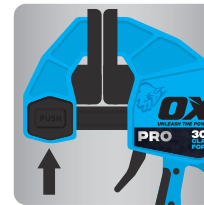

PRO HEAVY DUTY BAR CLAMP

FEATURES

- 300Kg clamping force
- Strong engineered ABS plastic
- Induction hardened rail for improved strength and durability
- Long leverage design for reaching high pressure faster
- Can be quickly converted to spreader
- Optional version with extended cushions



New

Product code	Barcode	Size	Inner Qty	Outer Qty
OX-P203530	9341231051869	300mm	1	6
OX-P203545	9341231055775	450mm	1	6
OX-P203560	9341231051876	600mm	1	6
OX-P203590	9341231051883	900mm	1	6

Replacement Clamp Pads

- Suits OX Heavy Duty Bar Clamps

Product Code	Barcode	Description	Inner Qty	Outer Qty
OX-P203502	9341231055836	Replacement Pads - 2pcs	1	6



Woodworking Tools

PRO HEAVY DUTY WOOD CHISEL



FEATURES

- Forged Steel Core - Superior Strength & Durability
- High Quality Hardened Steel Blade Giving Sustained Performance And Edge Retention
- Extra Large Strike Cap To Withstand Hammer Strikes And Can Be Hit From Multiple Angles
- Split-Proof Acetate Handle Designed Tough To Last

Product code	Barcode	Size	Inner Qty	Outer Qty
OX-P371106	5060530352203	6mm	6	36
OX-P371113	5060530352227	13mm	6	36
OX-P371116	5060530352234	16mm	6	36
OX-P371119	5060530352241	19mm	6	36
OX-P371125	5060530352265	25mm	6	36
OX-P371132	5060530352272	32mm	6	36
OX-P371138	5060530352289	38mm	6	36

PRO 3 PC CHISEL SET



FEATURES

- Forged steel core for superior strength and durability
- Split-proof acetate handles
- High quality hardened steel blade
- Includes 13mm, 19mm and 25mm chisels

Professional 3 piece set of high-quality pro wood chisels.

Product code	Barcode	Sizes	Inner Qty	Outer Qty
OX-P370903-TT	9341231018527	13mm, 19mm and 25mm	6	24

PRO 5 PC CHISEL SET



FEATURES

- Forged steel core for superior strength and durability
- Split-proof acetate handles
- High quality hardened steel blade
- Includes 16mm, 19mm, 25mm, 32mm and 38mm chisels

Professional 5 piece set of high-quality pro wood chisels in a high quality storage case.

Product code	Barcode	Sizes	Inner Qty	Outer Qty
OX-P370905	9341231018534	16mm, 19mm, 25mm, 32mm and 38mm	4	8



PRO WOOD CHISEL SET

FEATURES

- Metal striking cap
- Steel shaft for ultimate strength
- OXGRIP handle for total control
- Special hardened chrome vanadium
- Comes with heavy duty plastic carry case



Product code	Barcode	Size	Inner Qty	Outer Qty
OX-P370105	5060242333644	6, 13, 19, 25 & 32mm	5	10

TRADE CARPENTER'S PENCIL - 10 PK

FEATURES

- Traditional shape chamfered rectangle
- Ideal for marking saw cuts
- High quality lead
- FREE sharpener included

Product code	Barcode	Type	Inner Qty	Outer Qty
OX-T022910	5060135479916	Red / Medium	12	48
OX-T023010	9341231035012	Green / Hard	12	48

* Free counter display when you purchase 12 packs



TRADE CARPENTER'S PENCILS - 72 PK

FEATURES

- Traditional shape chamfered rectangle
- Ideal for marking saw cuts
- High quality lead

Product code	Barcode	Type	Inner Qty	Outer Qty
OX-T022972	5060135479947	Red / Medium	1	4
OX-T023072	9341231025808	Green / Hard	4	8



Cutting Tools

“Over the years we’ve found that OX hand tools are just at that next level above a lot of the other brands out there. We use a wide range of products from the Pro handsaw to the utility knives, snips and now their new masonry saw which is a game-changer when cutting Hebel panels!”

Mitch Coslovich | A&M Landscaping





TRADE SNAP OFF KNIFE - 18MM

FEATURES

- 18mm Snap off blade
- Auto lock feature
- Rubber grip
- Removable end cap to use to snap blades
- Display box of 24pcs



Product code	Barcode	Size	Inner Qty	Outer Qty
OX-T224018-24	19341231016032	3.2 x 8 x 21 cm	1	4

TRADE SNAP OFF KNIFE COMBO PACK

FEATURES

- Reinforced Twist lock for extra strength
- SK5 Type coated blade that stay sharp for longer
- OXGrip TPR body



Product code	Barcode	Size	Inner Qty	Outer Qty
OX-P224625	9341231045356	25mm	6	48

PRO SNAP OFF BLADES - 10 PACK

FEATURES

- SK5 coated blades for maximum sharpness and durability
- 7 snap-off sections for constant sharpness and long life



Product code	Barcode	Size	Inner Qty	Outer Qty
OX-P224518	9341231045325	18mm	20	80
OX-P224525	9341231045332	25mm	20	80

TRADE RETRACTABLE UTILITY KNIFE

FEATURES

- Ergonomic body shape for comfort during long periods of use
- Tough metal construction
- Soft grip insert for added grip



Product code	Barcode	Size	Inner Qty	Outer Qty
OX-T224101	5060530353132	-	12	48



Cutting Tools

TRADE TWIN PACK UTILITY KNIVES



FEATURES

- 1 pc retractable utility knife (metal casing)
- TPR grips for added comfort
- 1 pc lock back knife with quick change blade function
- Foldable design

Product code	Barcode	Size	Inner Qty	Outer Qty
OX-T432602	9341231042997	-	6	24

PRO SOFT GRIP UTILITY KNIFE



FEATURES

- Sleek “flipout” blade storage cartridge in the back of the handle for extra blades
- Quick blade change – “push the button”
- Ergonomic grip for ease of use
- Dual cutting position

Product code	Barcode	Size	Inner Qty	Outer Qty
OX-P220801	9341231032370	-	12	120

PRO HEAVY DUTY FIXED BLADE FOLDING KNIFE



FEATURES

- Ultra sharp steel blades
- Tool free blade change
- Quick fold action
- Strong lightweight construction
- Ergonomical design handle
- Notched thumb rest for enhanced grip
- Sturdy belt hook on reverse
- Built in notch for stripping wire and straps
- Lanyard eyelet for tethering

Product code	Barcode	Size	Inner Qty	Outer Qty
OX-P224301	5060530357390	-	8	64



PRO HEAVY DUTY SK5 TYPE KNIFE BLADES

FEATURES

- SK5 type coated blades for maximum sharpness and durability
- Reversible for longer life and use

Product code	Barcode	Qty	Inner Qty	Outer Qty
OX-P221810	9341231050190	10 pack	36	216
OX-P221905	9341231050206	50 pack	12	48

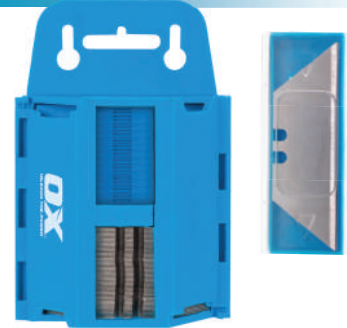

TRADE FIBRO CUTTER

FEATURES

- Steel handles
- Easy to use
- Clean cut

Product code	Barcode	Capacity	Inner Qty	Outer Qty
OX-T230401	9341231013010	3/8" / 10mm	4	12

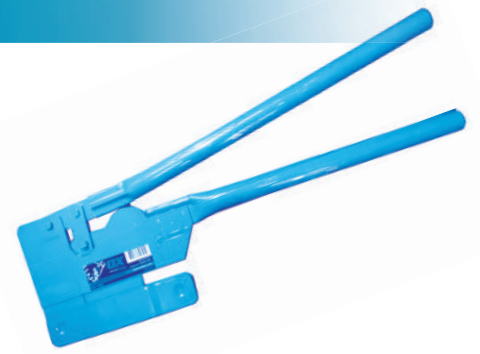

PRO AVIATION SNIPS

FEATURES

- Heat treated alloy jaws
- Rated to cut HRC49
- Max cut 1.5mm mild steel / 0.9 stainless steel

Product code	Barcode	Cut Direction	Inner Qty	Outer Qty
OX-P231001	9341231032448	Left (Red)	4	12
OX-P231002	9341231032455	Right (Green)	4	12
OX-P231003	9341231032462	Straight (Yellow)	4	12



TRADE JAB SAW AND HOLSTER PACK

FEATURES

- Supplied with protective holster for safety when not in use
- Hardened & tempered steel blade for increased life
- 8 Teeth per inch
- Non-slip ergonomic handle
- Excellent for wood, plastic & drywall

Product code	Barcode	Size	Inner Qty	Outer Qty
OX-T131516	5060242338717	6.5" / 165mm	12	36





EASY START

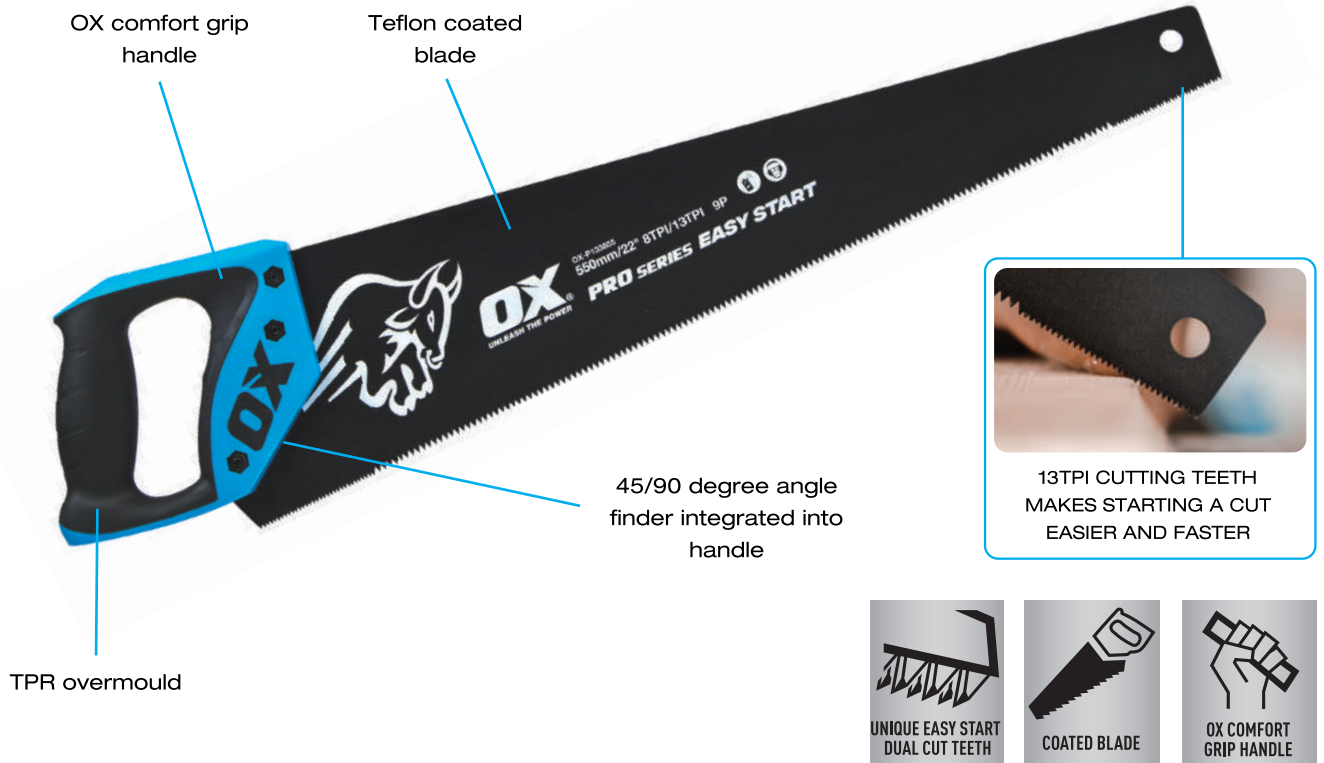

PRO EASY START HANDSAW



FEATURES

- Teflon Coated Blade (reduces friction/increased cutting efficiency)
- Easy start feature: 8TPI / 13TPI easy start up in soft timber
- 45/90 degree angle finder integrated into handle
- TPR Overmould
- OX comfort grip handle
- 550mm Length

Product code	Barcode	Size	Inner Qty	Outer Qty
OX-P133855	9341231044984	550mm	12	36

TRADE HAND SAW



FEATURES

- 500mm/20" Length
- Dual angle, 8tpi teeth for superior cutting performance
- High quality 65MN steel blade
- OX ergo fit handle

Product code	Barcode	Size	Inner Qty	Outer Qty
OX-T130950	9341231016646	500mm	10	40



PRO HAND SAW

FEATURES

- 550mm Length
- Dual Angle 8T/9P Teeth
- Re-usable Blade Protector
- OX Comfort Grip handle



Product code	Barcode	Size	Inner Qty	Outer Qty
OX-P291355	9341231039072	550mm	10	40

PRO MASONRY SAW

FEATURES

- 750mm carbide tipped
- 34 tungsten carbide tipped teeth
- Suitable for lightweight concrete



Product code	Barcode	Size	Inner Qty	Outer Qty
OX-P133034	9341231020209	750mm	2	6

PRO HIGH TENSION 12" (300MM) HACKSAW

FEATURES

- Quick change blade design
- Bi-grip rubber handle
- Blade in either 45° / 90° cut position
- No tools needed to change blade



Product code	Barcode	Size	Inner Qty	Outer Qty
OX-P130730	9341231001062	12" / 300mm	4	16

Plumbing & Electrical Tools

“Good quality products are something every plumber looks for, as well as products that are backed by the manufacture. OX Tools is my go-to as they feel heavy duty. After working with a variety of different brands over the years it's nice to have tools that are reliable, something you can throw around and not worry about getting damaged. They also have a great range of plumbing tools tailored to all different types of plumbing.”

James Mansell | Mansell Plumbing





POLYZIP™ FLEX

INNOVATIVE

Efficient and precise
leaving zero pipe
deformation

Spare blade and
safety insert
included

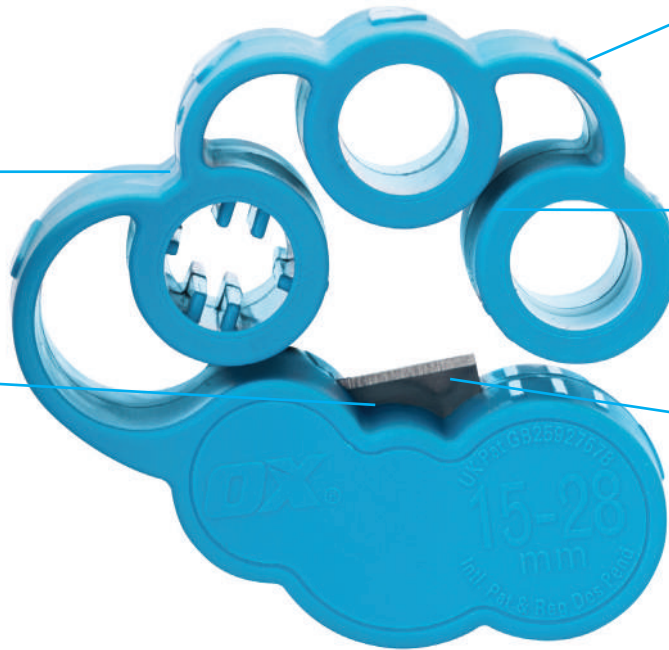

Patented flex
technology for multi
diameter cutting

Zero swarf

Quick change
stainless blade
(reversible dual life)



PRO POLYZIP™ FLEX PIPE CUTTERS - C1 & C2

FEATURES

- Patented flex technology for multi diameter cutting
- Perfect for most popular plumbing pipes and electrical conduits including most flexible conduits
- Ultra-Square cut
- Efficient and precise leaving zero pipe deformation
- Spare blade and safety insert included
- Quick change stainless blade (reversible dual life)
- Zero swarf



New



Product code	Barcode	Size	Inner Qty	Outer Qty
OX-P563328	5060530358755	(C1) 15 - 28mm	3	36
OX-P563355	5060530358762	(C2) 25 - 55mm	3	36

Pro PolyZip Replacement Blade Pack- 3 Pack

Product code	Barcode	Size	Inner Qty	Outer Qty
OX-P562701	5060530353491	3 Pack	10	20

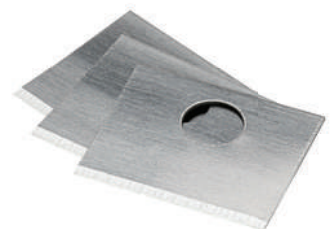



Plumbing & Electrical Tools

PRO ADJUSTABLE TUBE CUTTER



FEATURES

- Heavy duty telescopic tube cutter
- Smooth and accurate telescopic adjustment
- Cuts tubes from 6 - 35mm
- Deburring attachment for removing swarf
- Cuts copper, brass, aluminium and thin walled steel tubes

Product code	Barcode	Size	Inner Qty	Outer Qty
OX-P448635	5060359914668	3 - 35mm	1	25



Pro Replacement Cutting Wheel for Adjustable Pipe Cutter - (2 Pack)

Product code	Barcode	Size	Inner Qty	Outer Qty
OX-P560302	5060359919168	-	2	12

PRO PVC PIPE CUTTER 16 - 42MM



FEATURES

- V Shape blade for immediate penetration.
- Exceptionally sharp stainless steel blade.
- Cuts through any MUPVC/PVC pipe effortlessly without kinking or shattering
- Replacement blade available(OX-P449701)

Product code	Barcode	Size	Inner Qty	Outer Qty
OX-P449542	5060359915795	16 - 42MM	12	36



■ PVC Pipe Cutter Replacement Blade

Product code	Barcode	Size	Inner Qty	Outer Qty
OX-P449701	5060359915993	200mm	1	24

TRADE PVC PIPE CUTTER



FEATURES

- Aluminium blade
- Cuts through any PVC pipe effortlessly
- Exceptionally sharp stainless-steel blade
- One handed locking mechanism

Product code	Barcode	Size	Inner Qty	Outer Qty
OX-T563801	5060530359769	-	12	36



PRO ULTRA-WIDE JAW ADJUSTABLE WRENCH

FEATURES

- Ultra wide jaw opening
- Very slim head for access into tight spaces
- Precision hardened for durability
- Soft grip handle
- Measurement scale on jaw

Product code	Barcode	Size	Inner Qty	Outer Qty
OX-P324606	5060242337512	6" / 152mm	6	12
OX-P324608	5060242337529	8" / 200mm	4	12
OX-P324610	5060242337536	10" / 250mm	4	12
OX-P324612	5060242337543	12" / 300mm	4	12

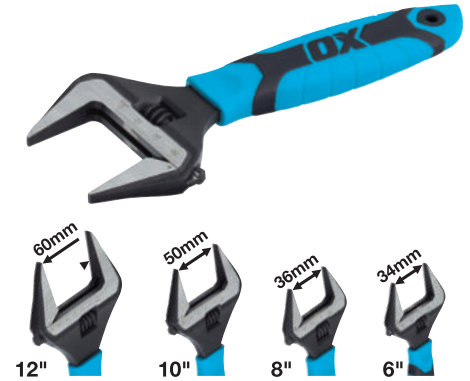

PRO SLIM-JAW ADJUSTABLE WRENCH

FEATURES

- Ultra slim head for easy accessibility in the most confined spaces
- Double ended with a fixed jaw at one end for nuts, bars, screws etc.
- Precision hardened construction
- Measurement scale on jaw
- Special coating to eliminate rusting

Product code	Barcode	Size	Inner Qty	Outer Qty
OX-P560208	5060359918932	8" / 200mm	1	6



PRO ADJUSTABLE STUBBY WRENCH EXTRA WIDE JAW

FEATURES

- short handled wrench for access in restricted spaces
- 0 - 53mm ultra wide opening slim jaws
- Dipped handle for comfort
- Heavy duty build for long life

Product code	Barcode	Size	Inner Qty	Outer Qty
OX-P560507	5060530350735	7" / 180mm	6	36



PRO HEAVY DUTY SELF LOCKING WRENCH

FEATURES

- OX strength self locking grip
- Grips stainless steel tubes
- Super lightweight aluminium handle

Product code	Barcode	Size / Jaw Size	Inner Qty	Outer Qty
OX-P560110	5060359918789	10" / 250mm, 34mm	1	12





Plumbing & Electrical Tools

PRO MULTI ANGLE WRENCH



FEATURES

- 180° Quick action adjustable handle
- 10 Individual lockable handle positions
- Fully adjustable jaw up to 53mm
- Lightweight aluminium handle for strain free all-day use.
- Perfect for use in restricted areas

Product code	Barcode	Size	Inner Qty	Outer Qty
OX-P560610	5060530352173	10" / 250mm	1	6

TRADE ADJUSTABLE BASIN WRENCH



FEATURES

- Telescopic basin nut wrench
- Reversible jaw for easy access
- 4 Adjustment sizes
- 10 To 32mm jaw capacity

Product code	Barcode	Size	Inner Qty	Outer Qty
OX-T563401	5060530358830	10 - 32 mm	1	15

PRO MAX LEVERAGE STRAIGHT JAW GRIPS



FEATURES

- Push button release for super fast and accurate adjustment
- Ultimate force distribution from jaws to handle providing incredible grip

Product code	Barcode	Size	Inner Qty	Outer Qty
OX-P562525	5060530353095	10" / 250mm	1	6

PRO STILLSON WRENCH



FEATURES

- Forged from high quality steel
- Deeply grooved jaws for instant grip and ratcheting action
- Hardened and tempered steel adjustment nut

Product code	Barcode	Size	Inner Qty	Outer Qty
OX-P441812	5060359914569	12" / 300mm	1	6
OX-P441814	5060359914576	14" / 350mm	1	6



PRO AUTOMATIC WATERPUMP PLIERS

FEATURES

- Double dipped handle for comfort
- Tough chrome vanadium steel
- Automatic waterpump pliers for fast one hand size adjustment

Product code	Barcode	Size	Inner Qty	Outer Qty
OX-P326010	5060359914521	250mm / 10"	6	48
OX-P326012	5060359914538	300mm / 12"	6	48



TRADE LOCKING PLIERS

FEATURES

- Forged and machined jaws for ultra strong grip
- Quick jaw release lever for ease of opening
- Soft grip dipped handle for greater comfort

Product code	Barcode	Size	Inner Qty	Outer Qty
OX-T563518	5060530359714	7" / 180mm	10	40
OX-T563525	5060530359721	9" / 230mm	10	40



PRO LOCKING PLIERS

FEATURES

- Forged and machined jaws for ultra strong grip
- Ideal for gripping pipes and bolts
- Chrome plated durable body
- Quick jaw release lever for ease of opening
- Soft grip dipped for greater comfort

Product code	Barcode	Size	Inner Qty	Outer Qty
OX-P449323	5060359915412	9" / 230mm	1	5



Site Tools & Accessories

“OX has a great range when it comes to site tools, our guys use the OX shovels and floor scrapers to clean up all our mess after each job. I'd have to say that the tools are built tough and are consistently reliable.”

Matt Jamieson | Render X





TRADE SPOT MARKING PAINT - 12 PACK

FEATURES

- 12 Pack
- Lead free
- 350g aerosol can
- Professional quality hi-visibility colours
- Use on asphalt, dirt, concrete & timber
- Unique trigger cap for easy, safe, inverted marking
- Ideal for marking out roadworks, building sites, grass and sporting areas



Product code	Barcode	Size / Colour	Inner Qty	Outer Qty
OX-T022501	9341231000553	350g / Blue	1	12
OX-T022502	9341231000560	350g / Fluro Green	1	12
OX-T022503	9341231000577	350g / Fluro Orange	1	12
OX-T022504	9341231000584	350g / Fluro Pink	1	12
OX-T022505	9341231000591	350g / Fluro Red	1	12
OX-T022506	9341231000607	350g / White	1	12
OX-T022507	9341231000614	350g / Fluro Yellow	1	12

12
BOX



TRADE RATCHET TIE DOWNS - 25MM WIDE 250KGLC

FEATURES

- Heavy duty ratchet tie down straps
- 25mm x 4m blue polyester webbing
- 250kg lashing capacity and
- 600kg breaking strength
- Vinyl coated 's' hooks for added protection
- 4 pack

Product code	Barcode	Lashing Capacity	Inner Qty	Outer Qty
OX-T201504	9341231055478	250kg	1	5

New



PRO 50MM RATCHET TIE DOWN - SINGLE

FEATURES

- Light weight
- Double locking mechanism
- 2 protective sleeves
- Complies with AS/NZS
- 50mm x 9m blue polyester strap
- Lashing capacity 2500kg
- Breaking strength 5000kg
- Complies with AS/NZS

Product code	Barcode	Lashing Capacity	Inner Qty	Outer Qty
OX-P201109	9341231011078	2500kg	1	5



PRO 35MM RATCHET TIE DOWN - SINGLE

FEATURES

- Light weight
- Double locking mechanism
- 2 protective sleeves
- Complies with AS/NZS
- 35mm x 9m blue polyester strap
- Lashing capacity 1250kg
- Breaking strength 2500kg
- Complies with AS/NZS

Product code	Barcode	Lashing Capacity	Inner Qty	Outer Qty
OX-P201306	9341231019241	1250kg	1	5





Site Tools & Accessories

PRO DUAL THRUST CAULKING GUN



FEATURES

- Patented Quick Switch Dual Thrust Ratio 12:1 & 24:1
- Suits 600mm bulk cartridges
- Patented no gaps trigger design
- Twin Heat Treatment Steel Push Plates & 1.5mm Steel Push Piston
- Glass Fibre impregnated body with TPR handle
- Suitable For Low To High Viscosity Materials



Product code	Barcode	Size	Inner Qty	Outer Qty
OX-P045430	9341231042942	310ml	4	12

PRO DUAL THRUST SEALANT GUN



FEATURES

- Patented Quick Switch Dual Thrust Ratio 12:1 & 24:1
- Glass Fibre impregnated body with TPR handle
- Patented no gaps trigger design
- Patented 360° Barrel Rotary type Anodized Aluminum Barrel
- Patented Quick Fit & Toolless Plunger System (honeycomb design)
- Suitable For Low To High Viscosity Materials



Product code	Barcode	Size	Inner Qty	Outer Qty
OX-P045560	9341231042966	600ml/20oz	4	10

PRO RODLESS CAULK GUN



FEATURES

- Single component applicator
- Unique design rodless gun
- Rivetted & reinforced carriage
- Suitable for narrow space application
- Ergonomic operation design
- Ideal for use with latex & silicone caulks
- Total Length: 340mm



Product code	Barcode	Size	Inner Qty	Outer Qty
OX-P044910	9341231018626	340 mm / 7:1 Thrust Ratio	1	12



PRO CAULKING GUN

FEATURES

- Skeleton frame
- 6mm hex rod with ladder hang hook
- Quick release lever



Product code	Barcode	Size	Inner Qty	Outer Qty
OX-P040109	9341231011719	310ml	12	24

PRO DRIPLESS CAULKING GUN

FEATURES

- Mechanical thrust ratio: 7:1
- Cartridge Size: 310ml
- Zinc alloy handle / Steel trigger
- Steel zinc plated push rod
- Built-in cartridge puncture tool
- LOW to MEDIUM Viscosity



Product code	Barcode	Size	Inner Qty	Outer Qty
OX-P041810	5060359918895	310ml	1	10

PRO TUBULAR SEALANT GUN

FEATURES

- Quick release lever
- Suits 600mm bulk cartridges
- Aluminium tube



Product code	Barcode	Size	Inner Qty	Outer Qty
OX-P040215	9341231007361	600ml	1	10



Site Tools & Accessories

PRO 15" TUBULAR SEALANT GUN



FEATURES

- Quick release lever
- Suits 600mm bulk cartridges
- Aluminium tube

Product code	Barcode	Size	Inner Qty	Outer Qty
BI-P040215	9341231018459	15"	1	10

PRO SPARE SEALANT GUN TIPS - 6 PACK



FEATURES

- Genuine replacement nozzles

Product code	Barcode	Size	Inner Qty	Outer Qty
OX-P049801	9341231011702	6 Pack	12	120

PRO TOUGH XL WIPES (80 PACK)



FEATURES

- 80 wipes per pack
- Heavy duty double sided wipes ideal for aggressive cleaning with one side and smooth wiping and soaking up with the other!
- Extra large wipes - 20% better value
- Anti-bacterial - kills 99.99% of germs!
- Added Aloe Vera - keeps skin healthy
- Double sided - abrasive side & smooth side for dual action
Removes: Oil, Adhesive, Paint, Silicone, Glue, Sealant, Grime, PU Foam, Plaster & Cement

Product code	Barcode	Size	Inner Qty	Outer Qty
OX-P350580	5060359916792	80 Sheets	1	12



TRADE PACK DOWN 800MM SAW HORSES - PAIR

FEATURES

- Saves space in ute/truck and other areas.
- Locking pin
- Lockable legs
- Length 800mm in height
- Solid bamboo benchtop 800mm
- 350kg weight rated

Product code	Barcode	Size	Inner Qty	Outer Qty
OX-T335575	9341231055713	800mm	5	10



PRO 750MM SAW HORSE - PAIR

FEATURES

- Locking pin
- Lockable legs
- Length 750mm in height
- Solid bamboo benchtop 800mm
- Durable and sturdy saw horse set

Product code	Barcode	Size	Inner Qty	Outer Qty
OX-P335675	9341231034466	750mm	5	10



PRO 900MM SAW HORSE - PAIR

FEATURES

- Locking pin
- Lockable legs
- Length 900mm in height
- Solid bamboo benchtop 1000mm
- Durable and sturdy saw horse set

Product code	Barcode	Size	Inner Qty	Outer Qty
OX-P335690	9341231016325	900mm	1	2

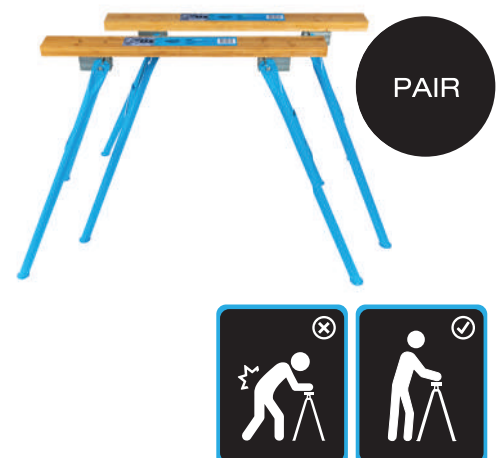



Site Tools & Accessories

TRADE BLUETOOTH LED WORK LIGHT



FEATURES

- Led jobsite worklight with built in bluetooth speaker
- 1400 lumens of visible light
- Rubber overmould bumper and metal grille for fall protection
- Work stand with comfor grip handle
- IP44 rated to protect against dust and water spray

Product code	Barcode	Lumen	Inner Qty	Outer Qty
OX-T310820	9341231019210	1400LM	1	4

PRO BLUETOOTH LED WORK LIGHT



FEATURES

- Strong magnetic 360° rotating base for attaching to steel surfaces with additional screw holes for attaching to timber surfaces
- Tilts forwards and backwards giving the perfect required angle
- Multiple power settings ranging from 500 lumens up to 3000 lumens
- Charges from a standard usb-c charger fitting includes a usb fitting for charging phones and devices

Product code	Barcode	Lumen	Inner Qty	Outer Qty
OX-P311023	9341231044373	2300LM	1	6

TRADE FLOOR SCRAPER

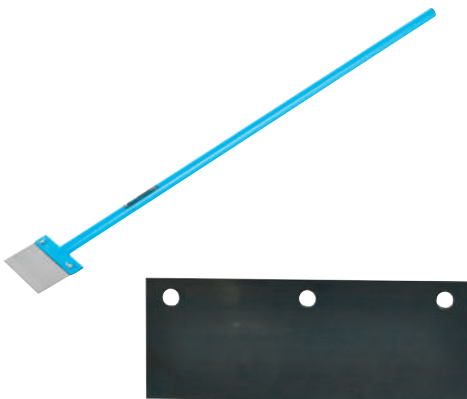

FEATURES

- All steel construction & spring steel blade

Product code	Barcode	Blade Size	Inner Qty	Outer Qty
OX-T050506	9341231050671	6" / 150mm	1	3
OX-T050508	9341231011856	8" / 204mm	1	3
OX-T050512	9341231011863	12" / 300mm	1	3
OX-T050514	9341231033742	14" / 350mm	1	3
OX-T050520	9341231033759	20" / 500mm	1	3

- Replacement spring steel blade

Product code	Barcode	Suits	Inner Qty	Outer Qty
OX-T059406	9341231050688	OX-T050506	10	40
OX-T059408	9341231033766	OX-T050508	10	40
OX-T059412	9341231033773	OX-T050512	10	40
OX-T059414	9341231033780	OX-T050514	10	40



PRO ALL STEEL FLOOR SCRAPER

FEATURES

- All steel construction
- Spring steel blade
- T-Grip handle

Product code	Barcode	Size	Inner Qty	Outer Qty
OX-P050208	9341231001765	8" / 204mm	1	3

204mm Floor Scraper Blade Replacement

Product code	Barcode	Suits	Inner Qty	Outer Qty
OX-P059808	9341231001789	OX-P050208	4	18

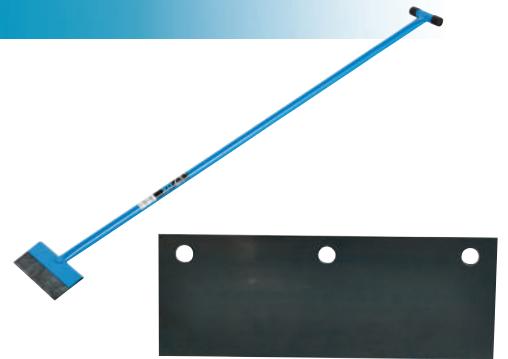

PRO FLOOR SCRAPER

FEATURES

- Spring steel blade
- Braced for extra strength
- All steel head with hardwood handle

Product code	Barcode	Blade Width	Inner Qty	Outer Qty
OX-P050314	9341231013041	14" / 356mm	1	3

Replacement spring steel blade

Product code	Barcode	Suits	Inner Qty	Outer Qty
OX-P059714	9341231021954	OX-P050314	10	40



PRO HEAVY DUTY FLOOR SCRAPER

FEATURES

- All steel construction
- Spring steel blade
- Trapezoid blade
- T-Grip handle

Product code	Barcode	Size	Inner Qty	Outer Qty
OX-P050408	9341231021473	8" / 200mm	1	3

Replacement spring steel blade

Product code	Barcode	Suits	Inner Qty	Outer Qty
OX-P059608	9341231021480	OX-P050408	6	84

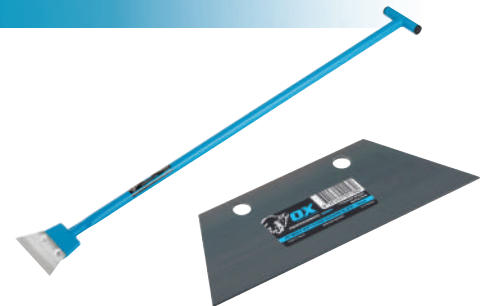

TRADE TRIGGER SPRAYER

FEATURES

- Twist lock pump handle
- Smooth operating trigger
- Ergonomic handles for comfort & control

Product code	Barcode	Size	Inner Qty	Outer Qty
OX-T042005	9341231032240	500ml	5	100
OX-T042010	9341231032257	1000ml	5	50





Site Tools & Accessories

PRO MASONRY BUCKET



FEATURES

- Flexible HDPE material
- Non-marking smooth base
- Safety metal handle

Product code	Barcode	Size	Inner Qty	Outer Qty
OX-P110215	9341231007354	15L	10	20

PRO PLASTIC BUCKET - 10L



FEATURES

- The bucket is made of Low Density Polyethylene (LDPE), which gives it hardness and lightness
- It has reinforcing lateral nerves and reinforced base, inferior brim for easy pouring, galvanized ø4mm metallic handle
- This bucket has a slight conical shape for easy stacking

Product code	Barcode	Size	Inner Qty	Outer Qty
OX-P110610	9341231035715	10L	10	20

PRO RUBBER BUCKET WITH POURING LIP - 15L



FEATURES

- The bucket is made of High grade moulded rubber, which makes it flexible and resistant
- It has reinforcing lateral nerves and reinforced base, pouring beak, interior capacity indication (l)
- Inferior brim for easy pouring, galvanized ø4mm metallic handle
- This bucket has a slight conical shape for easy stacking

Product code	Barcode	Size	Inner Qty	Outer Qty
OX-P110615	9341231034473	15L	10	20

PRO HEAVY DUTY PLASTIC BUCKET - 40L



FEATURES

- The bucket is made of Low Density Polyethylene (LDPE), which gives it hardness and lightness.
- It has Two extremely strong handles for easy handling
- This bucket has a slight conical shape for easy stacking

Product code	Barcode	Size	Inner Qty	Outer Qty
OX-P110640	9341231034435	40L	10	20



TRADE CONCRETTERS SHOVEL - HAMMERTONE

FEATURES

- Length: 1040mm
- 'D' grip handle
- Head size: 250mm x 300mm
- All steel, pressed and welded construction with a hammertone finish

Product code	Barcode	Size	Inner Qty	Outer Qty
OX-T281307	9341231016660	1040mm	4	12



TRADE SQUARE MOUTH SHOVEL

FEATURES

- 'D' grip handle
- All steel, pressed and welded construction
- High visibility blue powder coated
- Head size: 250 x 300mm

Product code	Barcode	Length	Inner Qty	Outer Qty
OX-T280107	9341231000089	1040mm	1	6
OX-T280109	9341231000072	1200mm	1	6



TRADE SQUARE MOUTH SHOVEL - LONG HANDLE

FEATURES

- Long handle - rubber grip
- All steel, pressed and welded construction
- High visibility blue powder coated
- Head size: 250 x 300mm

Product code	Barcode	Length	Inner Qty	Outer Qty
OX-T280212	9341231000096	1500mm	1	6



TRADE POST HOLE SHOVEL

FEATURES

- Post hole shovel for digging deep/narrow holes as well as pits, fencing and shallow trench digging
- Treaded blade allows for easy digging
- 1.2m fiberglass handle (wall thickness of 3mm) with timber reinforcing for strength & durability
- Stainless steel connecting ring (shovel head & handle) used for: concreting, landscaping, gardening & mechanics anti slip handles grips
- 1.6kg overall weight

Product code	Barcode	Length	Inner Qty	Outer Qty
OX-T281601	9341231018107	153 x 19.8 x 3cm	6	24



Tool Storage

“I have just decked myself out with the new black trade leather tool belt and few attachments. They have got it right with the configuration of the pockets and everything seems to sit nicely on your waist. I am loving the blue stitching against the black leather – classy! The boys are using the tool bags also – the tote has taken a beating and hasn’t let us down.”

Andrew Head | EST Building





PRO TOTE BAG

FEATURES

- Extremely tough construction for ultimate durability
- Injected polypropylene hard base
- Waterproof base moulded to fabric
- Heavy-duty steel handle with rubber grip
- Open structure for quick and easy tool access
- Multiple use tool compartments



Product code	Barcode	Size	Inner Qty	Outer Qty
OX-P262618	5060242338618	18"	1	4

PRO TUFF BAG

FEATURES

- Jumbo size tuff bag
- Tough 600D construction with heavy duty webbing, handles and zip
- Integrated castors, handle and detachable shoulder strap



Product code	Barcode	Size	Inner Qty	Outer Qty
OX-P265501	9341231043093	24in x 12in x 13.5in (61cm x 30.5cm x 34cm)	1	3

PRO STORAGE BAG

FEATURES

- 15" Dynamic Nylon storage bag for extreme durability
- Front pouches to hold frequently used tools
- Wide mouth to easily store tools
- Durable should strap for portability
- Reinforced stitching at stress points



Product code	Barcode	Size	Inner Qty	Outer Qty
OX-P262930	9341231019050	15"	5	20



Tool Storage

TRADE BLACK LEATHER CONSTRUCTION APRON 12 POCKET



FEATURES

- Oil Tanned Heavy Duty Split Leather
- Thickness: Heavy 2mm +
- Belt Tunnel Fits up to 3" Wide Belts

Product code	Barcode	Size	Inner Qty	Outer Qty
OX-T265601	9341231043741	12 pocket	4	8

TRADE BLACK LEATHER TOOL POUCH



8
POCKET

FEATURES

- Oil Tanned Heavy Duty Split Leather
- Thickness: Heavy 2mm +
- Belt Tunnel Fits up to 3" Wide Belts

8 POCKET

Product code	Barcode	Size	Inner Qty	Outer Qty
OX-T265603	9341231043765	8 pocket	6	12



6
POCKET

6 POCKET

- Oil Tanned Heavy Duty Split Leather
- Thickness: Heavy 2mm +
- Belt Tunnel Fits up to 3" Wide Belts

Product code	Barcode	Size	Inner Qty	Outer Qty
OX-T265602	9341231043758	6 pocket	6	12

TRADE BLACK LEATHER 2 POCKET NAIL BAG



2
POCKET

FEATURES

- Oil Tanned Heavy Duty Split Leather
- Thickness: Heavy 2mm +
- Belt Tunnel Fits up to 3" Wide Belts

Product code	Barcode	Size	Inner Qty	Outer Qty
OX-T265604	9341231043772	2 pocket	6	18



TRADE BLACK LEATHER CHISEL HOLDER

FEATURES

- Oil Tanned Heavy Duty Split Leather
- Thickness: Heavy 3mm +
- Belt Tunnel Fits up to 3" Wide Belts

1
POCKET



2
POCKET



Product code	Barcode	Size	Inner Qty	Outer Qty
OX-T265703	9341231043802	Single Pocket	8	48
OX-T265704	9341231043819	Double Pocket	8	48

TRADE BLACK LEATHER DUAL CHISEL & NIP HOLDER

FEATURES

- Fits up to 2 chisels and 1 pair of nip cutters
- Heavy duty 3mm thick leather
- Robust riverts for increased durability
- Fits belts up to 2" wide

Product code	Barcode	Inner Qty	Outer Qty
OX-T265711	9341231054419	8	48

New



TRADE BLACK LEATHER DUAL CHISEL & HAMMER HOLDER

FEATURES

- Dual pouch to hold chisels and a hammer
- Heavy duty 3mm thick leather
- Robust riverts for increased durability
- Fits belts up to 2" wide

Product code	Barcode	Inner Qty	Outer Qty
OX-T265713	9341231054433	8	48

New



TRADE BLACK LEATHER NIP HOLDER

FEATURES

- Oil Tanned Heavy Duty Split Leather
- Thickness: Heavy 3mm +
- Belt Tunnel Fits up to 3" Wide Belts

Product code	Barcode	Inner Qty	Outer Qty
OX-T265705	9341231043826	8	48





Tool Storage

TRADE BLACK LEATHER HAMMER HOLDER - FIXED



FEATURES

- Oil Tanned Heavy Duty Split Leather
- Thickness: Heavy 3mm +
- Belt Tunnel Fits up to 3" Wide Belts

Product code	Barcode	Inner Qty	Outer Qty
OX-T265701	9341231043789	8	48

TRADE BLACK LEATHER HAMMER HOLDER - SWIVEL



FEATURES

- Oil Tanned Heavy Duty Split Leather
- Thickness: Heavy 3mm +
- Belt Tunnel Fits up to 3" Wide Belts

Product code	Barcode	Inner Qty	Outer Qty
OX-T265702	9341231043796	8	48

TRADE BLACK LEATHER DRILL HOLDER



FEATURES

- Oil Tanned Heavy Duty Split Leather
- Thickness: Heavy 3mm +
- Belt Tunnel Fits up to 3" Wide Belts

Product code	Barcode	Inner Qty	Outer Qty
OX-T265706	9341231043833	8	32

TRADE BLACK LEATHER TORPEDO LEVEL HOLDER



FEATURES

- Large pouch to securely hold a torpedo level, nips, tin snips, etc.
- Heavy duty 3mm thick leather
- Robust riverts for increased durability
- Fits belts up to 2" wide

Product code	Barcode	Inner Qty	Outer Qty
OX-T265712	9341231054426	8	48



TRADE BLACK LEATHER AIRGUN HOLDER

FEATURES

- Designed to hold hand held power tools including drills, air guns, nail guns, etc.
- Heavy duty 3mm thick leather
- Robust rivets for increased durability
- Fits belts up to 2" wide

Product code	Barcode	Inner Qty	Outer Qty
OX-T265714	9341231054440	8	48

New



TRADE BLACK LEATHER TAPE HOLDER

FEATURES

- Fits FatMax 8 mtrs
- Thickness: Heavy 3mm +
- Belt Tunnel Fits up to 3" Wide Belts

Product code	Barcode	Inner Qty	Outer Qty
OX-T265707	9341231043840	8	48



TRADE BLACK LEATHER TAPE MEASURE CLIP HOLDER

FEATURES

- Slim clip design for ease of use
- Heavy duty 3mm thick leather
- Robust rivets for increased durability
- Fits belts up to 2" wide

Product code	Barcode	Inner Qty	Outer Qty
OX-T265710	9341231050374	8	48

New



TRADE BLACK LEATHER MOBILE PHONE HOLDER

FEATURES

- Heavy Duty Oil Tanned Split Leather

Product code	Barcode	Size	Inner Qty	Outer Qty
OX-T265708	9341231044939	L	8	48
OX-T265709	9341231045011	XL	8	48





Tool Storage

TRADE BLACK LEATHER BELT - 2"



FEATURES

- Heavy Duty Oil Tanned Split Leather
- Thickness: 3mm +

Product code	Barcode	Size	Inner Qty	Outer Qty
OX-T265802	9341231043857	2"	8	32

TRADE PADDED NYLON BACK SUPPORT BELT



FEATURES

- 5" (125mm) padded nylon back support
- With 2" (50mm) leather work belt

Product code	Barcode	Size	Inner Qty	Outer Qty
OX-T265804	9341231043871	5"	8	32

TRADE PADDED NYLON SUSPENDERS



FEATURES

- Tough leather straps and padded nylon for durability and comfort
- Fully adjustable belts including centre chest strap to prevent harness spreading
- 2:1 Strap (2 front/1 rear) to evenly distribute the load over shoulders and back
- Water resistant nylon stitching
- Heavy duty belt clips and loop through belt option also included

Product code	Barcode	Inner Qty	Outer Qty
OX-T267301	9341231050244	-	-



TRADE HEAVY DUTY SUEDE LEATHER

FEATURES

- Quick Release Buckle
- Heavy Duty Suede Leather; Rivet Reinforced At Stress Points
- Double Row Stitching For Added Strength And Durability
- 2" Wide Heavy Duty Webbing Belt With A Quick Release Plastic Buckle

2 POCKET

- One Large Wide Mouth Main Pocket; One Medium Size Front Pocket

Product code	Barcode	Description	Inner Qty	Outer Qty
OX-T265102	9341231018220	2 Pocket Nail Bag	6	24



2
POCKET

6 POCKET

- Two Large Wide Mouth Main Pockets; One Medium Size Front Pocket
- 3 Small Tool/Pencil Pockets; 1 Fixed Type Metal Hammer Holders
- Leather Pocket To Hold Most Common/Popular Tape Measures

Product code	Barcode	Description	Inner Qty	Outer Qty
OX-T265301	9341231018244	6 Pocket Tool Belt	6	24



6
POCKET

10 POCKET

- Two Large Wide Mouth Main Pockets; Two Medium Size Front Pockets; 6 Small Tool/Pencil Pockets; 2 Fixed Type Metal Hammer Holders

Product code	Barcode	Description	Inner Qty	Outer Qty
OX-T265202	9341231018237	10 Pocket Tool Belt	6	24



10
POCKET

Safety Equipment

“OX safety range is great offering all the PPE essentials safety's, earplugs, dust masks and even work boots. I am on my feet all day every day and have been using the OX work boots for a while now. It's great to know these boots are built for the toughest of worksite conditions and will provide all-day comfort!”

Matt Miles | EST Building



SAFETY GLASSES – CLEAR

FEATURES

- Stylish design with adjustable nose bridge for comfort
- Medium impact anti-scratch, anti-fog lens
- 99.9% UV protection for outdoor wear
- Complies with AS/NZS1337

Product code	Barcode	Colour	Inner Qty	Outer Qty
OX-S240210	9341231011320	Clear	12	144



Clear

SAFETY GLASSES – SMOKE

FEATURES

- Stylish design with adjustable nose bridge for comfort
- Medium impact anti-scratch, anti-fog lens
- 99.9% UV protection for outdoor wear
- Complies with AS/NZS1337

Product code	Barcode	Colour	Inner Qty	Outer Qty
OX-S240220	9341231011337	Smoke	12	144



Smoked

SAFETY GLASSES – BLUE MIRRORED

FEATURES

- Stylish design with adjustable nose bridge for comfort
- Medium impact anti-scratch, anti-fog lens
- 99.9% UV protection for outdoor wear
- Complies with AS/NZS1337

Product code	Barcode	Colour	Inner Qty	Outer Qty
OX-S240230	9341231011344	Blue mirrored	12	144



Blue Mirror



Safety Equipment

SAFETY SPECS - CLEAR LENS



FEATURES

- Super lightweight comfort fit design
- Max flex arms
- Impact resistant polycarbonate clear lens
- Anti-scratch
- Anti-fog



Clear

Product code	Barcode	Colour	Inner Qty	Outer Qty
OX-S581401	5060530356249	Clear Lens	12	300

SAFETY SPECS - SMOKED LENS



FEATURES

- Super lightweight comfort fit design
- Max flex arms
- Impact resistant polycarbonate clear lens
- Anti-scratch
- Anti-fog



Smoked

Product code	Barcode	Colour	Inner Qty	Outer Qty
OX-S581402	5060530356256	Smoked Lens	12	300

SAFETY PROTECTIVE SPECTACLE VISITOR'S GLASSES



FEATURES

- Lightweight and comfortable
- Tough polycarbonate lens with wide vision & impact protection
- Fits over spectacles
- Uncoated clear lens with UV protection
- Visitors glasses



Clear

Product code	Barcode	Colour	Inner Qty	Outer Qty
OX-S581201	5060530356232	Clear	12	300



SAFETY WIDE VISION GOOGLES

FEATURES

- Tough polycarbonate lens for chemical splash and impact resistance
- Comfortable soft vinyl frame for comfort
- Fits over personal spectacles
- Ideal for protection against dust and impact
- Indirect vents for optimum ventilation

Product code	Barcode	Colour	Inner Qty	Outer Qty
OX-S581501	5060530356263	Clear	12	108



Clear

New

SAFETY GOOGLES – DIRECT VENTILATION

FEATURES

- Lightweight, tough polycarbonate lens
- Soft, flexible vinyl frame
- Fits over personal spectacles
- Ideal protection against dust and impact
- Direct ventilation

Product code	Barcode	Colour	Inner Qty	Outer Qty
OX-S581601	5060530356270	Clear	20	120



Clear

New

SAFETY GOOGLES – INDIRECT VENTILATION

FEATURES

- Ideal protection against dust and impact
- Soft, flexible vinyl frame
- Tough polycarbonate lens
- Fits over personal spectacles
- Indirect ventilation

Product code	Barcode	Colour	Inner Qty	Outer Qty
OX-S581701	5060530356287	Clear	20	120



Clear

New



Safety Equipment

SAFETY FACE SHIELD



New

FEATURES

- Trade face shield/head gear eliminates forehead injury
- Comfortable & adjustable head strap
- Chin guard and brow guard
- Clear polycarbonate visor

Product code	Barcode	Size	Inner Qty	Outer Qty
OX-S580901	5060530356225	7" x 15 1/2"	24	24

SAFETY PREMIUM VENTED SAFETY HELMET



New

FEATURES

- Impact resistant ABS shell
- 6 Point ratchet type nylon suspension
- Pin lock/ self adjust
- Vented for air flow
- Easy fit/adjustment to fit all sizes
- Approved for AS/NZS 1801: 1997 Occupational Protective Helmets

Product code	Barcode	AS/NZS	Inner Qty	Outer Qty
OX-S580101	5060530356126	Approved for AS/NZS 1801: 1997 Occupational Protective Helmets	0	20

SAFETY VENTED HARD HAT - WHITE



New

FEATURES

- Vented design for maximum breathability
- Attachment slot ensures the hard hat is compatible with 25mm and 30mm attachments
- Made from ABS polymer material
- Adjustable 6 point harness (50cm - 66cm)
- Rain guard and reinforced peak will help to prevent the weather from affecting view
- Approved for AS/NZS 1801: 1997 Occupational Protective Helmets

Product code	Barcode	AS/NZS	Inner Qty	Outer Qty
OX-S489511	9341231055966	Approved for AS/NZS 1801: 1997 Occupational Protective Helmets	0	20

SAFETY PROTECTED NECK BRIM



New

FEATURES

- Protects the neck from sun exposure & rain
- 100% Polyester tricot – lightweight & durable
- No chin strap
- Foldable
- Easy to attach / detach from hard hats
- Full brim for maximum coverage
- Available in various colours

Product code	Barcode	Colour	Inner Qty	Outer Qty
OX-S580401	5060530356188	Cyan	50	100
OX-S580404	5060530356218	Yellow	50	100



SAFETY DISPOSABLE EAR PLUGS

FEATURES

- PU foam bullet earplug
- Cordless
- AS/NZS: Class 5 (200 pairs)
- Colour box/display dispenser

Product code	Barcode	Size	Inner Qty	Outer Qty
OX-S582401	5060530356324	-	0	20



New



SAFETY PREMIUM HEARING BAND

FEATURES

- Flexible and durable band fits comfortably over the ear canal
- Streamline & Lightweight Flex Band design
- Replaceable Ear Buds
- Spare Buds Available Separately

Product code	Barcode	Size	Inner Qty	Outer Qty
OX-S582603	5060530356362	-	15	300

- OX Replacement Earbuds for OX-S582603

Product code	Barcode	Size	Inner Qty	Outer Qty
OX-S582701	5060530356379	-	50	1000



New



SAFETY FOLDING EARMUFFS

FEATURES

- Collapsable folding design
- Material: ABS & stainless steel
- Comfort padding/headband
- AS/NZS: Class 5 / 29.5dB

Product code	Barcode	AS/NZS:	Inner Qty	Outer Qty
OX-S582801	5060530356386	Class 5/29.5dB	0	20



New



Safety Equipment

SAFETY PREMIUM EARMUFFS



New

FEATURES

- Premium style headband earmuff
- Padded comfort headband
- Material: ABS & stainless steel
- AS/NZS: Class 5 / 32.2dB

Product code	Barcode	AS/NZS:	Inner Qty	Outer Qty
OX-S582901	5060530356393	Class 5/32.2dB	0	20

SAFETY P2V DISPOSABLE DUST MASK-W/VALVED, 12PK



New



FEATURES

- Particulate filtration (dust, particles, fumes etc)
- Comfortable elastic straps
- PV2 valved face mask
- Lightweight & breathable construction
- Pinch nose protection

Product code	Barcode	Size	Inner Qty	Outer Qty
OX-S240910	9341231000164	12pk	0	12

SAFETY P2 DISPOSABLE DUST MASK-NON VALVED, 20PK



New



FEATURES

- Particulate filtration (dust, particles, fumes etc)
- Comfortable elastic straps
- Lightweight & breathable construction
- One size fits all

Product code	Barcode	Size	Inner Qty	Outer Qty
OX-S240810	9341231000157	20pk	0	12



SAFETY HIGH VISIBILITY RAIN SUIT - FLURO GREEN

FEATURES

- Polyester/PVC rainsuit
- Thickness: 0.18mm
- 170t polyester/PVC
- High visibility fluro green

Product code	Barcode	Size	Inner Qty	Outer Qty
OX-S585404	9341231050756	L	0	10
OX-S585405	9341231050763	XL	0	10
OX-S585406	9341231050770	XXL	0	10



New



SAFETY HIGH VISIBILITY VEST

FEATURES

- Lightweight & breathable
- Reflective tape for added safety at night
- Heavy duty velcro closer
- High visibility - fluro orange & yellow

Product code	Barcode	Colour	Inner Qty	Outer Qty
OX-S585501	5060530356539	Fluro Yellow	0	50
OX-S585502	5060530356546	Fluro Orange	0	50



New





Safety Equipment

SAFETY LATEX GLOVES - POLYESTER LINED



FEATURES

- Gauge polyester, knit wrist, latex crinkle coated palm
- Made of a high-performance latex, providing outstanding combination of strength and chemical resistance
- Offers protection against snags, punctures, abrasions, and cuts
- Minimum perspiration
- Comply with CE standard regulations, meet with EN420 and EN388

Product code	Barcode	Size	Inner Qty	Outer Qty
OX-S481310	9341231037610	10	12	144

SAFETY NITRILE GLOVES - NYLON LINED



FEATURES

- 15 Gauge nylon, knit wrist, nitrile foam coated palm
- Made of a high-performance nitrile, providing outstanding combination of strength and chemical resistance
- Offers excellent dry grip by moving oils and liquids away from the glove surface
- Excellent breathability
- Comply with CE standard regulations, meet with EN420 and EN388

Product code	Barcode	Size	Inner Qty	Outer Qty
OX-S481410	9341231037627	10	12	144

SAFETY POLYESTER LINED NITRILE GLOVE - 5 PACK



SIZE 9



FEATURES

- Durable rubber face with foam 'liner'
- 13 Gauge polyester knit wrist with a smooth nitrile coated palm
- Made of high-performance nitrile, provides outstanding combination of strength and grip
- Offers excellent dry grip by moving oils and liquids away from the glove surface. Prevents grease oil and water penetration
- Complies with CE standard regulations, meet with EN420 and EN388

Product code	Barcode	Size	Inner Qty	Outer Qty
OX-S484609	9341231018732	9	1	25
OX-S484610	9341231017513	10	1	25



SAFETY DELUXE KNEE PAD

FEATURES

- Durable rubber face with foam 'liner'
- Quick release 'hook and loop' fastening
- One size fits all
- Ideal for professional trade, D.I.Y or gardening



Product code	Barcode	Size	Inner Qty	Outer Qty
OX-S240102	9341231011740	One Size Fits All	4	24

SAFETY GEL FILLED KNEE PAD - HEAVY DUTY

FEATURES

- Ergonomic shape for stability and comfort for use over long periods
- Anti compression air injected gel and foam EVA core for maximum cushioning
- Perforated neoprene lining to keep away moisture
- One size fits all
- Easy positioning of knee pad



Product code	Barcode	Size	Inner Qty	Outer Qty
OX-S585702	5060530356553	One size fits all	0	12

SAFETY RED/WHITE DOUBLE SIDED BARRIER TAPE - BOX OF 20

FEATURES

- Heavy duty plastic
- Red and white striped
- Double sided print



Product code	Barcode	Size	Inner Qty	Outer Qty
OX-S243210	9341231011979	75mm x 100m	1	10



Safety Equipment

BLACK ELASTIC SIDED PULL ON WORKBOOTS



New

FEATURES

- Black Crazyhorse Full Grain leather 1.6mm
- Steel toe and stainless steel midsole with added heel support
- Nylon mesh lining for breathability
- Anti-slip PU outsole with oil, heat and chemical resistance



BONUS
PAIR OF
SOCKS

Product code	Barcode	Size	Inner Qty	Outer Qty
OX-S487606	9341231043222	6	1	5
OX-S487607	9341231043239	7	1	5
OX-S487608	9341231043246	8	1	5
OX-S487609	9341231043253	9	1	5
OX-S487610	9341231043260	10	1	5
OX-S487611	9341231043277	11	1	5
OX-S487612	9341231043284	12	1	5
OX-S487613	9341231043291	13	1	5

SAFETY WELLINGTON BOOT

FEATURES

- Oil, acid and abrasion resistant
- Tradesman quality with steel safety toe
- Reinforced ankle and shin for greater protection
- Sole channelling for improved liquid disposal and slip resistance



MADE IN PORTUGAL

Product code	Barcode	Size	Inner Qty	Outer Qty
OX-S242406	5060242331541	6	1	5
OX-S242407	5060242331558	7	1	5
OX-S242408	5060242331565	8	1	5
OX-S242409	5060242331572	9	1	5
OX-S242410	5060242331589	10	1	5
OX-S242411	5060242331596	11	1	5
OX-S242412	5060242331602	12	1	5
OX-S242413	5060242331619	13	1	5



SAFETY NUBUCK ZIPPER BOOT

FEATURES

- Heavy duty hexagonal metal eyelets
- Steel toe cap & mid-sole
- 8 gauge YKK straight zip
- Water resistant oxford nylon mesh panel for comfort, breathability & wicking
- SRC outsole for slip resistance.
- Anti-static & fuel resistant.
- Removeable PU moulded gel Insole for extra comfort and cushioning
- PU/rubber density outsole – heat resistant to 300 °C
- TPU anti-scuff protection
- Full grain cow leather (1.6 – 1.8mm)
- Available in sizes: 6–13



Product code	Barcode	Size	Inner Qty	Outer Qty
OX-P483306	9341231017933	6	1	5
OX-P483307	9341231017940	7	1	5
OX-P483308	9341231017957	8	1	5
OX-P483309	9341231017964	9	1	5
OX-P483310	9341231017971	10	1	5
OX-P483311	9341231017988	11	1	5
OX-P483312	9341231017995	12	1	5
OX-P483313	9341231018008	13	1	5



Merchandising





Also for storing products
inside the stand



ME-DSMS04

Versatile display option for stocking a wide range of OX products with 4 sides and the ability to move easily.
Dimensions: W: 66CM x H: 178CM x D: 66CM

Compact low gondola stand with double sided kit available for extra flexibility.
Dimensions: 103CM x 151CM x 52/98.5CM



Merchandising



OX Stackable Box Display - 34cm Wide
OXPOS-STACKBOX

Dimensions:
W: 34CM x H: 41CM x D: 46CM



OX Level Display Stand
OXPOS-LEVEL1

Dimensions:
W: 36.5CM x H: 46CM x D: 26CM

(measurements do not include any levels)



OX Hammer Rack - Suits 3 Hammers

ME-DSHR03
Dimensions:
W: 25CM x H: 53CM x D: 16CM



OX 1/4 Pallet Dump Bin with 5 Insert Trays

OX-DS450205
Dimensions:
W: 58.5CM x H: 100CM x D: 58.5CM



OX Diamond Counter Display - 4", 5" and 9"

OX-DS451703
Dimensions:
W: 50CM x H: 32CM x D: 14CM



OX Universal Counter Display - 2 Hook

OX-D452402
Dimensions:
W: 30CM x H: 40CM x D: 15CM



Diamond Blade Troubleshooting Guide

LOSS OF TENSION



CAUSES

Using the wrong blade on a specific material. A blade specifically designed and manufactured for cutting tiles will wear out extremely fast if used on highly-abrasive material such as block.

Inadequate water is supplied to the blade.

Bad spindle bearings, worm mounting arbor, or misaligned shaft.

Loss of power, resulting from loose drive belts or improper voltage.

REMEDIES

Avoid using general purpose specifications for cutting a single specific material. General purpose diamond blades are designed to cut a wide range of materials. Since it is unlikely an operator will be cutting an equal amount of both hard and soft materials at all times, this is not the most economical method of cutting.

Make sure water hoses are clean and free from any blockages. Approximately nine litres of water per minute are required to properly cool a masonry saw blade. On concrete saws, 9-22 litres per minute are required.

Replace defective parts.

See machine manual for proper belt tightening, replace worn belts, make sure proper line voltage is being supplied to the motor.

BLADE WOBBLES

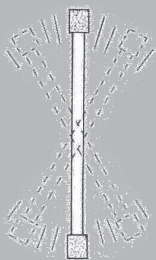

Blade is too hard for material being cut.

Blade has become dull as a result of being used on too hard a material.

Blade does not cut material it was specified for.

Insufficient power, not allowing blade to cut properly. Often, the blade will stall in the cut.

Select the proper blade specification for the material being cut. Consult blade recommendation chart.

Dress or sharpen with mortar droppings or by cutting a lightweight abrasive building block to expose diamonds. If continual dressing is required, the blade specification is too hard for the material being cut.

First, make sure the blade is correct according to the blade recommendation chart. If the blade is correct, allow it to dress itself on the material to be cut. If it does not dress itself, sharpen it as you would a dull blade, according to the procedure described above.

Tighten belts in accordance with machine maintenance instructions. Use correct voltage at motor and adequate horsepower for cutting application.



Diamond Blade Troubleshooting Guide

SEGMENT LOSS

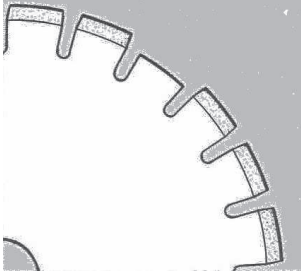

CAUSES

On masonry saws, the material is not held firmly, which causes the blade to twist or jam in the cut and loosen the segment.

Overheating is due to inadequate supply of water or complete loss of water. This is usually accompanied by discolourations which appear on the steel centre near the area of segment loss.

Steel centre is worn thin as a result of undercutting by abrasive fines generated during cutting. The steel centre (blank) wears to a knife edge, weakens and causes a segment to be separated.

Defective blade collars cause the blade to flutter in the cut or fail to adequately support the blade in perfect alignment.

Blade is too hard for material being cut, causing excessive dullness and segment separation due to impact or fatigue. This can also cause frictional heat that can melt the braze when insufficient water is supplied to the blade.

Blade is cutting out of round resulting in a pounding impact.

Improper blade tension causes high pressure on the segments and subsequent failure of the brazed joint.

REMEDIES

Hold the material firmly against the backstop.

Provide adequate water flow to both sides of the blade. Look for line blockages. On concrete saws, temporary complete loss of water can result from equipment running over the water feed hoses.

Use sufficient water to flush fines out of the cut. If generated fine s are highly abrasive, blades with undercut protection.

Clean foreign material from the blade clamping disc surfaces, ore replace clamping discs if they are under manufacturer's recommended diameter.

Use the proper blade specifications for the material being cut.

Replace worn bearing, realign blade shaft, or replace worn spindle.

Make sure the running speed of equipment is specified when ordering blades. On concrete saws, the spindle speed should be checked with a tachometer to ensure that each diameter blade is running at the recommended cutting speed and blade-tensioned speed.

DISTORTED CENTRE STEEL



Inadequate tightening of the blade on concrete saw mounting shaft. This causes drive pin to force its way through blade blank.

Dropping saw head with mounted blade particularly on concrete saws. Also dropping objects on unmounted blade distorts blade blanks.

Tighten clamping nut securely.

Avoid dropping the blade. Protect blade from abuse and handle with care.



Diamond Blade Troubleshooting Guide

UNEVEN SEGMENT



CAUSES

Insufficient water, generally to one side of the blade, reduces side clearance and does not flush out fines.

Equipment defects cause the segment to wear unevenly.

Saw head is misaligned.

REMEDIES

Flush out the water system. Make certain that water is adequately and evenly distributed to both side of the blade.

Replace bad bearings, worn or misaligned spindle. On concrete saws, the engine must run smoothly to prevent harmonic vibrations which cause the blade to pound on a regular cycle basis.

Check saw head alignment for squareness both vertically and horizontally.

CRACKS IN SEGMENTS

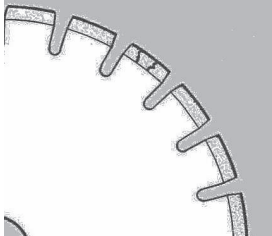

The blade is too hard for the material being cut.

Use blade with a softer bond.

CRACKS IN STEEL CENTER

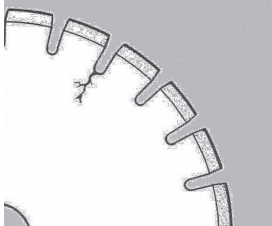

Blade flutters in a cut as a result

Blade specification is too hard for material being cut.

Forcing blade in operation.

Twisting blade in cut.

Tighten the blade clamping disc nut. Be sure that the blade is running at the properly tensioned speed and that the drive pin is functioning properly.

Use softer blade bond to eliminate stresses which create cracks.

Allow blade to cut freely without bouncing.

Ensure blade is kept in straight line do not force around corners.



Diamond Blade Troubleshooting Guide

SHORT LIFE

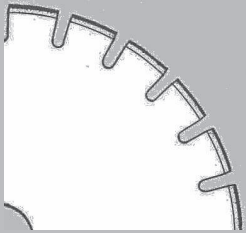

CAUSES

Using the wrong blade on a specific material. A blade specifically designed and manufactured for cutting tiles will wear out extremely fast if used on highly-abrasive material such as block.

Inadequate water is supplied to the blade.

Bad spindle bearings, worm mounting arbor, or misaligned shaft.

Loss of power, resulting from loose drive belts or improper voltage.

REMEDIES

Avoid using general purpose specifications for cutting a single specific material. General purpose diamond blades are designed to cut a wide range of materials. Since it is unlikely an operator will be cutting an equal amount of both hard and soft materials at all times, this is not the most economical method of cutting.

Make sure water hoses are clean and free from any blockages. Approximately nine litres of water per minute are required to properly cool a masonry saw blade. On concrete saws, 9-22 litres per minute are required.

Replace defective parts.

See machine manual for proper belt tightening, replace worn belts, make sure proper line voltage is being supplied to the motor.

BLADE WILL NOT CUT

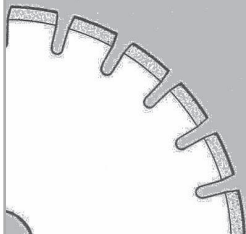

Blade is too hard for material being cut.

Blade has become dull as a result of being used on too hard a material.

Blade does not cut material it was specified for.

Insufficient power, not allowing blade to cut properly. Often, the blade will stall in the cut.

Select the proper blade specification for the material being cut. Consult blade recommendation chart.

Dress or sharpen with mortar droppings or by cutting a lightweight abrasive building block to expose diamonds. If continual dressing is required, the blade specification is too hard for the material being cut.

First, make sure the blade is correct according to the blade recommendation chart. If the blade is correct, allow it to dress itself on the material to be cut. If it does not dress itself, sharpen it as you would a dull blade, according to the procedure described above.

Tighten belts in accordance with machine maintenance instructions. Use correct voltage at motor and adequate horsepower for cutting application.



Diamond Blade Troubleshooting Guide

BLADE BORE OUT-OF-ROUND

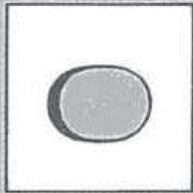

CAUSES

Blade collar is not properly tightened, permitting blade to either rotate or vibrate on shaft.

Blade collars are worn or dirty not allowing proper blade clamping.

Blade is not properly mounted.

REMEDIES

Tighten the spindle nut with a spanner to make certain that the blade is adequately secured to prevent rotation on shaft.

Clean blade collars, making sure they are not worn. Tighten arbor nut properly.

Make certain the blade is mounted on the proper shaft diameter before tightening arbour nut. On concrete saws, make certain the pin hole slides over arbour drive pin. Never depend on the drive pin to actually drive the blade. A drive pin is simply a safety measure to prevent the blade from spinning on its spindle should the nut become loose.

UNDERCUTTING STEEL CENTRE



Abrading or wearing away of the steel centre faster than the diamond segment is due to highly abrasive fines generated during cutting.

Use as much water as possible to flush out fines generated during cutting or use blades with undercut protection. NOTE: Blades with undercut protection are not always the final answer to eliminating undercutting. Care must still be taken to provide sufficient water to the steel centre are immediately adjacent to the segment. This is especially important when making deep cuts.

BLADE WORN OUT-OF-ROUND

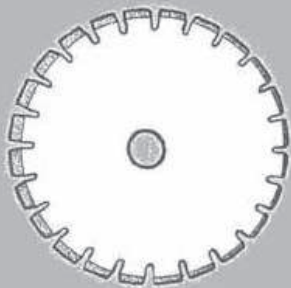

Shaft bearings on masonry or concrete saws are worn, causing the blade to run eccentrically and wear out-of-round.

Engine is not properly tuned on concrete saws, causing surges in blade rotation.

Blade spindle hole is damaged from previous mismounting.

Blade mounting spindle is worn. A groove may have been scoured on the mounting spindle as a result of previous blades spinning on the arbor. When a new blade is placed on such a worn spindle, it seats improperly and runs eccentrically.

Blade slips on arbor shaft.

Bond is too hard for material causing machine to 'pound' at regular intervals, wearing one half of the blade more than the other half.

Install new blade shaft bearings or blade shaft, as required.

Tune engine according to saw manufacturer's manual.

For large diameter blades it may be possible to rebraze segments to a new centre.

Replace worn shaft or spindle bushing.

On a masonry saw, tighten the blade collar. On a concrete saw, make certain that the drive pin is functioning.

Use proper blade specification.



FAQ's

Can I place an order without an account?

How do I apply for an account?

How long will it take for my account to be opened? .

Do you provide your pricelist in an excel version?

Do you accept credit cards?

Do you have a minimum order value?

Do you offer same day dispatch?

Does OX sell to the public?

How long has the OX brand been around?

What are the pack quantities?

What category do you specialise in?

What is my sales representative's mobile number? ..

What is our minimum order value for FIS?

What is the freight charge under FIS?

What is your returns policy?

Answers

An account application must be completed and approved as an eligible distributor before placing orders.

Email the Customer Service Team at sales.au@oxtools.com for an account application form.

Once the application has been submitted, it will be reviewed within 5 business days.

Contact the Customer Service Team at sales.au@oxtools.com to receive a copy.

Mastercard, VISA and Amex are accepted.

\$50 is the minimum order value.

All orders placed by 12:00pm AEST will be dispatched the same day

OX only sells to authorised resellers, these distributors can be located on our website.

Our tool range was born in 1974 in Perth, Australia and was launched under the OX brand at the beginning of 2010.

All pack quantities are listed in this catalogue.

OX Tools has 46 years of experience in the wet trade tool market, diamond tool market and offers a range in multiple categories in the construction industry.

Call the Customer Service Team on 02 8845 6600 and they can provide your sales representative's mobile number.

\$350 Net

\$30.00 excluding access products. Contact our Customer Service Team for a price for freight costs on our access product range.

At OX, we have a sale or return policy. If you cannot sell an OX brand product within 3 months of purchase, simply return it in a suitable/saleable condition for a full refund.



Terms and Conditions

1. INTERPRETATION

- (a) 'Contract' means the standard trading terms and conditions of sale (which applies to each and every Quotation and/or Order) and includes any Quotation and Order.
- (b) 'OX Tools' means OX Tools AU Pty Ltd (ABN 41151919569).
- (c) 'Customer' means the entity to which 'OX Tools' enters into a Contract for the sale of Goods.
- (d) 'Goods' means the products described in the Quotation or Order and includes replacement products.
- (e) 'Order' means a written or verbal order from the Customer to OX Tools.
- (f) 'Quotation' means a written or verbal quotation provided by OX Tools to the Customer.

2. ORDERS

- (a) Orders for Goods will be binding upon OX Tools and the Customer. However, OX Tools reserves the right to accept orders in whole or in part.
- (b) Once OX Tools has accepted an Order, the customer may not alter or modify the Order without the prior written consent of OX Tools.
- (c) A 30% restocking fee applies to all returned goods providing they are in re-saleable condition.

3. PRICES

- (a) All prices contained in the Quotation and/or Order will be exclusive of GST. All prices are in Australian dollars and subject to alteration without notice. All invoices are in Australian dollars and must be settled in Australian dollars.
- (b) Any order placed with a value of under \$50.00 excluding GST will not be processed. This minimum invoice value does not apply to back-orders.
- (c) Orders with an invoice value of over \$350.00 excluding GST will be shipped free in-store.
- (d) Orders with an invoice value of under \$350.00 excluding GST will incur a freight charge of \$30.00 + GST (freight charges subject to change).

4. PAYMENT AND CREDIT TERMS

- (a) Unless otherwise agreed in writing, the payment due date is strictly thirty (30) days from the end of the month in which the Goods are sold to the Customer.
- (b) Accounts with overdue balances will automatically have credit withdrawn until all outstanding balances are cleared. OX Tools reserves the right to charge interest at the rate of 2% on all overdue balances calculated on a daily basis from the due date until such amount is paid.
- (c) If the Customer defaults in payment of any invoice when due, the Customer will indemnify OX Tools from and against all OX Tools' costs and disbursements including a solicitor and own client basis and in addition to OX Tools' nominee's costs of collection.

5. DELIVERY OF GOODS AND RISK

- (a) Delivery of the Goods shall be made to the Customer's address. The Customer shall make all arrangements necessary to take delivery of the Goods whenever they are tendered for delivery.
- (b) The failure of OX Tools to deliver will not entitle the Customer to treat this Contract as cancelled.
- (c) OX Tools will not be liable for any loss or damage whatever due to failure by OX Tools to deliver the Goods (or any part of them) promptly or at all.
- (d) All risk for the Goods passes to the Customer on delivery even if OX Tools retains ownership.
- (e) Delivery will be free in store (FIS) Australia wide for Orders in excess of \$350.00 excluding GST. However, the Customer will be liable delivery charges if a delivery date is required outside of usual delivery times. Orders less than \$350.00 excluding GST will be subject to the current freight charge of \$30.00 + GST (freight charges subject to change)

6. RETENTION OF TITLE

- (a) All Goods remain the property of OX Tools until the Customer has paid for the Goods in full. If payment is made by cheque, payment will not be deemed to have been made until the cheque has been honoured.
- (b) If the Goods are on-sold by the Customer before payment to OX Tools, the proceeds of sale will become property of OX Tools.
- (c) If the Goods are not paid for pursuant to clause 4, OX Tools may give notice in writing to the Customer to return the Goods or any part of them to OX Tools.

- (d) OX Tools may enter the Customer's premises without notice at any time and take possession of the Goods and without being responsible for any damage thereby caused if:

- (i) The Customer does not pay for the Goods under clause 4;
- (ii) The Customer fails to return the Goods upon demand;
- (iii) A trustee in bankruptcy, administrator or receiver is appointed over the Customer;
- (iv) Winding-up proceedings in relation to the Customer are commencing; or
- (v) The Customer becomes bankrupt.

7. CLAIMS

- (a) The Customer will inspect the Goods on delivery and will within seven (7) days of delivery notify OX Tools in writing of any alleged defect, shortage in quantity, errors, omissions or failure to comply with the Order or Quotation.
- (b) The Customer will afford OX Tools the opportunity to inspect the Goods within a reasonable time of delivery if the Customer believed the Goods are defective in any way. If the Customer fails to comply with these provisions, the Goods will be deemed to be free from any defect or damage and payment will be owing under this Contract.
- (c) If OX Tools agrees in writing that the Customer is entitled to reject the Goods because they are defective:
 - (i) The Goods must have a corresponding invoice number quoted;
 - (ii) Freight charges incurred for the return of the Goods being returned is at the expense of the Customer, unless otherwise agreed; and
 - (iii) OX Tools' liability is limited to either replacing or repairing the Goods at its discretion.
- (d) OX Tools does not warrant that the Goods are fit for any particular purpose or an intended use by the Customer.

8. LIMITATION OF LIABILITY

- (a) Subject to clause 8(b), OX Tools will have no liability whatsoever for any direct or indirect losses, expenses, damages and costs incurred by the Customer caused by any breach by OX Tools of this Contract or any negligent act or omission.
- (b) The liability of OX Tools to the Customer in the event of any breach of this Contract or other cause of action will not exceed the prices of the Goods.

9. PRIVACY ACT 1998

- (a) The Customer agrees for OX Tools to obtain from a credit-reporting agency and the trade referees a credit report containing personal credit information about the Customer and any additional information required by OX Tools.
- (b) OX Tools may exchange information about the Customer with those trade referees name in the application form for a trading account or named in a consumer credit report issued by reporting agency to:
 - (i) Assess the Customer's application;
 - (ii) Notify other credit providers of a default by the Customer;
 - (iii) Exchange other information with other credit providers as to the status of the trading account, if the Customer is in default with other credit providers; and
 - (iv) Assess the credit worthiness of the Customer.

10. GENERAL

- (a) If any provision of these terms and conditions becomes void or unenforceable, it will be severed from this agreement without affecting the enforceability of the other provision, which will continue to have full force and effect.
- (b) These terms and conditions are governed by the laws of New South Wales and each party irrevocably and unconditionally submit to the nonexclusive jurisdiction of the courts of New South Wales.
- (c) OX Tools may terminate or vary this Contract or cancel delivery of Goods at any time before the Goods are delivered by giving written notice. OX Tools will not be liable for any loss or damage whatever arising from termination or cancellations.
- (d) The Customer acknowledges and agrees that the goods sold to the Customer by OX Tools cannot be offered for sale through third party shopping websites or platforms (including but not limited

to Amazon and Ebay) without the express written authorisation of OX Tools.

11. PERSONAL PROPERTY SECURITY ACT (PPSA)

11.1 The Customer agrees, at the request of OX Tools, to enter into a Security Agreement with OX Tools to grant in favour of OX Tools a Security Interest in all the Customer's present and after acquired property relating to the Goods.

11.2 The Customer acknowledges and agrees that it shall, within 14 days of request from OX Tools, do all things and sign all documents as required by OX Tools to register, confirm or validate the Security Interest created over the Customer's assets by any Security Agreement.

11.3 OX Tools may exercise its rights under the Security Agreement any time after the Customer fails to comply with this Agreement, without OX Tools first having to take any action or enforce any of its other rights against the Customer.

11.4 The Customer will be entitled to a release of the Security Agreement when all its obligations under this Agreement have been satisfied.

11.5 The Customer shall not without OX Tools' prior written consent, which will not be unreasonably withheld, do any of the following:

- (a) acquire any asset which is, or upon acquisition, will be subject to a Security Interest which is not a Permitted Security Interest; or
- (b) give any person other than OX Tools control or possession of the Goods (other than under a Permitted Security Interest).

11.6 The Customer agrees that it will promptly take such action as OX Tools may require (including providing information or signing documents) to ensure that any Security interest granted in favour of OX Tools attaches to the secured property and to enable OX Tools to perfect any such Security Interest or otherwise exercise any rights that it may have under the PPS Law in relation to the secured property.

11.7 The Customer acknowledges and agrees that, from the registration commencement time under the PPSA:

- (a) it shall not cause or permit any person to take a Security Interest over, or to register a financing statement in relation to, any secured property without the prior written consent of OX Tools and will immediately notify OX Tools if it becomes aware of any person taking steps to register a financing statement in relation to such secured property;
- (b) it has no rights under, or by reference to, sections 125, 142 and 143 of the PPSA if it defaults and OX Tools takes enforcement action under this Agreement in respect of the secured property;
- (c) it waives its rights to:
 - (i) receive any notice under sections 95, 130 and 135 of the PPSA in relation to the enforcement of any Security Interest over the secured property;
 - (ii) receive a statement of account under section 132(3)(d) and 132(4) of the PPSA if OX Tools disposes of any of the secured property following repossession of that secured property; and
 - (iii) receive a copy of, or notice of, any verification statement confirming registration of a financing statement or a financing change statement relating to any Security Interest under, or provided for by, this Agreement.

11.8 Except if section 275(7) of the PPSA applies, each party to this Agreement agrees not to disclose any information of the kind referred to in section 275(1) of the PPSA that is not publicly available.



Warranty

OX Tools AU Pty Ltd (OX Tools) warrants that all goods supplied by it and purchased by you from Authorised OX Tools Dealers throughout Australia are free of defects except for those goods listed under Warranty Exclusions.

Warranty Claims

If you consider that any goods supplied by OX Tools is defective, you can lodge a claim under this Warranty and any apparent fault will be rectified free of charge by OX Tools or an Authorised OX Tools Dealer within the Warranty Period, which is effective from the date of purchase provided that you meet the following conditions;

- You must produce the original invoice/receipt or other proof of purchase document disclosing the purchase date.
- All costs of installation, cartage, freight, travelling expenses, hiring tools and insurance are paid by the customer.
- The goods, being precision equipment, has not been misused, adjusted or serviced by any person other than an Authorised OX Tools Dealer.
- The equipment has been installed correctly and is used in accordance with the OX Tools instructions supplied with the goods.

OX Tools provides this warranty in addition to all other rights and remedies that you may have under law in relation to the goods to which this warranty relates.

Our goods come with guarantees that cannot be excluded under the Australian Consumer Law. You are entitled to a replacement or refund for a major failure and for compensation for any other reasonably foreseeable loss or damage.

You are also entitled to have the goods repaired or replaced if the goods fail to be of acceptable quality and the failure does not amount to a major failure.

Notwithstanding the preceding clause, OX Tools' liability in respect of a breach of a consumer guarantee or any warranty made under these Conditions of Warranty for any goods not of a kind ordinarily acquired for personal, domestic or household use is limited, to the extent permissible by law and at the option of OX Tools to:

1. Replacing the goods or the supply of equivalent goods;
2. The repair of the goods;
3. The payment of the cost of replacing the goods or of acquiring equivalent goods; or
4. The payment of the cost of having the products repaired.

To the extent permitted by law, all other warranties whether implied or otherwise, not set out in these Conditions of Warranty are excluded and OX Tools is not liable in contract, tort (including, without limitation, negligence or breach of statutory duty) or otherwise to compensate the customer for:

1. Any increased cost or expenses;
2. Any loss of profit, revenue, business, contracts or anticipated savings;
3. Any loss or expense resulting from a claim by a third party; or
4. Any special, indirect or consequential loss or damage of any nature whatsoever.

If you wish to make a claim under this Warranty, you should:

- Contact by Phone: +612 8845 6600;
- Visit your nearest Authorised OX Tools Dealer;
- Visit OX Tools website for details: www.oxtools.com

These conditions may only be varied with the written approval of the directors of OX Tools.

Warranty Period

Product Type	Warranty Period
Diamond Tools	12 Months
Hand Tools	12 Months
Access Equipment	12 Months
Safety Equipment	12 Months
Construction Machinery	12 Months

Warranty Exclusions

This section identifies what is excluded under this Warranty. This Warranty does not cover damage caused by:

- Misusing, overloading or abusing the OX goods,
- Operating the goods in a manner that is not in accordance with the OX Tools instructions supplied with the goods (the "Instruction Manual"),
- Failing to clean the goods in accordance with the instructions for correct and regular cleaning as set out in the Instruction Manual,
- Not carrying out periodic maintenance,
- Neglecting or otherwise failing to maintain the goods in accordance with the

instructions for maintenance of the goods including regular tune-ups, lubrication etc,

- Using incorrect voltage or non-authorized electrical connections with the goods,
- Installing the goods incorrectly,
- Using non authorised/non-standard parts, non-genuine OX Tools parts in connection with the goods,
- Repairing or carrying out any work on the goods by someone other than an Authorised OX Tools Dealer,
- Causing a double burnout - field and armature burnout,
- Operating the goods with any guard, shield or line cutting knife removed, repositioned, or that is incomplete or damaged,
- Using or operating the goods with any evidence of partial failure of goods or damage being present,
- Tampering with the goods in any way other than in accordance with the manual,
- Not having taken reasonable steps to prevent the damage or failure from occurring to the goods,
- Storing the goods inconsistently with manufacturer's recommendations or where the goods is exposed to corrosive substances such as fertilisers, grass and plant residue including palm tree sap, bore water and other detrimental environmental exposure,
- Making mechanical adjustments that are inconsistent with the Manual- including, chains, bars, engine tuning etc,
- Operating the goods with incorrect fuel to oil ratio,
- Having made improper adjustments of ignition timing or the carburettor,
- Using the goods with clogged or removed filters (i.e. fuel filter, oil filter, air filter),
- Using incorrect chain and bar oil/lubricant for the oil pump.

In addition to the above, this Warranty DOES NOT cover the following:

- Goods purchased:
 - Outside of Australia,
 - from a non-Authorised OX Tools Dealer (such as purchases from unauthorised retailers and purchases over the internet, from local/ international sellers or sites such as, but not limited to, Amazon and Ebay),
 - at an auction, or
 - from a private seller.
- Accidental damage or damage caused by an extra ordinary event or circumstance beyond your or anyone else's control including damage caused by:
 - environmental factors,
 - natural discolouration of material due to ultraviolet light,
 - crushing, impact with hard surface or damage caused in the transit of the goods, foreign material, or exposure of the goods to excessive heat or cold or to solvents, or water entry into the goods,
 - abnormal goods performance caused by any ancillary equipment interference or other external factors,
- Damage or failure that occurs for a reason or reasons that were already disclosed to you (in writing or otherwise), prior to your purchase of the goods,
- Damage or defects to the goods that ought reasonably to have been revealed to you by an examination of the goods, where you conducted such an examination before acquiring the goods,
- Normal wear and tear due to the course of normal use,
- Freight costs associated transporting the goods between you, the place of purchase, the Authorised OX Tools Dealer and OX Tools for the purposes of making a claim pursuant to this Warranty or otherwise,
- Repairs that are required by you to be made to the goods which are simply due to a clogged or restricted exhaust system, carbon deposits in exhaust ports, piston crown or combustion chamber or periodic decarbonising,
- Goods with serial number altered or removed,
- Refurbished, ex display or factory second goods,
- Consumable items supplied with the goods or that are a part of the goods,
- Service parts,
- Accessories, that for the avoidance of doubt include but are not limited to the following: those included with the goods at the time the goods was purchased by you including cases & site bags, brushes, chucks, cord sets, bulbs, LED's & lamps, driver & drill bits, blades, driver blades, o-rings, switches & triggers, power tool attachments, blades and cutters, spark plugs, carburettor kits, filters, bars & chains, cutting equipment, recoil springs, rope, belts, measuring devices, air (pneumatic) fittings, nose caps, gaskets, fuel hoses,
- The goods coming into contact with sand, water, rust, corrosion, fire, vermin and insect infestation, power outages or surges or inadequate voltage or current.

If the goods you are using has been rented or leased by you, and you consider a claim might be made under this Warranty, you should refer the matter to the rental or leasing company immediately and they will handle the matter.

This Warranty does not cover service costs in replacing and maintaining consumable parts and accessories that have ceased working through normal wear and tear such as, but not limited to: drill heads, blades, cutters and other parts classifiable as a consumable part or accessory.

OX Tools AU Pty Ltd
ABN 41 151 919 569
PO Box 498, Ermington, NSW, 1700, AUSTRALIA
(612) 8845 6600
www.oxtools.com.au





Notes

A series of horizontal dotted lines for writing notes, spanning the width of the page.



Notes

A series of horizontal dotted lines for taking notes, filling the majority of the page.



Safety

Safety is not something that is taken lightly at OX. When we design and build our tools the safety of the operator and safety of the tool is always the most important factor that is well thought-out during the whole process.

Safety when using OX tools is of paramount importance. Ultimately safety comes down to the operator which is why instructions need to be read and adhered to. It is also important to ensure the correct safety clothing is worn whilst working on a construction site.

Environmental

OX Tools is committed to managing environmental impact as an integral part of our operations. In particular, it is our policy to assure the environmental integrity of our processes and facilities at all times. We will do so by adhering to the following principles:

We employ management systems and procedures specifically designed to minimise the use of hazardous materials, energy and other natural resources, to minimise the generation of waste and to enable recycling and reuse of materials.

We continually seek opportunities to improve our environmental performance by establishing objectives and targets, measuring progress, and reporting our results; including but not limited to energy, water, paper and fuel consumption and vehicle miles travelled.

We promote participation and communicate our commitment to responsible environmental management by promoting environmental responsibility among our employees; by providing the necessary training and support to enable them to implement this policy; by informing suppliers of our environmental policy and encouraging them to adopt effective environmental management practices; and by soliciting input from our employees, suppliers, customers and board members in meeting our environmental goals.

OX[®]

UNLEASH THE POWER



OX Tools AU Pty Ltd
PO Box 498, Ermington
NSW 2115 AUSTRALIA

T: 02 8845 6600
E: sales.au@oxtools.com

For more information visit: oxtools.com

Subject to availability and OX Tools AU terms and conditions of sale. E & OE. © OX Tools AU

