

MEASUREMENTS

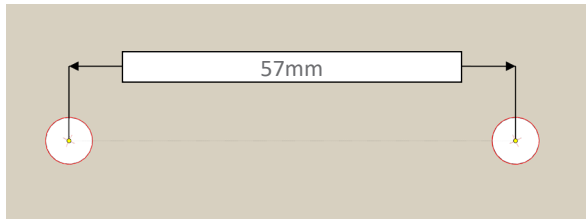

Brick

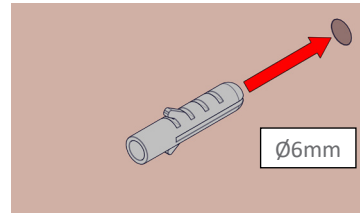

Plaster

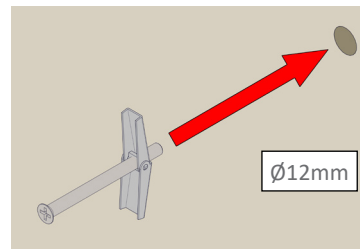

1

Make sure Soap Dish is level.
 Fasten Soap Dish to wall with screws.

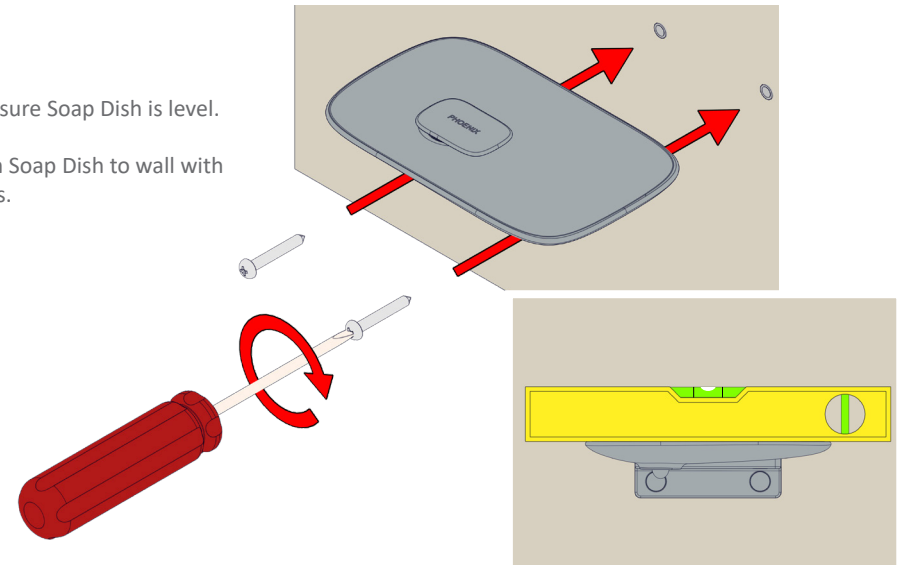

2

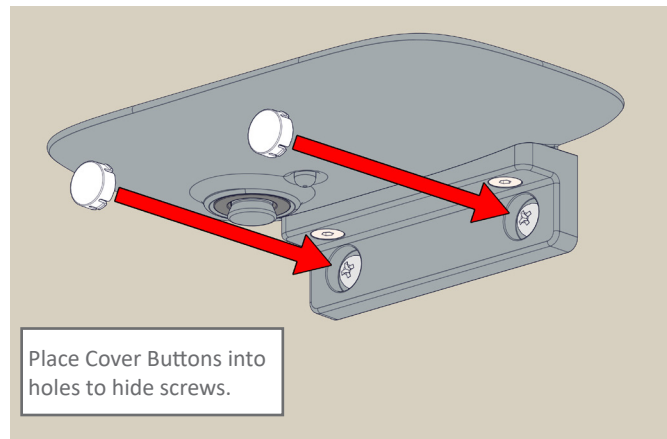

3

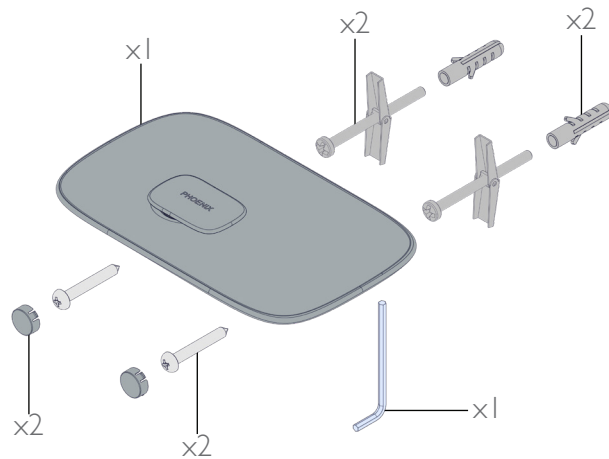
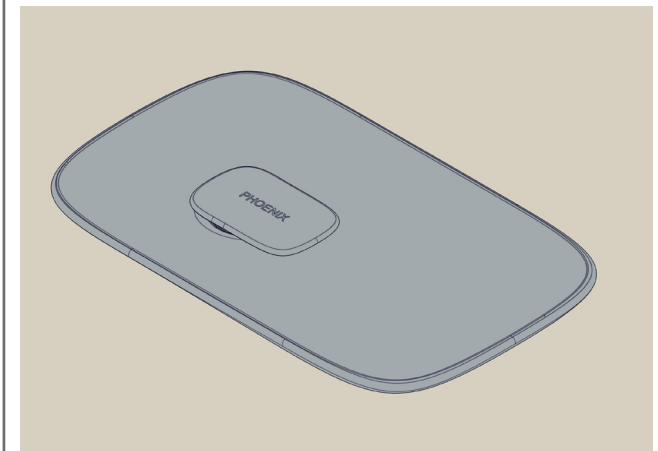

WARRANTY:
 Please refer to the full warranty statement enclosed with the product before installing.

MAINTENANCE AND CARE:

- Chrome plated surfaces should be cleaned with mild liquid detergent or soap and water.
- Do not use cream cleaners or citrus based cleaning products, as they are abrasive.
- Use of unsuitable cleaning agents may damage the surface. Any damage caused in this way will not be covered by warranty.

DISCLAIMER:
 While we aim to ensure the specifications shown are correct at the time of printing, we reserve the right to make modifications without prior notice. Always use the physical product measurements for mark-ups and roughing-in as the line drawing shown may differ from the actual product over time.

This product is suitable for all construction methods; Timber, brick, rammed earth etc -Provided it is installed to the guidelines specified in this instruction.

*All measurements are shown in millimeters.