

radiant
AUSTRALIA



Underfloor Heating Kits





INVISIBLE HEAT

A natural feeling of warmth with no fans or ducts



FULLY PROGRAMMABLE

Time AND temperature control in one touch screen unit



ON DEMAND

Fast to warm up (circa 30 minutes with insulation boards)



EASY INSTALLATION

Most versatile installation method available. You can DIY the heating element



WARM FLOOR

Warmth where you need it the most



SLEEK CONTROLLER

Highest quality touch-screen wall controller with backlight and 24/7 timer functionality



ASTHMA + ALLERGY FRIENDLY

No air or dust movement from ducted heating



TEMPERATURE CONTROL

Floor or room sensor to thermostatically control by temperature



BETTER BATHROOM DESIGN

As heat lamps are not required exhaust fans can be placed over showers



SAFE

IPX7 rated cable so can even be installed below the shower if required



DRY FLOOR

The heat dries floors and reduces chances of mould and cleaning requirements



MAINTENANCE FREE

Once installed it is maintenance free



ECONOMICAL TO RUN

About 4-5c / square metre per hour (at average household electricity prices and room size)

Overview



- Asthma + allergy friendly
- Economical to run
- No heat lamps means exhaust fans can be placed over showers
- Temperature control
- A dry floor means less mould
- On demand

Underfloor heating has proved extremely popular in Europe for many years and the number of installations in Australia is growing every year as people discover the many benefits of this type of heating, which in many cases can provide the primary heat source for the room. For commercial projects or larger homes, a hydronic (water based) system is often the more popular choice, however for bathrooms, living areas and smaller homes then the electric cable system can be a very good choice, especially when combined with good insulation and solar panels. With all underfloor heating systems, the floor is gently heated to a comfortable temperature (usually between 21 – 28 deg C depending on the room) and the heat generated slowly radiates into the room, in turn heating the air from the ground up. This gives a very even heat distribution throughout the room and offers a level of comfort which is far superior to other forms of heating.

UNDERFLOOR HEATING KITS



DANISH MANUFACTURED
CABLE MEANS
QUALITY AND RELIABILITY



CABLE GUARANTEED
FOR 10 YEARS

For bathrooms alone, electric is the stand out choice as it is quick and easy to install, easy to control, requires minimal, if any, changes to building process or its design.

For the rest of the home the popular choice is to heat the main living areas (family/dining/kitchen) and this can be installed in a concrete slab (fixed to the reinforcing steel), on top of a slab prior to screeding (In Screed), or directly below the tiles (under-Tile)

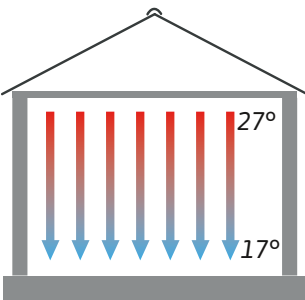
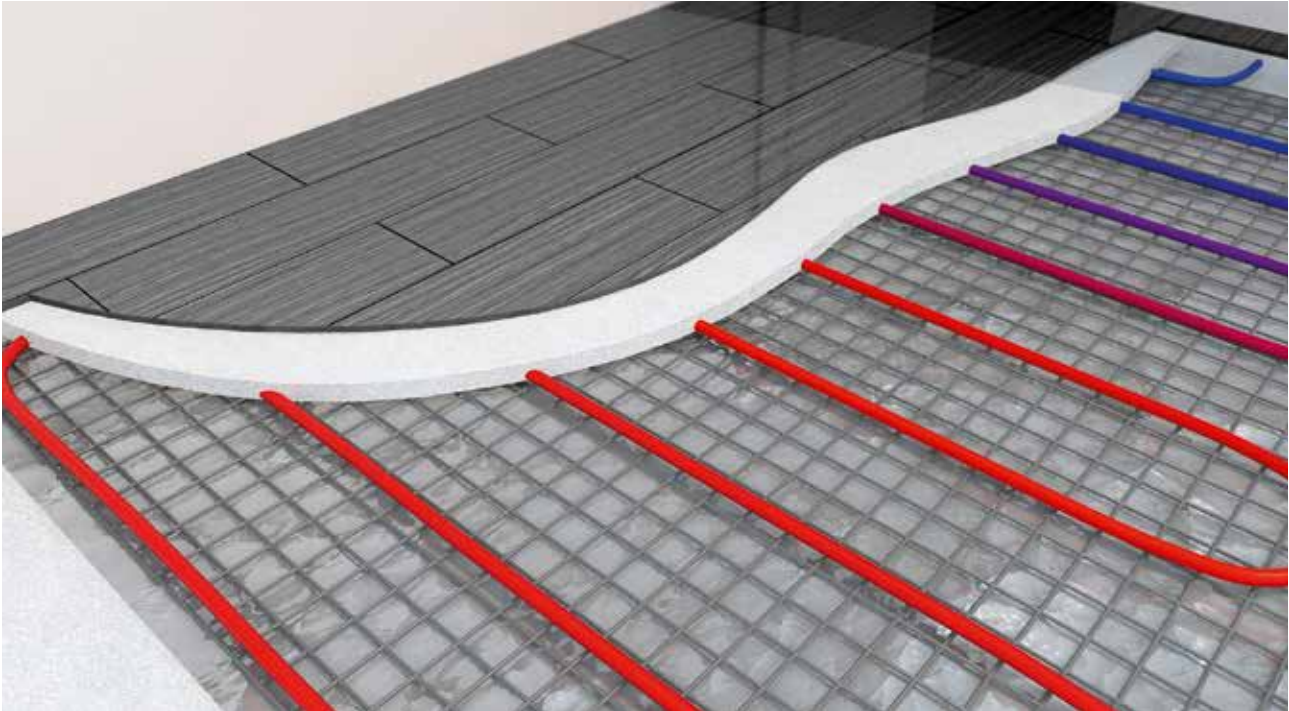

Reverse cycle heating generates warmth at the ceiling level, and as heat rises, struggles to adequately warm lower areas.

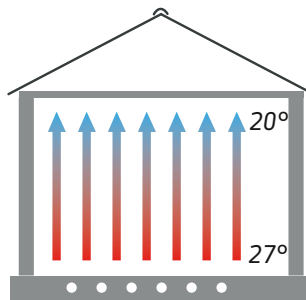

Underfloor heating gives you heating at the floor level, directly where you need it.

In-Screed

In-screed heating is the popular choice for living areas that are having a sand and cement screed to level up the floor, prior to laying large format, rectified or stone tiles. With this system the heating cables are fixed to the slab prior to screeding and then are fully protected during the tiling process. Because the cables are fixed to the concrete, with its thermal mass, this also acts in a similar way to in-slab heating, but with the cables slightly closer to the surface

In Screed heating is also the popular choice in bathrooms in states where the floors are screeded (WA, SA, NSW, QLD) in Victoria and Tasmania where bathrooms are generally not screeded, under-tile is the system of choice

For bathrooms the system can be supplied pre-spaced on mats, or as loose cable on a drum to suit the space and preferred installation method by the installer

Where possible installing a thin ThermaSheet insulating board below the screed will reduce the downward heat loss and improve warm-up times – this is ideal in a bathroom where the heating is generally only needed for shorter periods of time.

In-Screed systems are typically installed at between 100-150 watts per sqm in living areas and between 180-200 watts per sqm in bathrooms where there is usually limited free floor area a quicker warm-up is required.

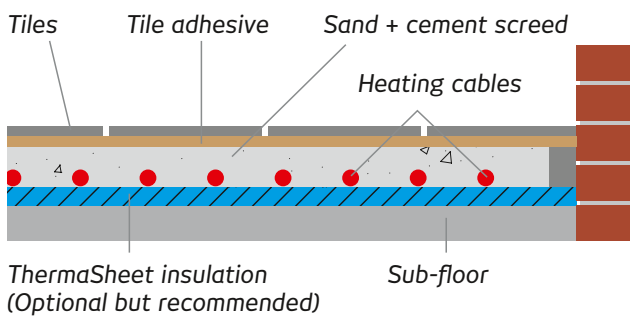



Under-Tile

Under-Tile systems, as with in-screed system in bathrooms, can be supplied as cable pre-spaced on a mat or loose on a drum. With the mat system the mesh is self-adhesive so will stick directly to a sealed or waterproofed floor while it is tiled over. Where large format, rectified or heavy stone tiles are being installed, we recommend first covering the cables or mats with a thin self-level to protect the heating cable during the tiling process. Again, Thermasheet insulation boards can be used to create a thermal break between the heating and sub-floor which will maximise efficiency. Under-tile system are typically installed at a similar output per sqm as in-screed as above.

Electrical Provisions

Electric Floor Heating is usually zoned on a room-by-room basis allowing you to heat different rooms at different times/temperatures. For example you may have an ensuite on at 6am heating to 28 deg floor temp, living room during the day at 24 deg and guest bathrooms only heated when occupied. Each zone would have its own 'set and forget' touch screen 7-day thermostat/timer, these can also be upgraded to WIFI versions controllable from an app on a phone or iPad.

For bathrooms/under-tile living areas

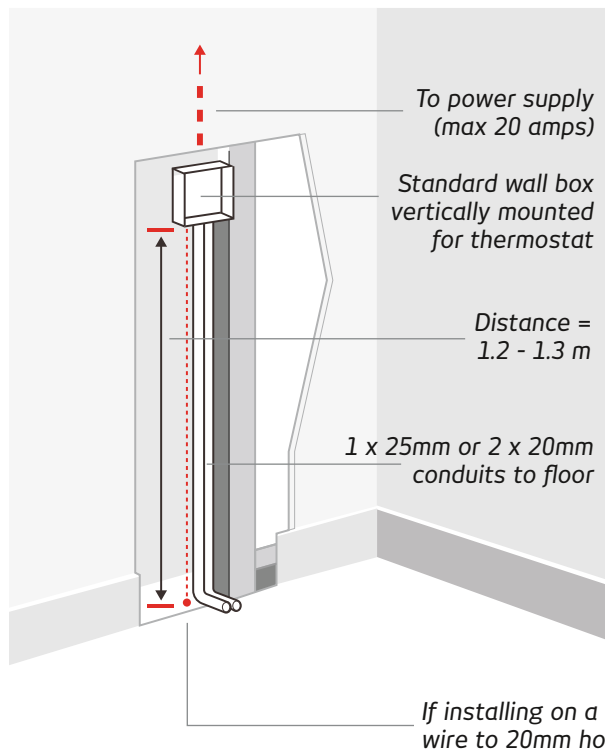

For bathrooms/under-tile living areas (brickwork)

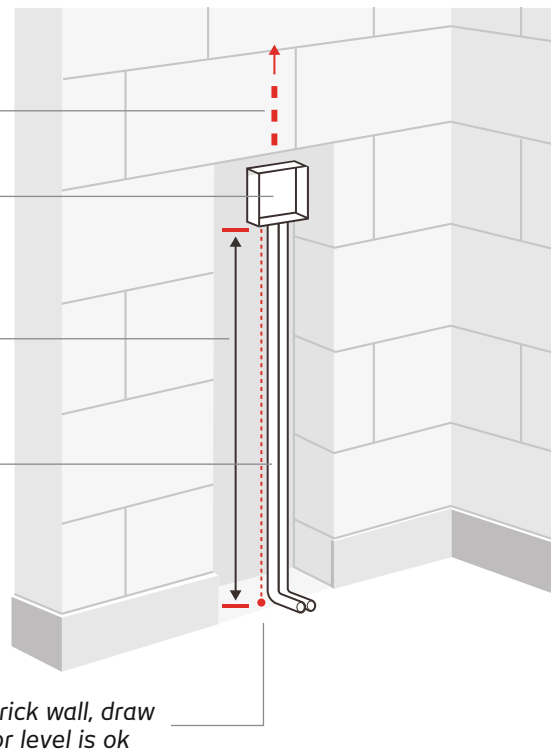

NOTE: Power must have RCD protection. For bathrooms the load will be no more than 0.8 amps per sqm 'free floor area'. For example: 9 sqm bathroom - bath, shower vanity = 5sqm x 0.8 = 4 amps. For larger areas the load will typically be 0.6 amps per sqm.

Combination floor heating thermostat and heated towel rail timer (dual)

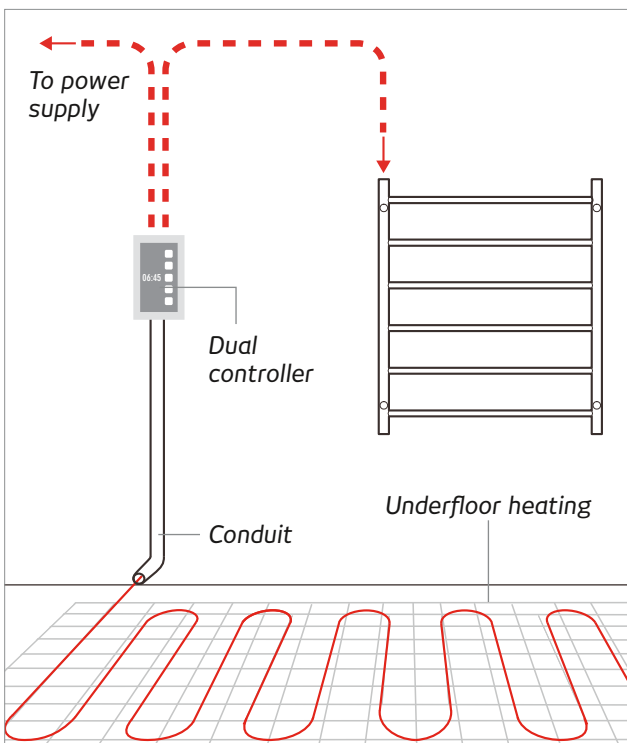

Heating cable and sensor installed and slab poured

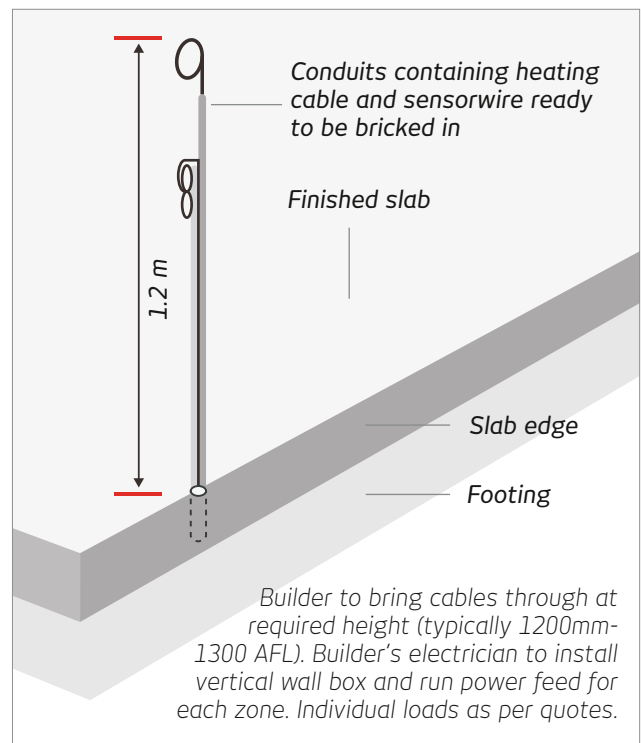

Fully installed or Floor Heating Kits

Radiant offer a fully installed service through a network of accredited installers in many parts of Australia. We also offer many of our systems in boxed 'kit' format which are sold through home improvement, bathroom and electrical stores all

over Australia – see website for details of our suppliers if you want to purchase in kit form. Radiant are more than happy to assist with specification questions, plans and drawings for both supply only as well as supply and install.

Installation: Underfloor heating mats

NOTE: Only when you have calculated that the mat will fit into the room should you begin to lay. Please use the calculator on our website to ensure you order the correct mat size.

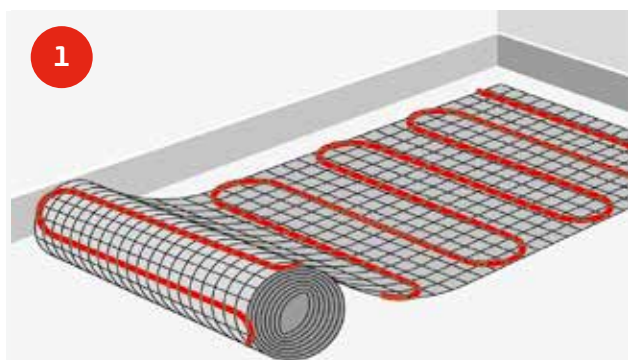

Beginning at the corner closest to where the thermostat is located, position the mat ready to start rolling out.

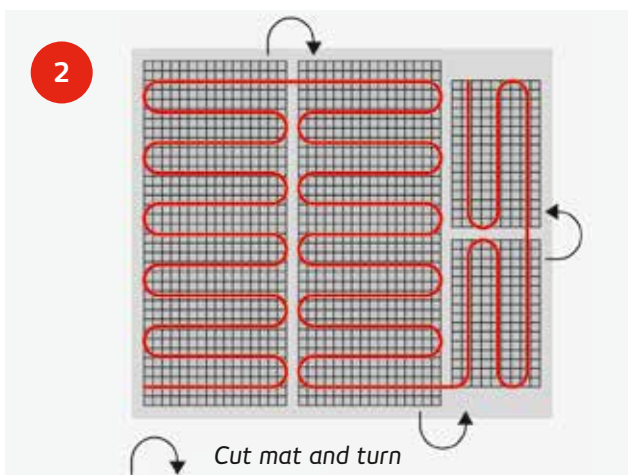

From the starting point, begin rolling out the mat

When you have done one full run and reach the opposite corner of the room cut through the mesh. DO NOT CUT THROUGH THE CABLE.

Turn the mat through 180° and roll the mat back the other way.

Continue this process until all of the mat is used up.

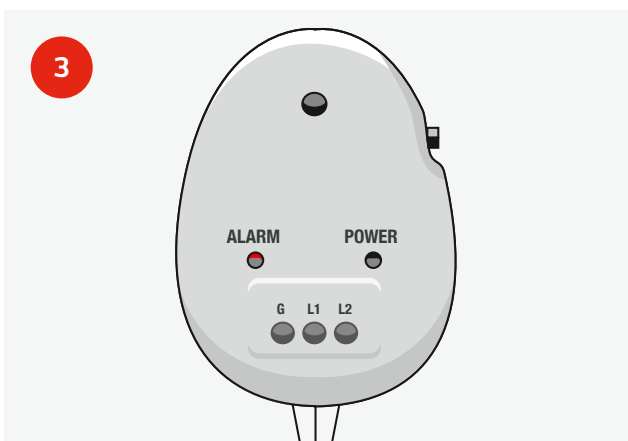

Included in your kit is a cable alarm. Connect and switch on the cable alarm prior to tiling or covering with self-levelling screed. The cable alarm must be turned on at all times when tiling or when any other trades are working in the room.

FAQs

WHAT SIZE HEATING KIT DO I NEED?

You should aim to cover between 80-95% of the free floor space of the room. Covering less than 80 % of the FFS means you may end up with cold spots on your floor. We recommend that you measure the intended area to be heated and remove 10% of your total measurement to ensure that you don't order too much. Please use the calculator on our website to ensure you order the correct mat size.

WHAT WATTAGE DO I NEED?

If you would like to heat a standard living room which is well insulated, 150 watts per sqm.

For bathrooms we always recommend using the 200 watt / sqm mats due to the limited floor space available.

IF THE HEATING CABLE IS DAMAGED CAN IT BE REPAIRED?

As long as the tiler is careful and you use the cable monitor provided, this should not happen. On the rare occasion that this might occur, Radiant Australia have a network of repair specialists that can diagnose and repair where necessary.

WHAT IS THE WARRANTY?

We offer a 10 year warranty on the heating cables/mats and a 2 year warranty on the thermostats.

WHAT MAINTENANCE IS REQUIRED?

The system is basically maintenance free as there are no moving parts to wear, apart from the thermostat, which is easy to replace.

IS THE SYSTEM SAFE?

Yes. The cable is double insulated and is IPX7 rated making it safe for wet areas.

HOW HOT DOES THE FLOOR GET?

To maintain a 21°C air temperature the floor temperature would be approximately 25°C or approximately 4°C above the desired room air temperature.

IS IT EXPENSIVE TO RUN?

How much does it cost to run is obviously one of the most common questions we get and the short answer is that it can vary quite a bit. The size and design of your home, the temperature you want to achieve and the choice of using off-peak or standard rate power will all affect the heating costs.

Whilst here in Australia, insulation levels may not be as good as many European countries where floor heating is one of the most popular forms of heating, this is usually compensated for by the fact that our external winter temperatures are in most cases, considerably higher. If you want to reduce your carbon footprint and keep heating and cooling costs to a minimum, consideration should always be given to a good solar passive design and the highest levels of insulation that are practical within your budget. Adding underslab insulation or thermasheet below screeds or tiles can reduce running costs considerably. Increasing ceiling insulation to R5 or R6 and even double glazing the windows will usually always pay for themselves over the long term. Many people are also now adding PV 'solar power' to their home design, again to reduce power bills.

Our best advice on this subject if using under floor heating as your main winter heating system would be to carefully consider using off peak power where available as this can often result in savings of close to 50% compared with standard tariffs.

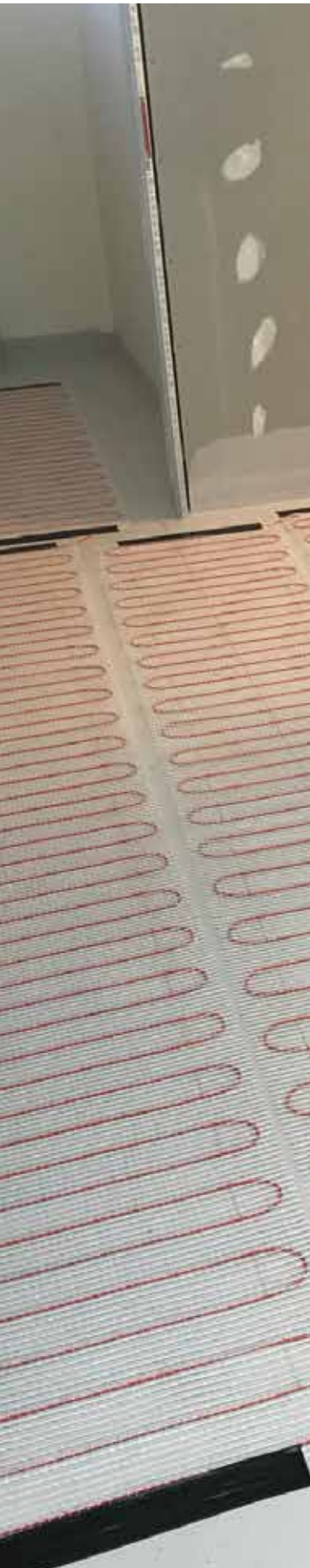

Under tile heating kit



UNDER TILE KIT INCLUDES

- 500mm wide under tile cable mat – with self-adhesive backing
- Touch screen floor/air sensing thermostat
- Floor heating sensor
- Cable alarm
- Cloth duct tape
- Under tile floor heating kit instructions

Our under-tile floor heating kit is perfect for putting floor heating under tiles, where the floor is not going to be screeded.

The cable mat is installed on the base surface and is then covered with the tile adhesive and tiles. The thin 3mm cables means that in many cases the tiler only has to use a little bit of extra adhesive. The mats are 500mm wide and are easily installed by cutting the

matting (NOT THE CABLE) and snaking the mat backwards and forwards filling in the area to be heated. NOTE where large heavy tiles are being used it is advisable to first cover the mats with a thin levelling compound to protect them. *This system is the most popular choice for bathrooms in VIC and TAS where bathrooms are generally not screeded. It is also very popular for living areas in all states.*

Underfloor heating mat kits - cable supplied pre-spaced on mat

UNDER TILE MAT KITS FOR BATHROOMS 200W/SQM

| CODE | MAT SIZE | AREA COVERAGE | HEAT OUTPUT |
|----------------|--------------------|---------------|-------------|
| UTCMK200-200W | 0.5 x 2.0m /1.0sqm | 1.2 -1.7sqm | 200 watts |
| UTCMK200-300W | 0.5 x 3.0m /1.5sqm | 1.8 - 2.2sqm | 300 watts |
| UTCMK200-400W | 0.5 x 4.0m /2.0sqm | 2.3 - 2.7sqm | 400 watts |
| UTCMK200-500W | 0.5 x 5.0m /2.5sqm | 2.8 - 3.2sqm | 500 watts |
| UTCMK200-600W | 0.5 x 6.0m /3.0sqm | 3.3 - 3.7sqm | 600 watts |
| UTCMK200-700W | 0.5 x 7.0m /3.5sqm | 3.8 - 4.2sqm | 700 watts |
| UTCMK200-800W | 0.5 x 8.0m /4.0sqm | 4.3 - 4.7sqm | 800 watts |
| UTCMK200-900W | 0.5 x 9.0m /4.5sqm | 4.8 - 5.2sqm | 900 watts |
| UTCMK200-1000W | 0.5 x 10m /5.0sqm | 5.3 - 6.3sqm | 1000 watts |
| UTCMK200-1100W | 0.5 x 11m /5.5sqm | 6 - 6.6sqm | 1100 watts |
| UTCMK200-1200W | 0.5 x 12m /6.0sqm | 6.4 - 7.5sqm | 1200 watts |
| UTCMK200-1400W | 0.5 x 14m /7.0sqm | 7.5 - 9sqm | 1400 watts |
| UTCMK200-1600W | 0.5 x 16m /8.0sqm | 9 - 10.5sqm | 1600 watts |

UNDER TILE MAT KITS FOR LIVING AREAS AND LARGE BATHROOMS 150W/SQM

| PRODUCT CODE | MAT SIZE | AREA COVERAGE | HEAT OUTPUT |
|----------------|---------------------|----------------|-------------|
| UTCMK150-900W | 0.5 x 12m/6sqm | 6.0 - 7.9sqm | 900 watts |
| UTCMK150-1050W | 0.5 x 14m/7sqm | 8.0 - 8.9sqm | 1050 watts |
| UTCMK150-1200W | 0.5 x 16m/8sqm | 9.0 - 9.9sqm | 1200 watts |
| UTCMK150-1350W | 0.5 x 18m/9sqm | 10.0 - 11.0sqm | 1350 watts |
| UTCMK150-1500W | 0.5 x 20m/10sqm | 11.0 - 12.0sqm | 1500 watts |
| UTCMK150-1650W | 0.5 x 22m/11sqm | 12.0 - 13.0sqm | 1650 watts |
| UTCMK150-1800W | 0.5 x 24m/12sqm | 13.0 - 14.0sqm | 1800 watts |
| UTCMK150-1950W | 6sqm + 7sqm/13sqm | 14.0-16.0sqm | 1950 watts |
| UTCMK150-2100W | 2 x 7sqm/14sqm | 16.0 - 17sqm | 2100 watts |
| UTCMK150-2250W | 7sqm + 8sqm/15sqm | 17.0-18.0sqm | 2250 watts |
| UTCMK150-2400W | 2 x 8sqm/16sqm | 18.0-19.0sqm | 2400 watts |
| UTCMK150-2550W | 8sqm + 9sqm/17sqm | 19.0-20.0sqm | 2550 watts |
| UTCMK150-2700W | 2 x 9sqm/18sqm | 20.0-21.0sqm | 2700 watts |
| UTCMK150-2850W | 9sqm + 10sqm/19sqm | 21.0-23.0sqm | 2850 watts |
| UTCMK150-3000W | 2 x 10sqm/20sqm | 22.0 - 24.0sqm | 3000 watts |
| UTCMK150-3150W | 10sqm + 11sqm/21sqm | 23.0 - 26.0sqm | 3150 watts |
| UTCMK150-3300W | 2 x 11sqm/22sqm | 25.0 - 27.0sqm | 3300 watts |
| UTCMK150-3450W | 11sqm + 12sqm/23sqm | 26.0-28.0sqm | 3450 watts |

* For large areas multiple kits can be used. Please contact Radiant Heating for advice.

Professional kits - cable supplied on drum

UNDER TILE CABLE KITS FOR BATHROOMS

| CODE | AREA COVERAGE | CABLE LENGTH | HEAT OUTPUT |
|----------|---------------|--------------|-------------|
| UTCK150 | 0.8 - 1.0sqm | 15m | 150 watts |
| UTCK250 | 1.3 - 1.7sqm | 25m | 250 watts |
| UTCK350 | 1.8 - 2.3sqm | 35m | 350 watts |
| UTCK450 | 2.4 - 3.0sqm | 45m | 450 watts |
| UTCK550 | 2.9 - 3.5sqm | 55m | 550 watts |
| UTCK650 | 3.6 - 4.2sqm | 65m | 650 watts |
| UTCK750 | 4.2 - 4.9sqm | 75m | 750 watts |
| UTCK900 | 5.0 - 5.9sqm | 90m | 900 watts |
| UTCK1100 | 6.0 - 7.0sqm | 110m | 1100 watts |

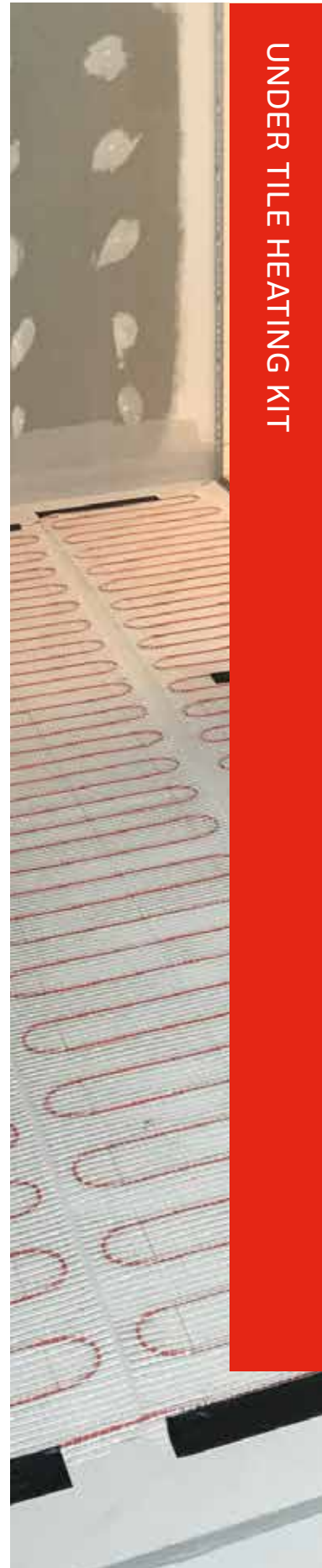

In-screed heating kit



IN-SCREED KIT INCLUDES

- In screed cable on drum or 500mm wide mat - with self adhesive backing
- Touch screen floor/air sensing thermostat
- Floor heating sensor
- Cable alarm
- Cloth duct tape
- In-screed floor heating kit instructions
- Mesh + cable tiles supplied for cable system.

For bathrooms, our in-screed cable is also pre attached to a mat in a similar fashion to the under tile kit. However, the cables are slightly thicker and robust at 7mm, and provide an easy way of laying the floor heating cable before the tiler screeds the floor.

This unique product removes a lot of the hassle of installing in-screed heating cable as it is pre-spaced on the mat and does not interfere with the normal tiling process. *This is the most popular choice for bathrooms in NSW, SA and WA where many bathrooms have a screed level done before tiling.*

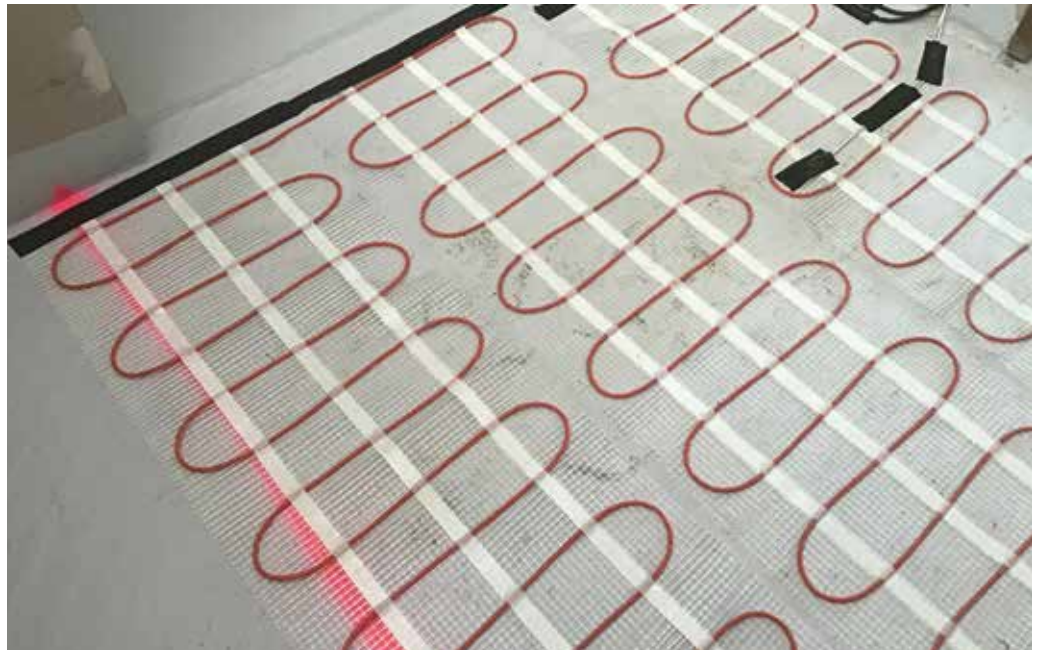
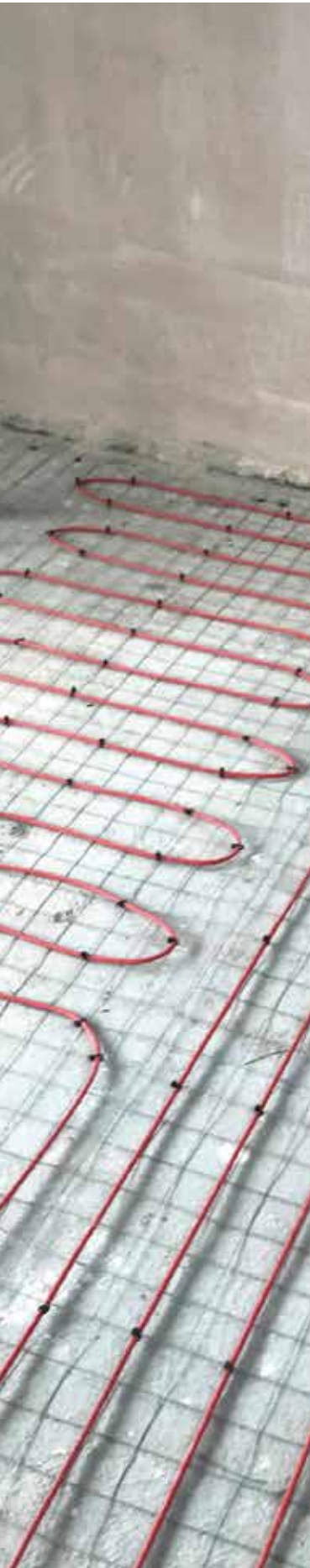

In-screed mat system

Underfloor heating mat kits - cable supplied on mats

IN SCREED MAT KITS FOR BATHROOMS 200W/SQM

| PRODUCT CODE | MAT SIZE | AREA COVERAGE | HEAT OUTPUT |
|----------------|-------------------|---------------|-------------|
| ISCMK200-200W | 0.5 x 2.0m/1.0sqm | 1.2 - 1.7sqm | 200 watts |
| ISCMK200-300W | 0.5 x 3.0m/1.5sqm | 1.7 - 2.1sqm | 300 watts |
| ISCMK200-400W | 0.5 x 4.0m/2.0sqm | 2.2 - 2.6sqm | 400 watts |
| ISCMK200-500W | 0.5 x 5.0m/2.5sqm | 2.7 - 3.2sqm | 500 watts |
| ISCMK200-600W | 0.5 x 6.0m/3.0sqm | 3.3 - 3.8sqm | 600 watts |
| ISCMK200-700W | 0.5 x 7.0m/3.5sqm | 3.9 - 4.3sqm | 700 watts |
| ISCMK200-800W | 0.5 x 8.0m/4.0sqm | 4.4 - 5.2sqm | 800 watts |
| ISCMK200-1000W | 0.5 x 10m/5.0sqm | 5.3 - 6.3sqm | 1000 watts |
| ISCMK200-1200W | 0.5 x 12m/6.0sqm | 6.4 - 7.5sqm | 1200 watts |
| ISCMK200-1400W | 0.5 x 14m/7.0sqm | 7.7-8.9sqm | 1400 watts |
| ISCMK200-1600W | 0.5 x 16m/8.0sqm | 9.0-10sqm | 1600 watts |

Professional kits - cable supplied on drum

IN SCREED MAT KITS FOR BATHROOMS

| CODE | AREA COVERAGE | CABLE LENGTH | HEAT OUTPUT |
|-----------|---------------|--------------|-------------|
| ISCK200W | 0.9 - 1.1sqm | 10m | 200 watts |
| ISCK240W | 1.2 - 1.4sqm | 12m | 240 watts |
| ISCK300W | 1.5 - 1.9sqm | 15m | 300 watts |
| ISCK400W | 2.0 - 2.4sqm | 20m | 400 watts |
| ISCK500W | 2.5 - 2.9sqm | 25m | 500 watts |
| ISCK600W | 3.0 - 3.5sqm | 30m | 600 watts |
| ISCK700W | 3.5 - 3.9sqm | 35m | 700 watts |
| ISCK800W | 4.0 - 4.5sqm | 40m | 800 watts |
| ISCK900W | 4.5 - 4.9sqm | 45m | 900 watts |
| ISCK1000W | 5.0 - 5.9sqm | 50m | 1000 watts |
| ISCK1200W | 6.0 - 6.9sqm | 60m | 1200 watts |
| ISCK1400W | 7.0 - 7.9sqm | 70m | 1400 watts |
| ISCK1600W | 8.0 - 9.9sqm | 80m | 1600 watts |
| ISCK2000W | 10 - 11.9sqm | 100m | 2000 watts |

* For large areas multiple kits can be used. Please contact Radiant Heating for advice.

IN SCREED MAT KITS FOR LIVING AREAS

| | | | |
|------------|----------|------|------------|
| ISCMK2000W | 16-19sqm | 100m | 2000 watts |
| ISCMK2400W | 19-22sqm | 120m | 2400 watts |
| ISCMK3000W | 22-28sqm | 150m | 3000 watts |

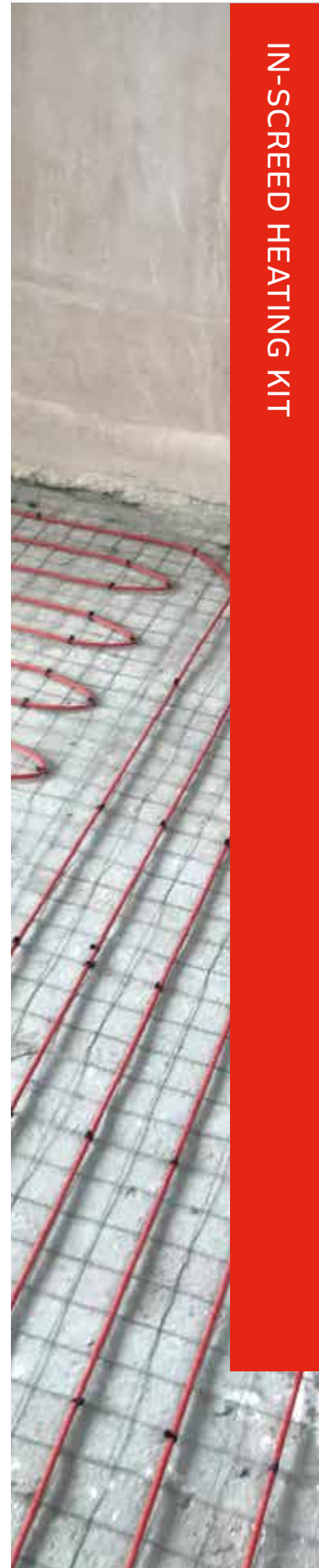

ROOM SIZE

Length (m) x Width (m)
 Total (sqm)

OPTIONS

Type: In-Slotted Under Tile

Dual Controller? Does customer also want to control a heated towel rail?

Thermostat: Style Standard Premium Orientation Vert Horiz
 Colour: White Silver Black

EXCLUSIONS

| | Length (m) | x | Width (m) | Area (sqm) |
|--------------------|----------------------------------|---|----------------------------------|--|
| Bath | <input type="text" value="2"/> | x | <input type="text" value="1"/> | <input type="text" value="2"/> |
| Shower | <input type="text" value="1"/> | x | <input type="text" value="1"/> | <input type="text" value="1"/> |
| Vanity | <input type="text" value="2"/> | x | <input type="text" value="0.5"/> | <input type="text" value="1"/> |
| Toilet | <input type="text" value="0.7"/> | x | <input type="text" value="0.7"/> | <input type="text" value="0.49"/> |
| Other | <input type="text"/> | x | <input type="text"/> | <input type="text" value="0"/> |
| Total (sqm) | | | | <input type="text" value="4.49"/> |

Other - Lengths
Enter length of
other in metres

3m x 4m

For illustrative purposes only. Not to scale. This is not an indication of how the floor heating mat should be installed. Refer to installation guide.

HEATING MAT REQUIRED

SIZE: sqm

MODEL: **ISCMK200-1400W**

DIMENSIONS: m x m

CABLE THICKNESS: mm

LOAD (Watts / Amps): W / A

CONTROLLER:

APPROX RUNNING COST (ph):

KIT INCLUDES: Self adhesive heating cable mat, cable alarm, thermostat (as above), Floor sensor, cloth tape, instructions & warranty form

ITEMS WHICH YOU NEED TO ORDER

Kit Model: **ISCMK200-1400W**
 Upgrades: **UP-GTS-UP-DUAL**
 Exchanges: **EX-5**

Calculating your project

It is important that you plan the mat layout. This is a vital step and **MUST** be done correctly to ensure that all the mat is used up. Once the mat has been unrolled and cut it cannot be returned.

It is key to measure the area to be heated in m². Do not include areas taken up by fixed objects such as baths, showers and kitchen units. If the calculated heated area is smaller than the chosen mat size **STOP** and return and exchange for the correct mat size.

To assist with this, Radiant have created an online calculator that can be easily downloaded from our website. This will calculate the exact free floor area for you, providing you with the product code that you will need for the specific kit:

<http://www.radiantheating.com.au/floor-heating-diy-calculator.html>



Dual thermostats/ timers

If you're considering installing a heated towel rail with your underfloor heating, you'll need our dual touch screen thermostat/timer. The TS8100W-TH-V thermostat (vertical mounted, white surround) is included with all our floor heating kits. In order to upgrade to one of the options below, add the upgrade code to your order.



RADIANT DIGITAL STANDARD TOUCH SCREEN THERMOSTATS/TIMERS

| CODE | MOUNTING |
|---------------|---|
| TS8100-DUAL-V | Standard Touch Screen Vertical Dual Purpose Thermostat & Timer Switch - White |

RADIANT DIGITAL GLASS FRONTED TOUCH SCREEN THERMOSTATS/TIMERS

| CODE | MOUNTING |
|------------------|--|
| GTSW-TH-V | Vertical Mounted - White |
| GTSB-TH-V | Vertical Mounted - Black |
| GTSS-TH-V | Vertical Mounted - Silver |
| GTSW-TH-H | Horizontal Mounted - White |
| GTSB-TH-H | Horizontal Mounted - Black |
| GTSS-TH-H | Horizontal Mounted - Silver |
| GTSW-TH-V-WIFI | Vertical Mounted WIFI Thermostat - White |
| GTSW-DUAL-V | Vertical Dual Purpose Thermostat & Timer Switch - White |
| GTSB-DUAL-V | Vertical Dual Purpose Thermostat & Timer Switch - Black |
| GTSS-DUAL-V | Vertical Dual Purpose Thermostat & Timer Switch - Silver |
| GTSW-DUAL-H | Horizontal Dual Purpose Thermostat & Timer Switch - White |
| GTSB-DUAL-H | Horizontal Dual Purpose Thermostat + Timer Switch - Black |
| GTSS-DUAL-H | Horizontal Dual Purpose Thermostat + Timer Switch - Silver |
| GTSW-DUAL-V-WIFI | Vertical Mounted WIFI Thermostat & Timer switch - White |
| GTSW-DUAL-H-WIFI | Horizontal Mounted WIFI Thermostat & Timer switch - White |

STANDARD



WHITE

PREMIUM



WHITE



BLACK



SILVER



VERSION 5



Radiant Australia Pty Ltd

Unit 1 / 18 Profit Pass
Wangara, WA 6065

Telephone: 08 9302 4140

Fax: 08 8490 2343

radiantaustralia.com.au

Direct dispatch from
our warehouses in
PERTH / MELBOURNE / HOBART