



Australia's Favourite  
Name In Hot Water



**RHEEM DOMESTIC HOT WATER**

AUGUST 2022

COMES ON STEADY, HOT AND STRONG

INSTALL A



**PRODUCT INFORMATION**

Why Rheem? ..... 3

Rheem Electric Storage Hot Water ..... 4

Rheem Gas Storage Hot Water ..... 6

Rheem Continuous Flow Hot Water ..... 8

Rheem Solar Hot Water ..... 10

Rheem Heat Pump Hot Water ..... 12

**PRODUCT DATA**

Rheem Electric Storage ..... 14

Rheem Electric Stainless Steel ..... 15

Rheem Gas Storage ..... 16

Rheem Gas Continuous Flow ..... 17

Rheem Solar ..... 18

Rheem Heat Pump ..... 20



**RHEEM AUSTRALIA PTY LTD**

**National Office**  
55 Brodie Street  
Rydalmere NSW 2116  
Australia

**National Sales Phone: 132 552**  
**National Service Phone: 131 031**  
**www.rheem.com.au**

**Postal**  
Australia Pty Ltd  
PO Box 7508  
Silverwater NSW 2128  
Australia  
ABN: 21 098 823 511

© Registered Trademark of Rheem Australia Pty Ltd  
™ Trademark of Rheem Australia Pty Ltd



# RHEEM IS AUSTRALIA'S FAVOURITE NAME IN HOT WATER AND THE NAME AUSTRALIANS HAVE TRUSTED FOR GENERATIONS

## YOU'LL BE RIGHT WITH RHEEM

Rheem hot water systems have been trusted for generations..... right back to 1939. Travelling through the years, the common thread that's built this trust is our level of innovation and invention: we don't just make water heaters that work – we make them work superbly.

Whether it's the unmatched recovery rate of our gas storage water heaters, or the robust materials keeping our electric water heaters working year after year, it's the quality of our design and manufacture that underpins our promise to Australian families: Hot water that comes on steady, hot and strong. Install a Rheem

## SERVICE YOU CAN RELY ON

Water heaters are, like most appliances, more and more sophisticated as the designs incorporate increased energy efficiency and user comfort. That's why at Rheem we have a national network of expert technicians and service agents who are highly trained in Rheem Australia's brands, products and services.

Rheem service technicians, service agents, and leading plumbers have an intimate knowledge of Rheem's entire product range. No matter where you are in Australia there is expert advice available to keep you in hot water.

## WE HAVE THE RIGHT RHEEM FOR YOU

Rheem has the most extensive range of hot water systems available in Australia. Solar, gas or electric storage. Continuous flow or heat pump. Energy efficient and stainless-steel options. Rheem has a range of capacities to suit your requirements and your budget. Install a Rheem.



## CHOOSING THE RIGHT CAPACITY RHEEM FOR YOUR HOME

Many households change over time, so it's important to choose the right capacity to meet your needs both now and as your family grows.

### Factors to consider in determining your hot water needs:

- Number of bathrooms or people using hot water at the same time.
- Adults and children in the home (teenagers will use more hot water than young children).
- Dishwashers or washing machines connected to hot water outlets, that may use hot water at the same time.
- Will a large bathtub or spa-bath be used regularly?
- Space available to install a water heater.
- Available energy supplies - gas or electricity.

Your hot water system needs will be influenced by the water conditions, climate and water pressure in your region, as well as the available energy supply (gas or electricity) and space available at your home.



# RHEEM ELECTRIC STORAGE HOT WATER

## RELIABLE HOT WATER FOR ALL THE FAMILY

Rheem electric storage water heaters store hot water in the tank ready for immediate use. These products rely on an electric element(s), which is controlled by a thermostat, to heat water.

Rheem large electric water heaters are ideal for use with low cost off-peak electricity, and are available in a range of capacities to suit most needs.

### WHY RHEEM ELECTRIC STORAGE?

Designed for Australia's tough conditions using over 85 years of experience manufacturing in Australia. Includes models suitable for connection to economical 'off peak', 'time or use' or continuous electricity tariffs.

Sizes to suit every family and hot water requirement from 25L to 400L models. 80 to 400L models offer 12 year cylinder warranty.<sup>2,3</sup>



Easy retrofit like for like replacement



Suitable for indoor or outdoor installation



Mains Pressure



Full Technical Support available through the Rheem National Service Network

### OFF-PEAK, TIME-OF-USE, OR CONTINUOUS ELECTRICITY?

- **Off-Peak** tariffs offer lower cost electricity during specific times, typically during the night or outside peak usage periods - ideal for large water heaters.
- **Time-Of-Use** tariffs provide power to the water heater 24 hours per day, but different rates apply at different times of day - ideal for use with smart meter and timer.
- **Continuous** tariff electricity makes power available to heat the water 24 hours per day - ideal for small water heaters.

Compare various water heater running costs online at:

<https://www.rheem.com.au/rheem/help/running-cost-calculator> or speak to your energy retailer for tariff details.



### TARIFF & CAPACITY CALCULATOR<sup>†</sup>

Single Element	People Per Household Off Peak Tariff		PPH - Continuous / Time of Use Tariff <sup>*</sup>	
	Moderate Climate	Cool Climate	Moderate Climate	Cool Climate
50L	-	-	1 ♂	1 ♂
80L	-	-	2-3 ♂	1-2 ♂
125L	2-3 ♂	1-2 ♂	3-4 ♂	2-3 ♂
160L	3-4 ♂	2-3 ♂	4-5 ♂	3-4 ♂
250L	4-6 ♂	3-5 ♂	5-8 ♂	4-6 ♂
315L	6-7 ♂	5-6 ♂	8-9 ♂	6-7 ♂
400L	7-8 ♂	6-7 ♂	8-9 ♂	7-8 ♂

<sup>\*</sup> People per household (PPH) supplied under 'Time of use' tariff conditions is equivalent to continuous tariff, provided the power supply is unrestricted.

<sup>†</sup> Calculations based on 7min shower at 42°C mixed water temperature.

Appliances using hot water should be counted as one (1) person.

- Not recommended for off peak use.



ELECTRIC



1-9  
PEOPLE



18L-400L  
CAPACITY



1,2,3  
7 or 12 YEAR  
CYLINDER  
WARRANTY



Model Number:  
111025/191045

### RHEEM COMPACT ELECTRIC

- Most compact units in their segments. Suitable where other 25L, or a 50L doesn't fit.
  - Just 390mm high (111025) & 670mm high (191045)
  - Smallest diameter on the market 385mm (111025) & 400mm (191045)
  - 47L hot water delivery.\* (191045 model)
  - Dual handed (191045) - easier to install.
  - 111025 available with lead and plug
  - 7 year cylinder warranty.<sup>1</sup>
- \* Rated hot water delivery 40L in accordance with AS/NZS 4692.1. Actual delivery 47L when tested to AS/NZS 4692.1.



Model Number:  
191 Series

### RHEEM SMALL ELECTRIC

- Available in 25L & 50L.
- Dual handed fittings.
- Front oriented fittings for easier access.
- 25L & 50L models available with lead and plug.
- 7 year cylinder warranty.<sup>1</sup>



Model Numbers:  
481/491/492 Series

### RHEEM LARGE ELECTRIC

- Available in 80L - 400L models.
- Dual handed fittings.
- Durable Rheem Ultraname<sup>®</sup> cylinder coating
- Twin element models available.
- 125 - 400L models manufactured in Australia.
- 12 year cylinder warranty.<sup>2</sup>



Model Numbers:  
4A1/4A2 Series

### RHEEM STAINLESS STEEL ELECTRIC

- Available in 50L - 315L models.
- Twin element models available.
- Up to 24% better than MEPS<sup>4</sup> reducing energy use, saving you money.
- Stainless steel cylinder & fittings.
- Up to 42% lighter<sup>5</sup> for easier handling and installation.
- No anode - saves on maintenance costs.
- Manufactured in Australia.
- 12 year cylinder warranty.<sup>3</sup>



Model Number:  
431 Series

### RHEEM DUALTEMP<sup>®</sup> ELECTRIC

- Available in 125L, 160L, 250L & 315L capacities.
- 50°C tempered and full temperature model.
- Tempered water outlet (left hand outlet), adjustable to deliver up to 50°C hot water.<sup>6</sup>
- Full temperature outlet (right hand outlet), can deliver full temperature (up to 70°C) hot water for kitchen and laundry.
- Manufactured in Australia.
- 12 year cylinder warranty.<sup>2</sup>
- Meets the requirements of AS 3498.

View the  
range online



Rheem Compact electric (191045)

Product data: page 14-15

# RHEEM GAS STORAGE HOT WATER

## QUALITY GAS STORAGE WATER HEATERS

Mains pressure gas storage water heaters deliver hot water instantly, as the tank stores a generous quantity of hot water ready for your use. Mains pressure means you can be sure of a strong flow of hot water, giving households the ability to run many hot water outlets, all at once.

A choice of 4 and 5 Star models, in a range of capacities means there is a model for every budget and family. Our Australian made models offer high recovery and will have you enjoying long hot showers.

Gas storage water heaters are rated by the storage capacity and also the "recovery rate". This is the quantity of water that can be fully reheated in one hour; the higher this rate the faster you can be back in hot water.



Designed for Australia's tough conditions



Fast hot water recovery



5 Star energy efficiency



Full Technical Support available through the Rheem National Service Network

### WHY RHEEM GAS STORAGE?

- 5 star energy rating models save you money.
- Designed for Australia's tough conditions, using over 85 years of experience in Australia.
- Fast hot water recovery of up to 200 litres per hour available.<sup>7</sup>
- Capacities to suit most family sizes and hot water requirement, starting from 90 Litres.



CAPACITY CALCULATOR (NUMBER OF PEOPLE)*			
<b>Rheem Stellar</b>	<b>850330</b>		<b>850360</b>
Moderate Climate	4-6 ♂		4-7 ♂
Cool Climate	3-5 ♂		3-6 ♂
<b>Rheem 5 Star</b>	<b>850265 &amp; 854265</b>		<b>850295 &amp; 854295</b>
Moderate Climate	3-5 ♂		4-6 ♂
Cool Climate	2-4 ♂		3-5 ♂
<b>Rheem 4 Star</b>	<b>347090</b>	<b>347135</b>	<b>347170</b>
Moderate Climate	2-4 ♂	3-5 ♂	4-6 ♂
Cool Climate	1-3 ♂	2-4 ♂	3-5 ♂
<b>Rheem Indoor</b>	<b>800135</b>		<b>800170</b>
Moderate Climate	3-5 ♂		4-6 ♂
Cool Climate	2-4 ♂		3-5 ♂
<b>Rheem 340</b>	<b>8A0340</b>		
Moderate Climate	4-7 ♂		
Cool Climate	3-6 ♂		

\* Calculations based on 7min shower at 42°C mixed water temperature, and thermostat at maximum setting. Appliances using hot water should be counted as one (1) person.



GAS



2-6  
PEOPLE



190L-360L FIRST  
HOUR CAPACITY



8,9,13  
10 or 12 YEAR  
CYLINDER  
WARRANTY



Model Number:  
850 Series

### RHEEM STELLAR®

- 5 Star energy efficiency.
- High recovery 200L/hour of hot water.<sup>7</sup>
- Mains pressure to multiple taps.
- 330L or 360L first hour delivery of hot water.<sup>7</sup>
- Modern design to complement any home.
- 10 year cylinder warranty.<sup>8</sup>



Model Number:  
850/854 Series

### RHEEM 5 STAR

- 5 Star energy efficiency.
- Mains pressure to multiple taps.
- Strong recovery: 275L or 305L first hour delivery of hot water<sup>7</sup>
- 10 year cylinder warranty.<sup>8</sup>

### RHEEMPLUS®

- 50°C temperature limited models.
- Separate tempering valve not required, for domestic use.<sup>10</sup>
- Adjustable to deliver 50°C at the first outlet (complying with AS 3498).



Model Number:  
347 Series

### RHEEM 4 STAR

- 90L, 135L and 170L capacities.
- 4 Star energy efficiency.
- 135L and 170L available in natural gas and propane.
- Mains pressure to multiple taps.
- Hi-temp thermostat, so you need less hot water.<sup>11</sup>
- 10 year cylinder warranty.<sup>8</sup>



Model Number:  
800 Series

### RHEEM INDOOR

- 135L and 170L capacities.
- Mains pressure to multiple taps.
- Designed to be installed indoors.
- 10 year cylinder warranty.<sup>8</sup>



Model Number:  
8A0340

### RHEEM 340 STAINLESS STEEL

- 5 Star energy efficiency.
- Stainless steel cylinder.
- Mains pressure to multiple taps.
- 185L/hour hot water recovery<sup>12</sup> - enough for large families.
- Convenient top outlet.
- Natural gas.
- 12 year cylinder warranty.<sup>13</sup>

View the  
range online



# RHEEM CONTINUOUS FLOW HOT WATER

## CONTINUOUS HOT WATER WHEN YOU NEED IT

Continuous Flow gas water heaters deliver hot water that will never run out because they heat water when you need it, for as long as you need it.

Continuous Flow water heaters work differently from storage water heaters, only heating on demand rather than heating and storing water until needed. Mounted to the wall and taking up less space, they are ideal for a compact home site or apartment.

## 6 Star energy efficient Rheem Continuous Flow for hot water that never runs out.



6 Star energy efficiency



Hot water that never runs out



Small footprint saving space



Rheem EZiSET® app, controlling your hot water has never been easier

### FACTORS TO CONSIDER IN DETERMINING YOUR HOT WATER NEEDS:

- Number of bathrooms or people using hot water at once.
- Adults and children in the home (teenagers will use more hot water than young children).
- Your needs may also depend on the climate and water pressure. The following guide can assist you in selecting the right Rheem Continuous Flow model for your home.

#### CAPACITY CALCULATOR - RHEEM 12-26L & 27L

Model	Rheem 12	Rheem 16	Rheem 20	Rheem 26	Rheem 27
Hot Water Flow Rate (@ 25°C Temp Rise) <sup>14</sup>	12L/Min	16L/Min	20L/Min	26L/Min	27L/Min
<b>Number of Bathrooms</b>					
Moderate Climate	1	1.5	2	2.5	3
Cool Climate	1	1	1.5	2	2.5

#### CAPACITY CALCULATOR - RHEEM PRONTO 12L & 16L

Model	Rheem Pronto 12	Rheem Pronto 16
Hot Water Flow Rate (@ 25°C Temp Rise) <sup>14</sup>	12 L/Min	16 L/Min
<b>Number of Bathrooms</b>		
Moderate Climate	1	1.5
Cool Climate	1	1

### DESIGNED TO DISAPPEAR

Your Rheem Continuous Flow water heater can be neatly hidden away to save even more space.\*

Pipe covers in matching colour will conceal pipework. Recess boxes will set your Rheem continuous flow into the wall.

\* Subject to pipe routing and building design.







GAS  
CONTINUOUS  
FLOW



1-6  
PEOPLE



12L-27L<sup>14</sup>  
PER MINUTE



10 YEAR HEAT  
EXCHANGER  
WARRANTY<sup>16</sup>



Model Number:  
876, 874 Series

### RHEEM GAS CONTINUOUS FLOW 12-26L

- Sizes to suit every home, apartment or family – 12L, 16L, 20L and 26L/minute capacities.<sup>14</sup>
- Rheem EZiSET app compatible
- Rheem Q Factor™ for rapid hot water every time, without the fluctuation when multiple taps demand hot water.
- 10 year heat exchanger warranty.<sup>16</sup>



Model Number:  
876, 874 Series

### RHEEM GAS CONTINUOUS FLOW 27L

- 27L/minute capacity.<sup>14</sup>
- Rheem EZiSET app compatible.
- Rheem Q Factor™ for rapid hot water every time, without the fluctuation when multiple taps demand hot water.
- Internal model available, with matched flue system.
- 10 year heat exchanger warranty.<sup>16</sup>



Model Number:  
834012 / 834016

### RHEEM PRONTO 12 & 16L

- Up to 6 Star energy efficiency to help save on gas bills.
- 12L or 16L/minute capacity.<sup>14</sup>
- No electrical connection required.
- Same mounting and connection points as most common mechanical water heaters, for fast and easy installation.
- Adjustable by the installer to 45°C or 50°C.<sup>17</sup>
- Optional Heat Shield, where required by regulation.
- 10 year heat exchanger warranty.<sup>16</sup>

### WITH RHEEM YOU'RE IN CONTROL

Rheem delivers added safety by putting you in control of the hot water in your home.

#### Rheem EZiSET® app

Set your ideal bath temperature and water level with your Smartphone. Optional Rheem EZiSET (052310) available. Uses the security and superior signal strength of your home WiFi and powerline network.



### WHY RHEEM CONTINUOUS FLOW?

**Sizes to suit every home, apartment or family**  
12L, 16L, 20L, 26L, and 27L/minute capacities.<sup>14</sup>

**Rheem EZ LINK®** delivers up to 54L/minute by linking 2 Rheem units to act as one, thereby doubling capacity.<sup>14</sup>

**Flamesafe®** **overheat protection**, which automatically shuts down your heater should it overheat.

**Factory pre-set 50°C models available**, means no separate tempering valve is required.<sup>15</sup>

**Full technical support** through Rheem's National Service Network.

**Available to suit either Natural Gas or Propane.**

Product data: page 17



View the  
range online

**Rheem Standard Electronic Temperature Controllers** are optional on all Continuous Flow models, allowing you to choose the exact temperature you need. Rheem Bathroom Controllers can be set up to 50°C.



# RHEEM SOLAR HOT WATER

## HOT WATER POWERED BY THE SUN

### WHY RHEEM SOLAR?

**Energy efficient** - can save up to 65% of water heating energy consumption.<sup>18</sup>

**Reduces carbon emissions** - solar systems can currently save up to 1.0 to 2.5 tonnes of greenhouse gas emissions per annum.<sup>18</sup>

**Complete range** - the Rheem solar range includes both split, ground mounted systems and complete roof mounted models in a variety of capacities from 180 - 410 Litres.

**All weather protection** - Rheem Premier® Loline series feature unique, drain-back heat exchange technology, that prevents the solar system from freezing, or overheating during weather extremes.

**Booster options** - Rheem solar systems are available with electric or gas boosting, providing hot water during cloudy or rainy weather.



Frost protected models available



Energy Efficient



Back-up element provides hot water during periods of low solar gain



Models available suitable for harsh water conditions

### HOW SOLAR WORKS

Solar water heaters work by absorbing energy from the sun's rays on the roof mounted solar collectors and transferring it to heat the water stored in the tank.

### DIRECT SOLAR WATER HEATING

Rheem solar ground mounted system shown

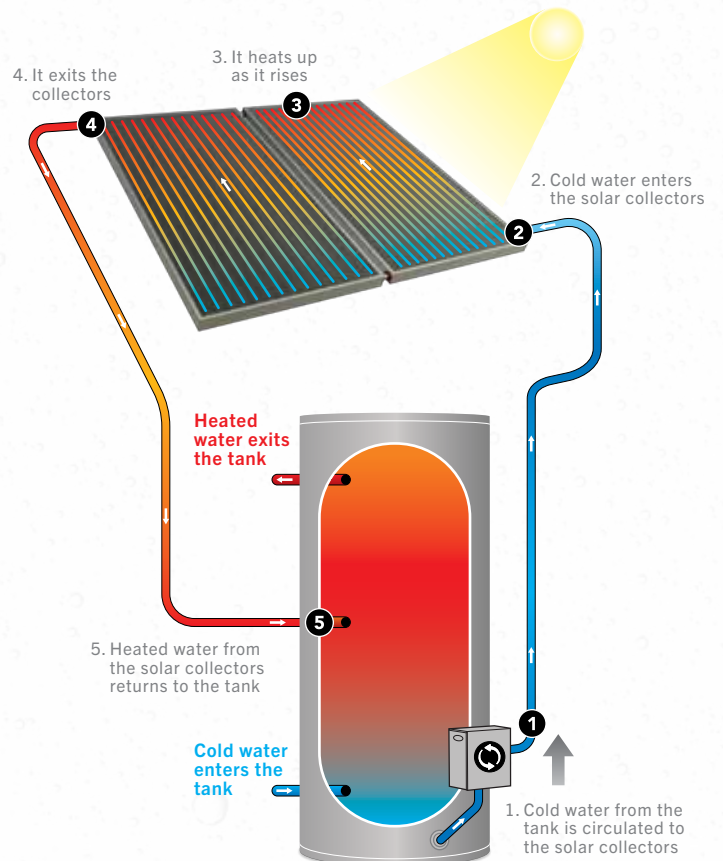

Rheem solar roof mounted system



SOLAR



1-7  
PEOPLE



160L-410L  
CAPACITY



19,28  
5 or 7 YEAR  
CYLINDER  
WARRANTY



Model Number:  
591270/2SP

### PREMIER LOLINE - ELECTRIC BOOSTED

- Indirect design with full freeze protection - ideal for even the coldest of climates.
- Features drain-back heat exchange technology, to maximise solar gain and protect against weather extremes.
- The split design reduces the structural load on your roof.

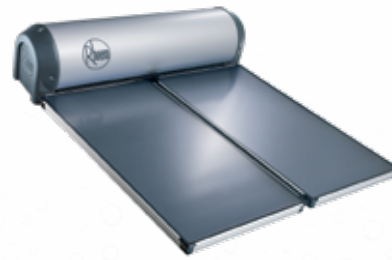

Model Number:  
52H300/2SP

### PREMIER HILINE

- Features an indirect heat exchange design, suitable for use in areas subject to freezing conditions.
- Lightweight and durable stainless steel tank cylinder (52H Series).
- Space saving roof mounted installation.
- Suitable for use with a wide range of water chemistries (52C Series).



Model Number:  
596270/2SP

### PREMIER LOLINE - GAS BOOSTED

- Designed for very cold climates and all-weather conditions and areas with harsh water chemistry
- Full freeze protection - unique Drain-Back heat exchange Falling Film Technology.
- Integrated continuous flow gas booster provides backup during periods of low or no solar gain.
- The split design reduces the structural load on your roof.



Model Number:  
52D300/2NPT

### HILINE

- Ideally suited to warmer climates with good water chemistry.
- 52D series does not have freeze protection.
- Does not require pumps and controllers.
- Relies on water moving through the solar collectors and into the tank using energy absorbed from the sun.



Save through **Small-scale Technology** Page  
**Certificates** government incentive.<sup>20</sup> 13



Model Number:  
511325/2NPT

### LOLINE

- Automatic electronic controls for solar energy gain and circulating freeze protection.
- Booster - electric element or 6 Star continuous flow gas boost back up, for when the sun isn't shining.
- Limited frost protection.
- Suitable with NPT or LCS collector.

View the  
range online



Product data: page 18-19

# RHEEM HEAT PUMP HOT WATER

## RENEWABLE HOT WATER 365 DAYS A YEAR

Traditionally solar water heaters have proven themselves to be an energy efficient renewable water heating alternative to gas and electric systems. And while solar systems continue to be an efficient way to heat water, heat pump water heating technology also saves on energy consumption and greenhouse gas emissions.

### WHY RHEEM HEAT PUMP?

**Energy efficient** - can save on energy use and greenhouse gas emissions by up to 68%.<sup>21</sup>

**No solar collectors** - ideal where roof space is limited or not facing in a suitable direction.

**Replacement for electric water heaters** - uses similar plumbing and electrical connections as an electric water heater, making it an ideal upgrade from a standard electric water heater. (*minor modifications to plumbing or electrical connections may be required*).



**Works day & night**  
Heat Pumps draw heat from the surrounding air to heat the water



**Back-up element**  
Provides hot water even in very cold conditions



551270 is suitable for cold and frost climates



551270 Coefficient of Performance (COP)<sup>22</sup> of 4.5 making it a high efficiency water heater

### HOW A HEAT PUMP WORKS

Heat Pumps use the heat from the surrounding air to heat your water. They work all year round, day or night, in sunshine or rain and even on cooler days, as there is always heat in the atmosphere which can be used.

### HEAT PUMP WATER HEATING

Rheem Ambiheat 551270 shown

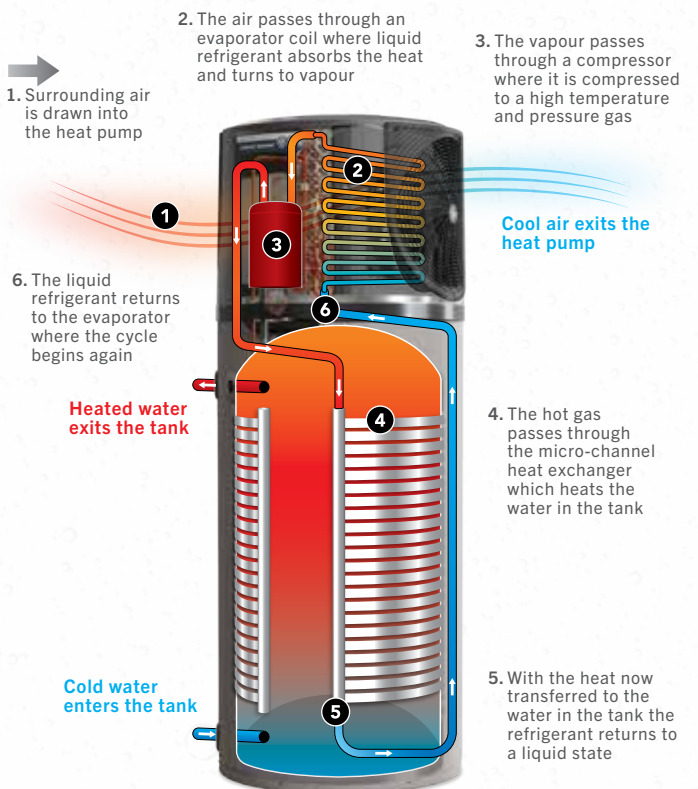



HEAT PUMP



2-5  
PEOPLE



270L-325L  
CAPACITY



25,27  
5 & 7 YEAR  
CYLINDER  
WARRANTY



Model Number:  
551270

### RHEEM AMBIHEAT

- Advanced wrap-around micro-channel heating technology for uniform and faster water heating.
- Suitable for cold climates with an operating range from -5°C to 43°C.<sup>23</sup>
- Suitable for harsh water conditions.<sup>24</sup>
- Can save up to 68% on your water heating energy consumption compared to an electric water heater in Zone 3.<sup>21</sup>
- High recovery rate for fast heating and 2.4kW back-up element for very cold conditions.
- Eligible for Government incentives<sup>20</sup>
- 7 year cylinder warranty.<sup>25</sup>



Model Number:  
551325

### RHEEM MPI SERIES II

- Ideal upgrade for an electric storage water heater, featuring common plumbing and electrical connections.
- Can connect to economical extended off-peak tariffs for maximum savings on running costs.<sup>26</sup>
- Whisper technology enables quieter operation.
- Heat Pump module is located well below the fence line, which keeps noise away from windows.
- Two piece interconnecting design allows for easy one-person installation.
- Suitable for warm and tropical climates. Not available in Tasmania.
- 5 year cylinder warranty.<sup>27</sup>



Save through **Small-scale Technology Certificates** government incentive.<sup>20</sup>

View the range online



Product data: page 20

## SMALL-SCALE TECHNOLOGY CERTIFICATES (STCs)

Small-scale Technology Certificates (STCs) provide a financial incentive to encourage the installation of Solar and Heat Pump water heaters provided under a Federal Government legislated scheme. Your installation may be eligible.<sup>20</sup> For more information visit: [www.rheem.com.au/rheem/help/offers-and-incentives/stcs](http://www.rheem.com.au/rheem/help/offers-and-incentives/stcs)

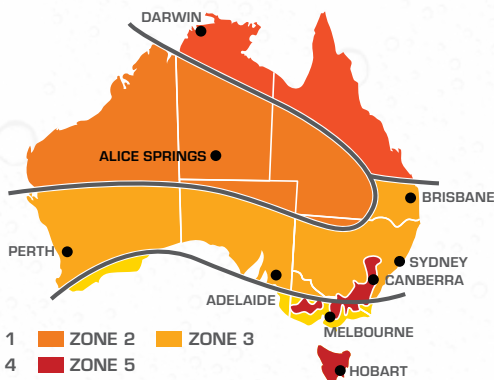

### ELIGIBILITY CRITERIA

- This map shows the climate Zones within Australia which will define the number of STCs allocated to an approved Heat Pump water heater. The country is divided into climate zones for STC creation: 4 for solar and 5 for heat pumps.
- STCs can only be created for the installation of Solar and Heat Pump water heaters listed on the Clean Energy Regulator's Registers of Solar Water Heaters and Heat Pump Water Heaters.
- The right to create STCs can only be assigned by the owner of the system and created by a Registered Agent. Note: The right to create STCs can be assigned directly to Rheem.



# RHEEM ELECTRIC STORAGE PRODUCT DATA

## PRODUCT SPECIFICATION - RHEEM ELECTRIC 25L -400L

		25	25	45	50	80	125	160	250	315	400
Rheem Single Element		111025	191025	191045	191050	481080	491125	491160	491250	491315	491400
Available with lead & plug		111025/P	191025/P		191050/P	-	-	-	-	-	-
Rheem Twin Element		-	-	-	-	-	-	492160	492250	492315	492400
Rheem DualTEMP Single Element		-	-	-	-	-	431125	431160	431250	431315	-
Warranty	years	7 years <sup>1</sup>					12 years <sup>2</sup>				
Hot Water Delivery	Litres	21	25	47**	50	91	125	160	250	315	400
Storage Capacity	Litres	25	29	50	53	96	135	165	270	325	410
Boost Capacity Twin Element		-	-	-	-	-	-	45	50	50	90
Dimensions											
A	mm	390	430	670	695	945	1340	1610	1395	1640	1840
B	mm	385	400	400	400	460	480	480	640	640	690
C	mm	420	436	436	436	496	515	515	680	680	735
D	mm	130	106	347	397	515	1102	1332	1117	1317	1479
E	mm	116	142	142	142	195	64	104	73	113	121
F	mm	75	60	60	80	122	66	66	103	103	105
G	mm	-	-	-	-	-	-	1081	988	1228	1323
H	deg	26	26	26	26	22	24	23	32	32	30
J	deg	65	64	59	59	60	60	58	88	88	83
K	mm	-	-	-	-	-	545	-	705	705	-
L	mm	-	-	-	-	-	183	183	262	262	-
M	deg	-	-	-	-	-	-	-	92	92	97
Approx. Weight Shipped	kg	17	19	25	26	36	52	60	82	97	120

Rheem 111025 models have left hand connections only.  
 191, 481, 491 & 492 Series Rheem models have left and right hand connections.  
 160 to 400 models have TPR valve fitting on the left hand side only.  
 \*\* Rated hot water delivery is 40L in accordance with AS/NZS 4692.1. Actual hot water delivery is 47L when tested for AS/NZS 4692.1

All technical data is subject to change

### RHEEM ELECTRIC 25L - 125L

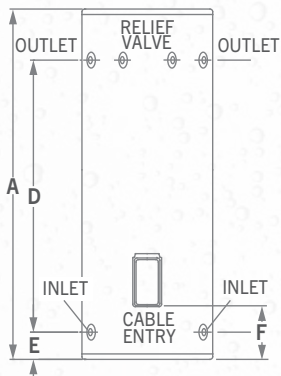

### RHEEM ELECTRIC 160L - 400L

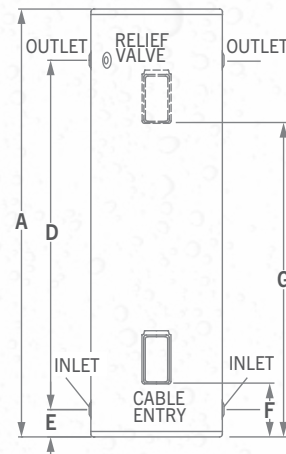

### RHEEM DUALTEMP 125L - 315L

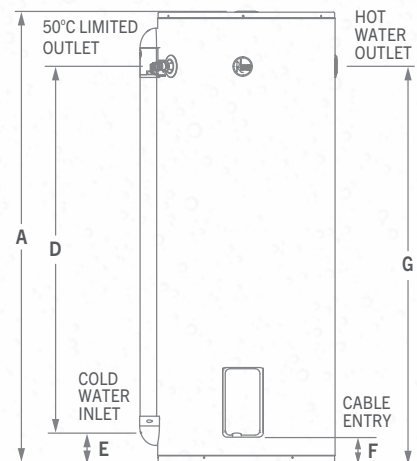

#### 25L - 125L

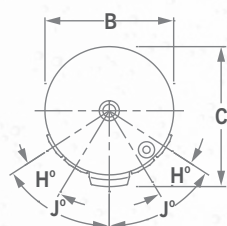

#### 160L

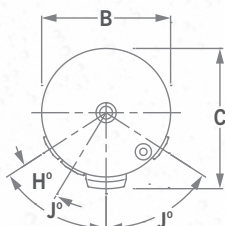

#### 250L - 400L

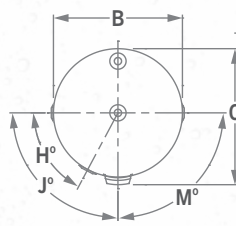

#### 125L & 160L

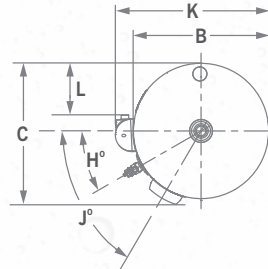

#### 250L & 315L

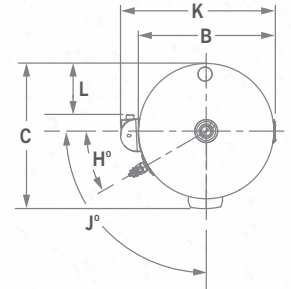

NOTE: LEFT HAND CONNECTIONS  
 RHEEM 25L (111025 only)

# RHEEM ELECTRIC STORAGE STAINLESS STEEL PRODUCT DATA

## PRODUCT SPECIFICATION - RHEEM ELECTRIC STAINLESS STEEL 50L-315L

		50	80	125	160	250	315
Single Element		4A1050	4A1080	4A1125	4A1160	4A1250	4A1315
Twin Element						4A2250	4A2315
Warranty (years)		12 years <sup>3</sup>					
Hot Water Delivery	Litres	50	80	125	160	250	315
Storage Capacity	Litres	54	80	135	165	270	324
Boost Capacity Twin Element		-	-	-	-	52	62
Better than MEPs by		4.8%	24%	17%	12%	19%	17%
<b>Dimensions</b>							
A	mm	695	885	1295	1615	1440	1760
B	mm	400	490	490	490	620	620
C	mm	432	500	500	500	630	630
D	mm	385	510	920	1240	990	1310
E	mm	145	185	185	185	230	230
F	mm	83	120	110	110	145	145
G	mm	-	-	-	-	939	1207
H	deg	30	25	25	25	30	30
J	deg	60	55	55	55	60	60
M	mm	-	125	125	125	120	120
Approx. Weight Shipped	kg	16	23	31	37	45	54

All technical data is subject to change

### RHEEM ELECTRIC STAINLESS STEEL 50L

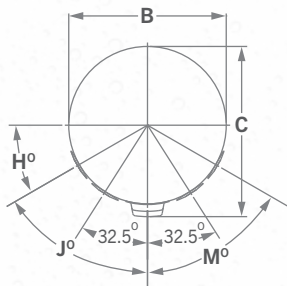
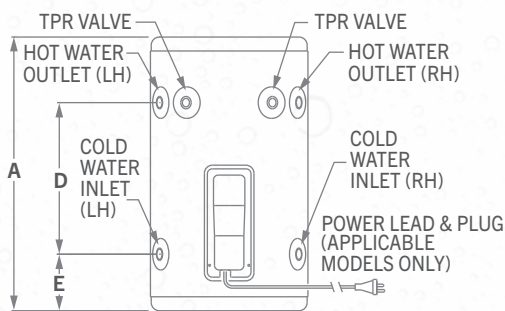

### RHEEM ELECTRIC STAINLESS STEEL 80L - 315L

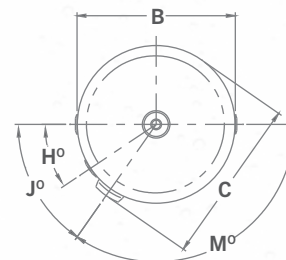
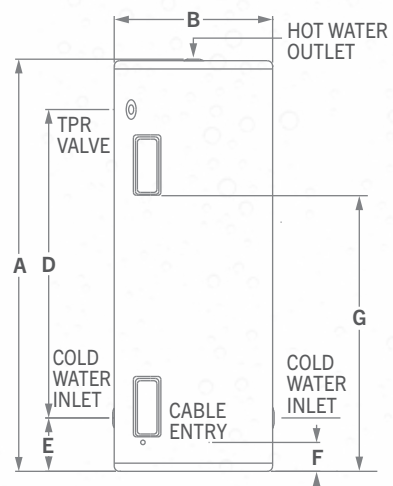

# RHEEM GAS STORAGE PRODUCT DATA

PRODUCT SPECIFICATION - RHEEM GAS STORAGE										
MODEL	Rheem 4 Star			Rheem 5 Star		Rheem Stellar		Rheem Indoor		Rheem 340 SS
	90	135	170	265	295	330	360	135	170	340
Model Number	347090	347135	347170	850265	850295	850330	850360	800135	800170	8A0340
RheemPlus®	-	-	-	854265	854295	-	-	-	-	-
Installation Type	External	External	External	External	External	External	External	Internal	Internal	External
Number of People:	Moderate Climate	2-4	3-5	4-6	3-5	4-6	4-7	3-5	4-6	4-7
	Cool Climate	1-3	2-4	3-5	2-4	3-5	3-6	2-4	3-5	3-6
Warranty (years)	10 years <sup>8,9</sup>									12 years <sup>13</sup>
Gas Type	Natural Gas	Natural Gas Propane		Natural Gas		Natural Gas		Natural Gas Propane	Natural Gas	Natural Gas
Gas Energy Rating (Stars)	4.0	4.0	4.1	5.3	5.3	5	5	3	3	5
Storage Capacity (Litres)	90	135	170	130	160	130	160	135	170	155
Recovery Rate (L/Hour@45°C)	100	113	113	145	145	200	200	120	126	185
First Hour Capacity (Litres)	190	248	283	275	305	330	360	255	296	340
Hourly Gas Consumption (MJ/Hr) Nat/Prop	25/na	27/26	27/26	30/na	30/na	42/na	42/na	30/30	30/na	40/na
Dimensions (mm)										
A	1168	1568	1868	1600	1900	1600	1900	1615	1915	1635
B	422	422	422	490	490	485	485	425	425	520
C	502	502	502	556	556	558	558	500	500	610
D	588	988	1213	988	1213	988	1213	988	1213	330
E	328	328	403	332	407	328	409	328	403	360
F	298	298	298	302	302	298	298	297	297	840
G	-	-	-	605	605	770	770	1490	1790	415
H (Rheem 340 SS Only)	-	-	-	-	-	-	-	-	-	52
H (RheemPlus® Only)	-	-	-	545	545	-	-	-	-	-
J (RheemPlus® Only)	-	-	-	182	182	-	-	-	-	-
K	473	473	473	528	528	520	520	490	490	-
L	208	208	208	240	240	252	252	213	213	-
M	-	-	-	300	300	299	299	-	-	-
N	-	-	-	95	95	93	93	-	-	-
Approx. Weight Shipped (kg)	53	69	80	90	100	87	101	56	65	65
Relief Valve Setting (kPa)	1400			1400		1400		1400		1400
Expansion Control Valve Setting (kPa)	1200			1200		1200		1200		1200
Max Water Supply Pressure:	with ECV (kPa)			960		960		960		960
	without ECV (kPa)			1120		1120		1120		1120
Water Connections	Rp ¾			Rp ¾		Rp ¾		Rp ¾		Rp ¾
Water Inlet Connection Rheem 340 LHS	-			-		-		-		Rp ¾
Water Outlet Connection Rheem 340 TOP	-			-		-		-		Rp ½
Water Connections (RheemPlus)	-			G¾B		-		-		-
Gas Connection	Rp ½			Rp ½		Rp ½		Rp ½		Rp ½

All technical data is subject to change

## RHEEM 4 STAR / 5 STAR / STELLAR / INDOOR

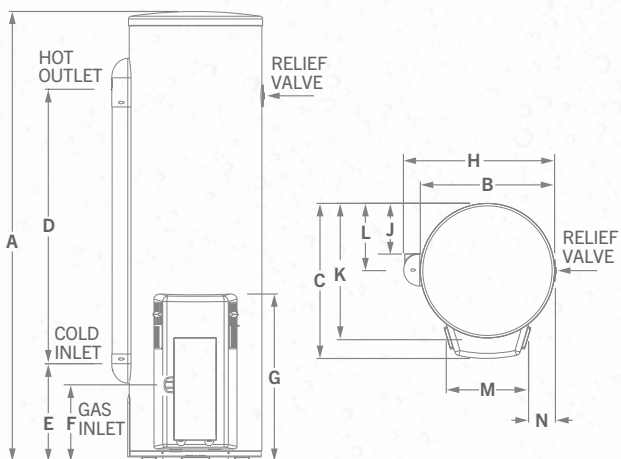

## RHEEM 340 GAS SS

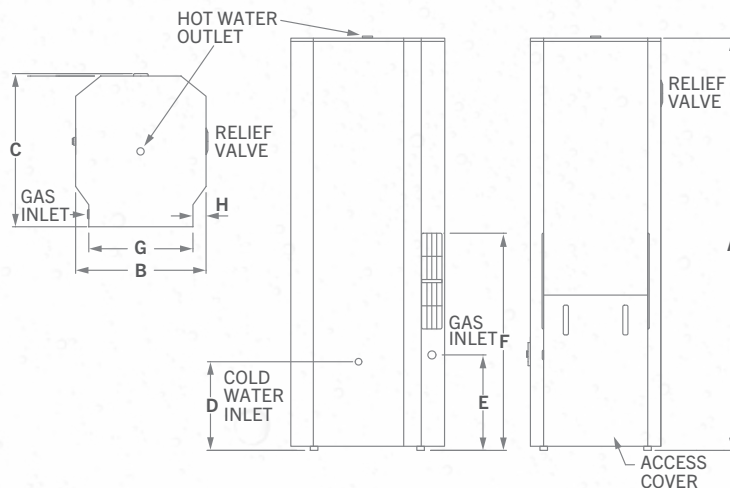



# RHEEM GAS CONTINUOUS FLOW PRODUCT DATA

## PRODUCT SPECIFICATION - RHEEM CONTINUOUS FLOW 12-26, 27, RHEEM PRONTO 12,16

MODEL	Rheem 12		Rheem 16		Rheem 20		Rheem 26		Rheem 27		Rheem 27 Internal		Rheem Pronto 12	Rheem Pronto 16
Model Number	876812	874812	876T16	874T16	876820	874820	876T26	874T26	876627	874627	866627	864627	834012	834016
Maximum Temperature °C	50	60	50	60	50	60	50	60	50	60	50	60	60	60
Number of Bathrooms	1		1 - 1.5		1.5 - 2		2 - 2.5		2.5 - 3		2.5 - 3		1	1 - 1.5
Gas Type	Natural Gas / Propane										Natural Gas		Natural Gas / Propane	
Gas Energy Rating (Stars)	6.0		6.0		6.0		6.0		6.0		6.0		6.0	5.9/5.8
Flow Rate L/Min at 25°C Rise <sup>14</sup>	12		16		20		26		27		27		12	16
Min Operating Flow Rate L/min	2.0		2.0		2.0		2.0		2.0		2.0		3.0	3.0
Nominal Gas Consumption MJ/Hr	94		126		157		199		205		205		99/96	128/125
Dimensions														
A - Height mm	520		520		520		520		600		650		840	875
B - Width mm	355		355		355		355		350		350		388	443
C - Depth mm	187		187		187		187		226		250		285	285
Depth – from wall to H/W Outlet	87		87		87		87		84		107		69	69
Depth – from wall to C/W Inlet	68		68		68		68		64		86		69	69
Depth – from wall to Gas Inlet	77		77		77		77		97		119		55	48
Weight (empty) kg	16		16		16		16		23		24		21	25
Max. Water Supply Pressure kPa	1000		1000		1000		1000		1000		1000		800	800
Min. Water Supply Pressure kPa	120		120		120		120		140		140		120 <sup>33</sup>	140 <sup>33</sup>
Cold Water Connection	R ¾		R ¾		R ¾		R ¾		R ¾		R ¾		R ½	R ½
Hot Water Connection	R ¾		R ¾		R ¾		R ¾		R ¾		R ¾		R ½	R ½
Gas Connection	R ¾		R ¾		R ¾		R ¾		R ¾		R ¾		Rp ¾	Rp ¾
Temperature Controllers														
Kitchen	299850		299850		299850		299850		299850		299850		-	-
Bathroom 1	299851		299851		299851		299851		299851		299851		-	-
Bathroom 2	299852		299852		299852		299852		299852		299852		-	-
Accessories														
Pipe Cover	299426		299426		299426		299426		299425		"Rheem 27 Internal must only be installed using certified Rheem coaxial flue components. Do not use any other type of flue system."		-	-
Recess Box*	299427		299427		299427		299427		299831		-		-	-
Rheem EZ Link Kit	299291		299291		299291		299291		299291		-		-	-
Wall Mount Security Kit	299868		299868		299868		299868		299868		-		-	-
Security Cage	299867		299867		299867		299867		299867		-		-	-
Flue Diverter (Standard)*	299287		299287		-		299287		-		-		-	-
Flue Diverter (Extended)*	-		-		-		299285		-		-		-	-
Heat Shield (Pronto Only)	-		-		-		-		-		-		299880	299880
Rheem EZiSET® kit - 052310	Suitable for models: Rheem 12 (876812), Rheem 16 (876T16), Rheem 20 (876820), Rheem 26 (876T26), Rheem 27 (876627, 876027, 866627, 866027). Suitable for Rheem 12-26L manufactured since 2018, and all Rheem 27L models.													

\*Natural gas model only  
All technical data is subject to change

### RHEEM CONTINUOUS FLOW 12 - 26L & 27L

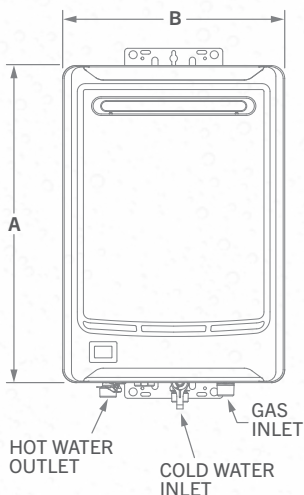

### RHEEM PRONTO 12 & 16L

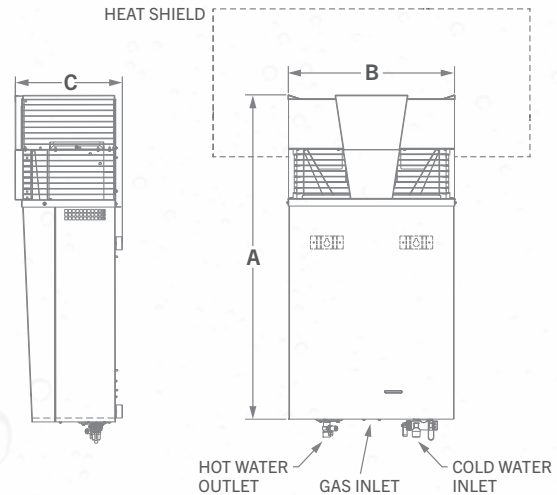

# RHEEM SOLAR PRODUCT DATA

## PRODUCT SPECIFICATION - RHEEM PREMIER® HILINE SOLAR HOT WATER HEATER - ELECTRIC AND GAS BOOSTED

MODEL		VITREOUS ENAMEL <sup>19</sup>		STAINLESS STEEL TANK <sup>28</sup>			
MODEL - Electric Boosted		52C300 / 2NPT		52H180 / 1SP		52H300 / 2SP	
MODEL - Gas Boosted		52C300 / 2NPT-G		52H180 / 1SP-G		52H300 / 2SP-G	
Storage Capacity	Litres	300		180		300	
Solar Collectors		2		1		2	
Booster Type		Electric	Gas -remote	Electric	Gas -remote	Electric	Gas -remote
Boost Capacity	Litres	150	26L/min	90	26L/min	150	26L/min
People Per Household		2-5	2-5	1-2	1-3	2-5	2-5
Dimensions & Specifications							
Height (A)	mm	2480		2520		2520	
Width (B)	mm	2425		1495		2198	
Depth (C)	mm	510		563		563	
Weight Empty – Tank	kg	110		54		81	
Weight Full – Tank	kg	410		231		377	
Weight Empty – Solar Collectors	kg	72		50		100	
Weight Full – Solar Collectors	kg	75		54		108	

## PRODUCT SPECIFICATION - RHEEM HILINE® SOLAR HOT WATER HEATER<sup>19</sup>

MODEL		GAS BOOSTED		ELECTRIC BOOSTED		
MODEL		52D180/1NPT-G		52D300/2NPT-G		
Storage Capacity		Litres	160	300	160	300
Solar Collectors		NPT200	1	2	1	2
Booster Type			Gas – Remote	Gas – Remote	Electric	Electric
Boost Capacity		Litres	26L/min	26L/min	80	160
People Per Household			1-3	2-5	1-2	2-5
Dimensions & Specifications						
Height (A)	mm	2480	2480	2480	2480	2480
Width (B)	mm	1595	2410	1595	2410	2410
Depth (C)	mm	510	510	510	510	510
Weight Empty – Tank	kg	60	92	60	92	92
Weight Full – Tank	kg	240	392	240	392	392
Weight Empty – Solar Collectors	kg	36	72	36	72	72
Weight Full – Solar Collectors	kg	38	75	38	75	75

All technical data is subject to change

### RHEEM PREMIER® HILINE SOLAR HOT WATER HEATER

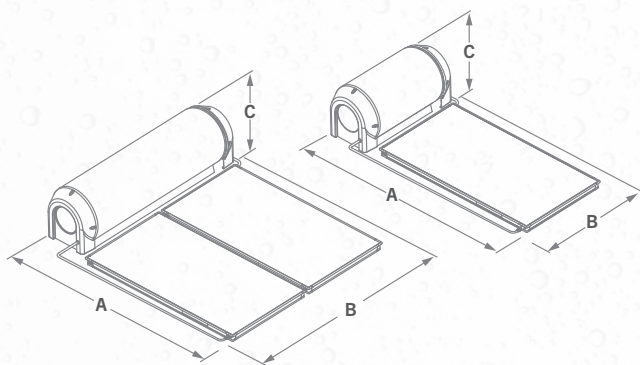

### RHEEM HILINE® SOLAR HOT WATER HEATER

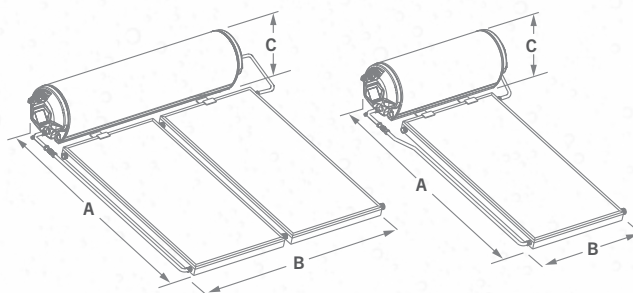

#### DIMENSIONS

MODEL	NPT200 LCS	CSA2007 SPA2000
Width (F) mm	1023	1043
Height (G) mm	1941	1996
Depth (H) mm	83	82

All technical data is subject to change

#### RHEEM SOLAR COLLECTOR MODELS

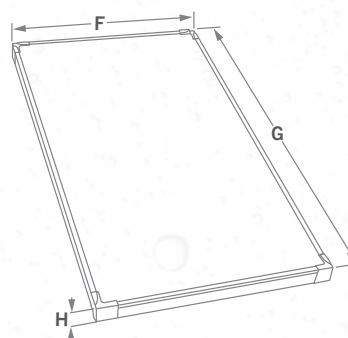

**PRODUCT SPECIFICATION - RHEEM PREMIER® LOLINE SOLAR HOT WATER HEATER<sup>19</sup>**

MODEL	GAS BOOSTED		ELECTRIC BOOSTED	
MODEL	596270 / 2SP-G	596270 / 3SP-G	591270 / 2SP	591270 / 3 SP
	596270 / 2CS 07-G	596270 / 3CS 07-G	591270 / 2CS 07	591270 / 3CS 07
Storage Capacity	Litres	270	270	270
Solar Collectors		2	2	3
Booster Type		Gas – Integrated	Gas – Integrated	Electric
Boost Capacity	Litres	26L/min	26L/min	125
People Per Household		2-5	2-5	1-3
Dimensions & Specifications				
Height (A)	mm	1787	1787	1775
Width (B)	mm	650	650	650
Depth (C)	mm	855	855	682
Cold In (D)	mm	775	775	377
Hot Out (E)	mm	775	775	1078
Weight Empty – Tank	kg	157	157	146
Weight Full – Tank	kg	427	427	416
Weight Empty – Solar Collectors	kg	100	150	150
Weight Full – Solar Collectors	kg	108	162	162

**PRODUCT SPECIFICATION - RHEEM LOLINE SOLAR HOT WATER HEATER<sup>19</sup>**

MODEL	GAS BOOSTED			ELECTRIC BOOSTED		
MODEL	511271 / 2NPT-G	511325 / 2NPT-G	511410 / 2NPT-G	511271 / 2NPT	511325 / 2NPT	511410 / 2NPT
	511271 / 3NPT-G	511325 / 3NPT-G	511410 / 3NPT-G	511271 / 3NPT	511325 / 3NPT	511410 / 3NPT
	511271 / 2LCS-G*	511325 / 2LCS-G*	511410 / 2LCS-G	511271 / 2LCS*	511325 / 2LCS*	511410 / 2LCS
			511410 / 3LCS-G*			511410 / 3LCS*
Storage Capacity	Litres	270	325	410	270	325
Solar Collectors		2 or 3 x NPT200 or 2 or 3 x LCS				
Booster Type		Gas – Remote	Gas – Remote	Gas – Remote	Electric	Electric
Boost Capacity	Litres	26L/min	26L/min	26L/min	140	170
People Per Household		2-5	2-6	3-7	1-3	2-4
Dimensions & Specifications						
Height (A)	mm	1395	1640	1840	1395	1640
Width (B)	mm	640	640	690	640	640
Depth (C)	mm	680	680	730	680	680
Cold In (D)	mm	73	73	81	73	73
Hot Out (E)	mm	1117	1357	1519	1117	1357
Weight Empty – Tank	kg	82	92	115	82	92
Weight Full – Tank	kg	352	418	531	352	418
Weight Full – 2 x Solar Collectors	kg	82	82	82	82	82
Weight Full – 3 x Solar Collectors	kg	123	123	123	123	123

All technical data is subject to change \*LCS Collectors are only available for installation in zones 3 & 4.

**RHEEM PREMIER® LOLINE SOLAR HOT WATER HEATER**

**596 SERIES**

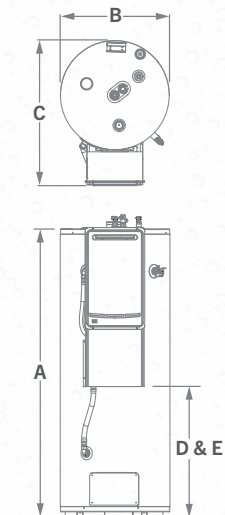

**591 SERIES**

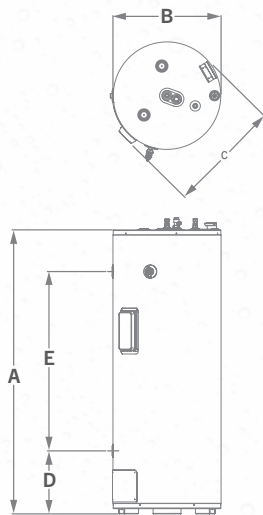

**RHEEM LOLINE SOLAR HOT WATER HEATER**

**511271/511325 & 511410**

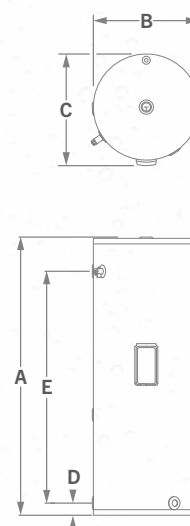

# RHEEM HEAT PUMP PRODUCT DATA

PRODUCT SPECIFICATION - HDc-270 AND MPI-325 HEAT PUMPS		
MODEL	HDc-270	MPI-325
Product Code	551270	551325
Number of People (Moderate Climate)	2-5	2-5
<b>Dimensions</b>		
Height Tank: A (mm)	1825	1631
Width B (mm)	690	888
Depth C (mm)	720	638
Height Module: D (mm)	N/A	1018
<b>Weight &amp; Capacities</b>		
Heat Pump module (kg)	-	42
Tank - empty (kg)	135	88
Capacity (L)	270	325
Rated Heat Pump power input (Watts)	985	800
Refrigerant	R134a	R134a
Element Size (kW)	2.4	3.6
Boost Capacity (L)	195	180
<b>Water Connections &amp; Settings</b>		
Inlet (Rp)	Rp 3/4	Rp 3/4
Outlet (Rp)	Rp 3/4	Rp 3/4
Tank Relief Valve Setting (kPa)	1000	1000
ECV Setting (kPa)	850	850
<b>Maximum Mains Pressure</b>		
With ECV (kPa)	680	680
Without ECV (kPa)	800	800
Min. Water supply pressure (kPa)	-	200

All technical data is subject to change

## HDc-270

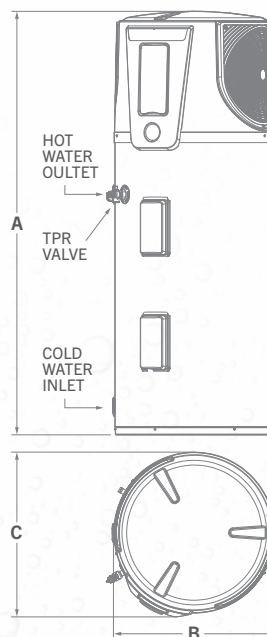

## MPI-325

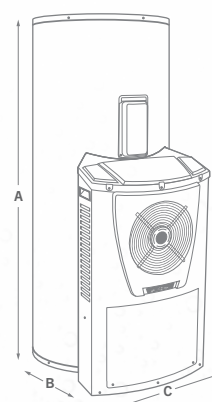

## WARRANTY AND CONDITIONS

- Warranty: 7 year cylinder warranty, 3 year labour warranty on the cylinder, 1 year parts and labour warranty on all other components for domestic (non-commercial) installations. Conditions apply, for full details and conditions which apply visit [www.rheem.com.au/warranty](http://www.rheem.com.au/warranty)
- Warranty: 12 year cylinder warranty, 1 year labour warranty on the cylinder, 1 year parts and labour warranty on all other components for domestic (non-commercial) installations. Conditions apply, for full details and conditions which apply visit [www.rheem.com.au/warranty](http://www.rheem.com.au/warranty)
- Warranty: 12 year cylinder warranty, 3 year labour warranty on the cylinder, 1 year parts and labour warranty on all other components for domestic (non-commercial) installations. Conditions apply, for full details and conditions which apply visit [www.rheem.com.au/warranty](http://www.rheem.com.au/warranty)
- MEPS: Minimum Energy Performance Standards are a regulated requirement that electric water heaters sold in Australia must meet. Performance varies by model. Refer to the Specification table for individual model performance.
- Up to 42% lighter than comparable Rheem vitreous enamel water heater models of the same capacity.
- Left hand outlet factory pre-set to supply hot water to a maximum of 50°C in accordance with AS3498.
- Based on 45°C temperature rise
- Warranty: 10 year cylinder warranty, 1 year labour on cylinder, 1 year parts and labour warranty on all other components for domestic (non-commercial) installations. Conditions apply, for full details and conditions which apply visit [www.rheem.com.au/warranty](http://www.rheem.com.au/warranty)
- Warranty: 10 year cylinder, 3 years labour on cylinder, 1 year parts and labour warranty on all other components for domestic (non-commercial) installations. Conditions apply, for full details and conditions which apply visit [www.rheem.com.au/warranty](http://www.rheem.com.au/warranty)
- Some applications require a tempering valve in accordance with AS/NZS 3500:4
- Based on the most common temperature 43°C shower through a 9 litre/minute showerhead mixing with cold water at 10°C. Rheem 4 star 347 Series with thermostat set at 73°C delivers 15-20% more continual shower time than the Rheem 3 Star with thermostat set at 65°C.
- First hour capacity is the storage capacity plus nominal first hour recovery rate at 45°C temperature rise using Natural Gas, based on a cold water temperature of 15°C. Guide only, subject to individual hot water consumption patterns.
- Warranty: 12 year cylinder warranty, 3 years labour on cylinder, 1 year parts and labour warranty on all other components for domestic (non-commercial) installations. Conditions apply, for full details and conditions which apply visit [www.rheem.com.au/warranty](http://www.rheem.com.au/warranty)
- At 25°C temperature rise. Guide only, subject to ambient water temperature and pressure, correct pipe sizing and appliance flow rates.
- 50°C factory pre-set models supply hot water at a maximum 50°C at all outlets in accordance with AS3498. Some applications may require tempering, refer to AS 3500:4. 60°C models must have a tempering valve installed in accordance with AS 3500:4
- Warranty: 10 years parts and 3 years labour on Heat Exchanger, 3 years parts & labour on other components, when installed in a domestic dwelling. Conditions apply, for full details and conditions which apply visit [www.rheem.com.au/warranty](http://www.rheem.com.au/warranty)
- A tempering valve must be installed as per AS/NZS3500:4.
- Energy and Greenhouse gas emissions savings based on Australian Government Approved TRNSYS simulation modelling of a Rheem Loline Solar Hot Water heater with 2xNPT200 collectors, a Rheem Hiline with 2xNPT200 collectors and a Rheem Premier Hiline with 2xSPA2000 collectors and using a medium load in Zone 3, and apply when replacing an electric water heater. Any savings will vary depending upon type of Rheem Solar system installed, location of the installation, orientation and inclination of the solar collectors, type of water heater being replaced, hot water consumption and fuel tariff. Maximum financial savings off your hot water bill are achievable when replacing an electric water heater on continuous tariff.
- Warranty: Rheem Premier® Loline/Loline/Hiline/Premier Hiline® (52C Model) 5 year supply on cylinder and solar collectors, 3 year labour on cylinder, 1 year labour on collectors, 1 year parts and labour. Applies to a single-family domestic dwelling installation only. Conditions apply, for full details and conditions which apply visit [www.rheem.com.au/warranty](http://www.rheem.com.au/warranty)
- Government incentives may apply if the installation is eligible. Small-scale Technology Certificates (STCs) provide a financial incentive to encourage the installation of Solar and Heat Pump water heaters provided under a Federal Government legislated scheme. Visit [www.rheem.com.au/rebates](http://www.rheem.com.au/rebates) for information on Government Incentives (STC's).
- Energy savings of up to 68% are based on Australian Government approved TRNSYS simulation modelling using a medium load in Zone 3 and apply when replacing an electric water heater of similar size with a Rheem 551270 Heat Pump water heater.
- A COP of 4.5 was measured under test conditions with an ambient air temperature of 19°C/15°C (Dry Bulb/Wet Bulb) and heating of the water from 15°C to 60°C during water heater operation.
- The specified -5°C to 43°C temperature range is the operational range of the 551270 Heat Pump. The electric element activates when the ambient air temperature is outside this range and heating of the water is required.
- 551270 Warranty limits regarding water chemistry. Harsh water regions – the Rheem warranty may not apply if the water heater is connected to a water supply which has a Total Dissolved Solids content >2500mg/L; is scaling with a Saturation Index >+0.8, or; is corrosive with a Saturation Index <-1.0.
- Warranty: 7 years supply on cylinder, 3 years labour on cylinder, 3 years on sealed system including labour, 1 year supply and labour on all other parts. Applies to single family domestic dwelling only. Conditions apply, for full details and conditions which apply visit [www.rheem.com.au/warranty](http://www.rheem.com.au/warranty)
- The impact on an electricity account will depend on the tariff arrangement of the water heater being replaced and where you live. These Heat Pump water heaters (model / climate dependent) are recommended to either 24 hour continuous tariff or extended off-peak (min 16 hours/day). If replacing an electric water heater greater than 250 Litres, heat pump connection to 24 hour continuous tariff is recommended. Before purchase consult your energy provider for more information on cost comparisons.
- Warranty: 5 year supply on cylinder, 3 year labour on cylinder, 2 year supply on sealed system including labour, 1 year supply on all other parts including labour. Applies to a single family domestic dwelling installation only. Conditions apply, for full details and conditions which apply visit [www.rheem.com.au/warranty](http://www.rheem.com.au/warranty)
- Warranty: Rheem Premier® Hiline (52H Models) 7 year supply on cylinder, 5 year supply on solar collectors, 1 year labour on cylinder, 1 year labour on collectors, 1 year parts including labour. Applies to a single-family domestic dwelling installation only. Conditions apply, for full details and conditions which apply visit [www.rheem.com.au/warranty](http://www.rheem.com.au/warranty)

## GLOSSARY OF TERMS

**Recovery rate** – the volume of water a heater can reheat in one hour. Measured as the volume of completely cold water (should the water heater be run completely out) that can be heated to 45°C over the cold water temperature.

**First Hour Capacity** – a measure of water heater capacity that combines both the stored hot water volume & the hourly recovery rate (eg: if a water heater has storage capacity of 130L and a recovery rate of 200L/hour, its First Hour Capacity is 330L).