

Owner's Guide and Installation Instructions



Solar Loline Water Heater



WARNING: Plumber – Be Aware

Use copper pipe ONLY. Plastic pipe MUST NOT be used.

It is a requirement of a solar water heater installation that all pipe work be in copper and not plastic, due to the effects of high water temperatures and pressures.

*This water heater must be installed and serviced by a qualified person.
Please leave this guide with the householder.*



WARNING: Plumber – Be Aware

- The solar hot and solar cold pipes between the solar storage tank and the solar collectors **MUST BE** of copper. All compression fittings must use brass or copper olives.
- The full length of the solar hot and solar cold pipes **MUST BE** insulated.

The insulation must:

- be of a closed cell type or equivalent, suitable for a solar water heating application and capable of withstanding the temperature of the water generated by the solar collectors under stagnation conditions

The specification of the chosen insulation material should be checked with the insulation manufacturer prior to installation as different materials may vary in temperature tolerance.

- be at least 13 mm thick
- be weatherproof and UV resistant if exposed
- extend through any penetrations in the eaves, ceiling and roof
- cover valves and fittings in the solar pipe work
- be fitted up to and cover the connections on both the solar storage tank and the solar collectors.

Note: Failure to observe these requirements also increases the risk of freeze damage.

Uninsulated pipe work, including concealed in cavities and roof spaces or where it may be in contact with a metal roof, may lead to freeze damage. There is NO WARRANTY for freeze damage if the solar hot and solar cold pipes are not insulated in accordance with the installation instructions.

The insulation is essential to assist in providing freeze protection, will offer protection to a metal roof against corrosion due to water running off the copper pipes, assist in avoiding accidental contact with the solar pipe work as very high temperature water can flow from the solar collectors to the solar storage tank, and also reduce pipe heat losses.

- The insulated copper pipe work:
 - should be fixed at suitable locations to prevent or reduce the possibility of noise from water hammer and vibration from occurring
 - is not to be placed or installed in contact with plastic pipe work.

Likewise, plastic pipe work is not to be placed or installed in contact with the insulated copper pipe work after the collector circuit is installed.

- Plastic pipe **MUST NOT** be used, as it will not withstand the temperature and pressure of the water generated by the solar collectors under stagnation conditions. Extremely high water temperatures of up to 150°C for non-selective surface collectors and greater than 200°C for selective surface collectors and high water pressures exceeding 1000 kPa can be generated under these conditions. Plastic pipe cannot withstand these temperatures and pressures and **MUST NOT** be used. Failure of plastic pipe can lead to the release of high temperature water and cause severe water damage and flooding.

Plumber: It is important to refer to and read in full the complete “Warning: Plumber – Be Aware” statement commencing on page 44.

An electronic copy of these Owner’s Guide and Installation Instructions can be downloaded from rheem.com.au.

PATENTS

This water heater may be protected by one or more patents or registered designs in the name of Rheem Australia Pty Ltd.

TRADE MARKS

© Registered trademark of Rheem Australia Pty Ltd.
™ Trademark of Rheem Australia Pty Ltd.

Note: Every care has been taken to ensure accuracy in preparation of this publication. No liability can be accepted for any consequences, which may arise as a result of its application.

CONTENTS

HOUSEHOLDER

This booklet contains important information about your new water heater, including terms of the Rheem warranty.

We recommend you read pages 7 to 26, and the terms of the Rheem warranty on pages 4 to 6.

The other pages are intended for the installer but may be of interest.

Warranty	4
Safety, Warnings, Installation Notes	7
About Your Water Heater	10
Maintenance Requirements.....	18
Water Supplies.....	20
Save A Service Call	23
Installation – System.....	27
Installation – Solar Storage Tank.....	30
Installation – Solar Control Unit.....	37
Installation – Solar Collectors.....	40
Connections – Plumbing	46
Connections – Electrical.....	49
Commissioning.....	52
Draining The Solar Collectors.....	56
Draining The Solar Storage Tank.....	56
Purging And Flushing The Solar Collectors.....	57
Installation Report	61

RHEEM AUSTRALIA PTY LTD, A.B.N. 21 098 823 511, www.rheem.com.au
For Service Telephone 131 031 AUSTRALIA

RHEEM SOLAR LOLINE WATER HEATER WARRANTY – AUSTRALIA ONLY –

SOLAR LOLINE WATER HEATER MODELS 511271, 511325, 511410

1. THE RHEEM WARRANTY – GENERAL

- 1.1 This warranty is given by Rheem Australia Pty Limited ABN 21 098 823 511 of 1 Alan Street, Rydalmere New South Wales.
- 1.2 Rheem offer a trained and qualified national service network who will repair or replace components at the address of the water heater subject to the terms of the Rheem warranty. Rheem Service, in addition can provide preventative maintenance and advice on the operation of your water heater. The Rheem Service contact number is 131031, with Contact Centre personnel available 24 hours, 7 days a week to take your call and if necessary to arrange a service call for during normal working hours Monday to Friday (hours subject to change).
- 1.3 For details about this warranty, you can contact us on 131031 or by email at warrantyenquiry@rheem.com.au (not for service bookings).
- 1.4 The terms of this warranty and what is covered by it are set out in sections 2 and 3 and apply to water heaters manufactured from the 1st November 2018.
- 1.5 If a subsequent version of this warranty is published, the terms of that warranty and what is covered by it will apply to water heaters manufactured after the date specified in the subsequent version.

2. TERMS OF THE RHEEM WARRANTY AND EXCLUSIONS TO IT

- 2.1 The decision of whether to repair or replace a faulty component is at Rheem's sole discretion.
 - 2.2 If you require a call out and we find that the fault is not covered by the Rheem warranty, you are responsible for our standard call out charge. If you wish to have the relevant component repaired or replaced by Rheem, that service will be at your cost.
 - 2.3 Where a failed component or cylinder is replaced under this warranty, the balance of the original warranty period will remain effective. The replacement does not carry a new Rheem warranty.
 - 2.4 Where the water heater is installed outside the boundaries of a metropolitan area as defined by Rheem or further than 25 km from either a regional Rheem branch office or an Accredited Rheem Service Agent's office, the cost of transport, insurance and travelling between the nearest branch office or Rheem Accredited Service Agent's office and the installed site shall be the owner's responsibility.
 - 2.5 Where the water heater is installed in a position that does not allow safe or ready access, the cost of that access, including the cost of additional materials handling and/or safety equipment, shall be the owner's responsibility. In other words, the cost of dismantling or removing cupboards, doors or walls and the cost of any special equipment to bring the water heater to floor or ground level or to a serviceable position is not covered by this warranty.
 - 2.6 This warranty only applies to the original and genuine Rheem water heater in its original installed location and any genuine Rheem replacement parts.
 - 2.7 The Rheem warranty does not cover faults that are a result of:
 - a) Accidental damage to the water heater or any component (for example: (i) Acts of God such as floods, storms, fires, lightning strikes and the like; and (ii) third party acts or omissions).
 - b) Misuse or abnormal use of the water heater.
 - c) Installation not in accordance with the Owner's Guide and Installation Instructions or with relevant statutory and local requirements in the State or Territory in which the water heater is installed.
 - d) Connection at any time to a water supply that does not comply with the water supply guidelines as outlined in the Owner's Guide and Installation Instructions.
 - e) Repairs, attempts to repair or modifications to the water heater by a person other than Rheem Service or a Rheem Accredited Service Agent.
-

RHEEM SOLAR LOLINE WATER HEATER WARRANTY – AUSTRALIA ONLY –

SOLAR LOLINE WATER HEATER MODELS 511271, 511325, 511410

- f) Faulty plumbing or faulty power supply.
 - g) Failure to maintain the water heater in accordance with the Owner's Guide and Installation Instructions.
 - h) Transport damage.
 - i) Fair wear and tear from adverse conditions (for example, corrosion).
 - j) Cosmetic defects.
 - k) Breakage of collector glass for any reason including hail damage (we suggest that the collector glass be covered by your home insurance policy).
 - l) Ice formation in the waterways of a water heater system incorporating a freeze protection system where the electricity supply has been switched off or has failed or where it is installed at an altitude more than 400 metres above sea level.
- 2.8 Rheem may reject a claim under this warranty in its sole discretion if a third party solar diverter is connected to the water heater.
- 2.9 Subject to any statutory provisions to the contrary, this warranty excludes any and all claims for damage to furniture, carpet, walls, foundations or any other consequential loss either directly or indirectly due to leakage from the water heater, or due to leakage from fittings and/ or pipe work of metal, plastic or other materials caused by water temperature, workmanship or other modes of failure.
- 2.10 If the water heater is not sized to supply the hot water demand in accordance with the guidelines in the Rheem water heater literature, any resultant fault will not be covered by the Rheem warranty.

3. WHAT IS COVERED BY THE RHEEM WARRANTY FOR THE WATER HEATERS DETAILED IN THIS DOCUMENT

- 3.1 Rheem will repair or replace a faulty component of your water heater if it fails to operate in accordance with its specifications as follows:

What components are covered	The period from the date of installation in which the fault must appear in order to be covered	What coverage you receive
Loline 511 Series Vitreous Enamel models		
All components	Year 1	Repair and/or replacement of the faulty component, free of charge, including labour.
The cylinder (if the water heater is installed in a single-family domestic dwelling)	Years 2 & 3	Repair and / or replacement of the cylinder, free of charge, including labour.
	Years 4 & 5	Replacement cylinder, free of charge. Installation and repair labour costs are the responsibility of the owner.
The cylinder (if the water heater is <u>not</u> installed in a single-family domestic dwelling)	Years 2 & 3	Replacement cylinder, free of charge. Installation and repair labour costs are the responsibility of the owner.
The solar collector (all installations)	Years 2 to 5	Replacement solar collector, free of charge. Installation and repair labour costs are the responsibility of the owner.

RHEEM SOLAR LOLINE WATER HEATER WARRANTY – AUSTRALIA ONLY –

SOLAR LOLINE WATER HEATER MODELS 511271, 511325, 511410

4. ENTITLEMENT TO MAKE A CLAIM UNDER THIS WARRANTY

- 4.1 To be entitled to make a claim under this warranty you need to:
- a) Be the owner of the water heater or have consent of the owner to act on their behalf.
 - b) Contact Rheem Service without undue delay after detection of the defect and, in any event, within the applicable warranty period.
- 4.2 You are not entitled to make a claim under this warranty if your water heater:
- a) Does not have its original serial numbers or rating labels.
 - b) Is not installed in Australia.

5. HOW TO MAKE A CLAIM UNDER THIS WARRANTY

- 5.1 If you wish to make a claim under this warranty, you need to:
- a) Contact Rheem on 131031 and provide owner's details, address of the water heater, a contact number and date of installation of the water heater or if that's unavailable, the date of manufacture and serial number (from the rating label on the water heater).
 - b) Rheem will arrange for the water heater to be tested and assessed on-site.
 - c) If Rheem determines that you have a valid warranty claim, Rheem will repair or replace the water heater in accordance with this warranty.
- 5.2 Any expenses incurred in the making of a claim under this warranty will be borne by you.

6. THE AUSTRALIAN CONSUMER LAW

- 6.1 Our goods come with guarantees that cannot be excluded under the Australian Consumer Law. You are entitled to a replacement or refund for a major failure and for compensation for any other reasonably foreseeable loss or damage. You are also entitled to have the goods repaired or replaced if the goods fail to be of acceptable quality and the failure does not amount to a major failure.
- 6.2 The Rheem warranty (set out above) is in addition to any rights and remedies that you may have under the Australian Consumer Law.

SAFETY, WARNINGS, INSTALLATION NOTES

It is important you read the following safety and warnings information.

SAFETY AND WARNINGS

- This water heater is only intended to be operated by persons who have the experience or the knowledge and the capabilities to do so.
- This water heater is not intended to be operated by persons with reduced physical, sensory or mental capabilities i.e. the infirm, or by children. Children should be supervised to ensure they do not interfere with the water heater.
- If the power supply cord or plug to the solar control unit or the electrical conduit to the solar storage tank is damaged, it must be replaced by a qualified person in order to avoid a hazard. The power supply cord and plug must be replaced with a genuine replacement part available from Rheem. Phone Rheem Service or their nearest Accredited Service Agent to arrange for an inspection.
- The power lead from the solar controller must be plugged into a weatherproof electrical outlet if installed outdoors. Take care not to touch the power plug with wet hands.
- This water heater uses 220 V - 240 V a.c. electrical power for operation of the control systems and the electrically operated components. The removal of the front cover or solar control unit cover will expose 220 V - 240 V a.c. wiring. They must only be removed by a qualified person.
- This water heater is supplied with a thermostat, over-temperature cut-out, temperature sensors and a combination temperature pressure relief valve. These devices must not be tampered with or removed. The water heater must not be operated unless each of these devices is fitted and is in working order.

The Rheem warranty may not cover faults if relief valves or other safety devices are tampered with or if the installation is not in accordance with these instructions.

- **DANGER:** The operation of the over-temperature cut-out on a thermostat indicates a possibly dangerous situation. If the over-temperature cut-out operates, it must not be reset and the water heater must be serviced by a qualified person.
- Do not touch any exposed pipe work or fittings connecting the solar storage tank and the solar collectors, as this may result in a burn injury. Very high temperature hot water and in some circumstances high temperature steam can be generated by the solar collectors under certain conditions and this flows through the pipe work from the solar collectors to the solar storage tank.

Note: Any exposed pipe work or fittings in the collector circuit should be attended to and covered with insulation. Phone Rheem Service or their nearest Accredited Service Agent to arrange for an inspection.

- The circulator will operate whilst suitable solar conditions are available until water in the solar storage tank is heated to 70°C to 75°C during normal operation, and up to 75°C to 80°C could be reached during over-temperature operation. During times of low solar energy gain or if boosting of the water temperature is required, an electric heating unit will heat the water temperature to 60°C or up to 70°C depending upon the thermostat setting.

Refer to “Solar Operation” on page 10 and to “How Hot Should The Water Be?” on page 12.

- For continued safety of this water heater it must be installed, operated and maintained in accordance with the Owner’s Guide and Installation Instructions.
- Servicing of a water heater must only be carried out by qualified personnel. Phone Rheem Service or their nearest Accredited Service Agent.
- The lever on the temperature pressure relief valve and expansion control valve (if fitted) requires to be operated every six (6) months to clear any deposits and to ensure the valve and its drain line are not blocked.

Refer to “Relief Valves” on page 8 and “Minor Maintenance Every Six Months” on page 18.

- Only a person qualified to install or service a water heater can drain the water heater, if this is required.

- Do not modify this water heater.
- In areas where there is a risk of freezing conditions, power must be available to the solar control unit at all times. The electrical supply to the solar control unit should not be switched off otherwise the freeze protection system will be rendered inoperable and damage could result. If it is necessary to switch the power off to the solar control unit and there is a risk of freezing, then it is necessary to have a plumber drain the solar collectors and solar hot and solar cold pipes. Refer to “Freeze Protection” on page 16.

RELIEF VALVES

Temperature Pressure Relief Valve

This water heater incorporates a temperature pressure relief valve located near the top of the solar storage tank. This valve is essential for the water heater’s safe operation.

It is possible for the valve to discharge a quantity of water through the drain line during each heating period. This quantity should be equal to approximately 1/50 of the hot water used, as water expands by this volume when heated.

Expansion Control Valve

In many areas, including South Australia, Western Australia and scaling water areas, it is mandatory an expansion control valve is fitted to the cold water line to the water heater.

The expansion control valve will discharge the quantity of water from its drain line during the heating period instead of the temperature pressure relief valve as it has a lower pressure rating.

Valve Operation

Continuous leakage of water from either valve and its drain line may indicate a problem with the water heater. Refer to “Temperature Pressure Relief Valve or Expansion Control Valve Running” on page 24.

⚠ Warning: Never block the outlet of either valve or their drain lines for any reason. A relief valve drain must be left open to atmosphere, and be installed in a continuously downward direction.

In locations where water pipes are prone to freezing, the relief valve drain line must be insulated and not exceed 300 mm in length before discharging into a tundish through an air gap.

Operate the easing lever on the temperature pressure relief valve and expansion control valve once every six (6) months to clear any deposits and ensure the valve and its drain line are not blocked. **It is very important the lever is raised and lowered gently.** Refer to “Minor Maintenance Every Six Months” on page 18.

⚠ Warning: Water discharged from the temperature pressure relief valve drain line will be hot. Exercise care to avoid any splashing of water by standing clear of the drain line’s point of discharge when operating either valve’s easing lever.

⚠ DANGER: Failure to operate the easing lever on the relief valve once every six (6) months may result in the solar storage tank cylinder failing, or under certain circumstances, exploding.

If water does not flow freely from the drain line when the lever is lifted, then the water heater must be checked. Phone Rheem Service or their nearest Accredited Service Agent to arrange for an inspection.

The temperature pressure relief valve should be replaced at intervals not exceeding five (5) years and the expansion control valve should be checked for performance or replaced at intervals not exceeding five (5) years. The checking of the valves performance or replacement should occur more frequently in areas where there is a high incidence of water deposits. Refer to “Water Supplies” on page 20.

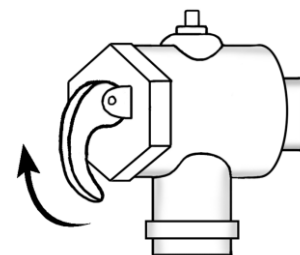
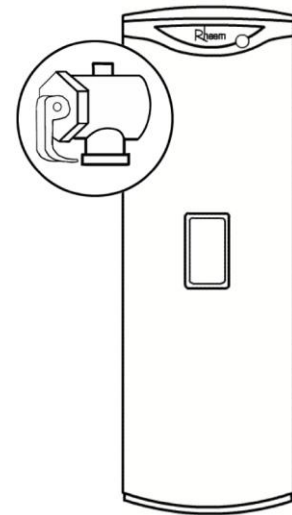

lift until water flows from the drain line – lower gently

outlet / drain line

INSTALLATION NOTES

This water heater must be installed:

- by a qualified person,
- in accordance with the installation instructions,
- in compliance with the Plumbing Code of Australia (PCA) and Plumbing Standard AS/NZS 3500.4,
 - The solar storage tank is designed for either indoor or outdoor installation.
 - This water heater is intended to be permanently connected to the water mains and not connected by a hose-set. A braided flexible hose or semi-flexible connector may be used for connection to the water heater, where permitted by AS/NZS 3500.4.
- in compliance with the Australian / New Zealand Wiring Rules AS/NZS 3000,
 - Isolation switches must be installed in the electrical circuit to the water heater in accordance with the Wiring Rules, so the water heater can be switched off.
 - The power supply wires are to be directly connected to the terminal block and earth tab connection, with no excess wire loops inside the front cover. The temperature rating of the power supply wires insulation must suit this application, or the wiring protected by insulating sleeving with an appropriate temperature rating if it can make contact with the internal storage cylinder. The temperature of the internal storage cylinder can reach 75°C under normal operation.
- in compliance with all local codes and regulatory authority requirements.

Installation and commissioning requirements and details for the installing plumber and licensed electrical worker are contained on [pages 27 to 55](#).

Mains pressure water supply

The water heater is designed to operate at mains pressure by connecting directly to the mains water supply.

The water heater is supplied with a temperature pressure relief valve with a pressure rating of 1000 kPa. If an expansion control valve has been installed on the cold water line to the water heater, this should have a pressure rating of 850 kPa.

The maximum mains water supply pressure for the water heater is 800 kPa if an expansion control valve is not installed, or 680 kPa if an expansion control valve is installed. If the mains supply pressure in your area exceeds these values, a pressure limiting valve must be installed.

A minimum water supply pressure of 200 kPa is required to enable the solar circulator and collector circuit system to operate effectively.

The supply pressure should be greater than 350 kPa for true mains pressure operation to be achieved.

ABOUT YOUR WATER HEATER

WATER HEATER APPLICATION

This water heater is designed for use in a single family domestic dwelling for the purpose of heating potable water. Its use in an application other than this may shorten its life.

MODEL TYPE

The Rheem Loline® open circuit solar water heater system is designed for the solar collectors to be roof mounted and the vitreous enamel lined solar storage tank to be remotely installed at ground or floor level. The solar storage tank is suitable for either outdoor or indoor installation and can be installed with Rheem NPT 200, LCS or CSA2007 solar collectors.

This water heater is designed to be installed as an electric boosted solar water heater with its booster heating unit connected to a power supply. The booster heating unit is housed under the front cover located at the midpoint of the tank.

The system has a level of freeze protection designed to guard the system against damage from freeze conditions (refer to “Freeze Protection” on page 16). The system must be installed with the full length of the solar hot and solar cold pipes insulated and power must be available at the solar control unit to offer protection against freeze damage (refer to “Warning: Plumber – Be Aware” on page 44). Freeze conditions occur below 6°C.

The system is not recommended for installation above 400 metres altitude. A system has NO WARRANTY for freeze damage when installed above 400 metres altitude or if the solar hot and solar cold pipes are not insulated in accordance with the installation instructions or if power is not available at the solar control unit (refer to “Terms of the Rheem Warranty” on page 4).

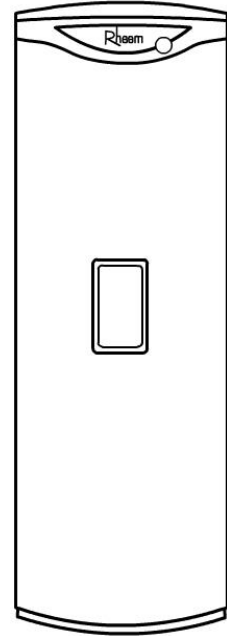

Note: The Rheem warranty against freeze damage applies only to systems installed in Australia.

Although designed to be installed as an electric boosted solar water heater, the water heater may also be installed with an in-series continuous flow or storage booster.

If this water heater is installed with an in-series booster, then the electric booster heating unit will not be connected to a power supply and the references to the electric booster heating unit, thermostat and boosting controls in this Guide will not be applicable to the installation. For information relating to the function and operation of the in-series booster, refer to the Owners Guide and Installation Instructions supplied with the booster water heater.

Automatic safety controls are fitted to the water heater to provide safe and efficient operation.

SOLAR OPERATION

The operation of the circulator is controlled by the combination of:

- the hot sensor located at the outlet of the solar collectors.
The hot sensor measures the water temperature at the outlet of the solar collectors.
- the cold sensor located at the solar cold outlet at the base of the solar storage tank
The cold sensor measures the water temperature at the bottom of the solar storage tank.
- the differential controller located in the solar control unit.

Normal operation

As the sun heats the water in the solar collectors, the increase in temperature activates the circulator. The circulator switches on whenever the water in the solar collectors is hotter than the water in the solar storage tank. The circulator moves the cooler water from the solar storage tank to the solar collectors via the solar cold pipe, to be heated by the sun's energy, and the hotter water from the solar collectors is circulated through the solar hot pipe to the solar storage tank.

This process continues whilst solar energy is available and the water in the solar storage tank requires heating. The circulator will deactivate when the water temperature in the solar storage tank is around 70°C to 75°C. The water heater will then enter Over-temperature operation.

During normal operation if the amount of solar energy available reduces, such as when the sky becomes very cloudy or the sun becomes lower in the sky in the late afternoon, and the water no longer gains useable heat from the solar collectors, the circulator will deactivate. The water heater will then enter standby mode.

Over-temperature operation

The purpose of the Over-temperature operation is to reduce the amount of overheating or 'stagnation' of water in the solar collectors. When the water in the solar storage tank has reached 70°C to 75°C and the circulator has deactivated, the solar collectors will continue to gain heat while solar energy is still available.

If the water in the solar collectors stagnates and its temperature becomes very high, the circulator will activate for a short period to transfer this extra energy to the solar storage tank. The circulator will deactivate when the water temperature in the solar collectors decreases. This process will either repeat for a maximum of eight cycles or until the water temperature in the solar storage tank reaches around 75°C to 80°C or the hot sensor does not sense another increase in water temperature to a stagnation level after a cycle is completed, i.e. the solar energy available reduces.

Night Time Cooling operation

The purpose of Night Time Cooling operation is to rid the solar storage tank of excess solar energy gained by Over-temperature operation during that day. The desired water temperature in the solar storage tank is to be between 60°C and 70°C.

If the solar control unit has entered Over-temperature operation during the day, then after the water temperature in the solar collectors reduces later in the day or early evening, the circulator will activate. Water from the solar storage tank will circulate through the solar collectors and excess heat in the water will radiate from the solar collectors reducing the temperature of the water. The water will circulate for a period of time and until the water temperature in the solar storage tank is around 60°C to 70°C. The water heater will then enter standby mode.

Freeze Protection operation

The purpose of Freeze Protection operation is to prevent freezing of water in the solar collectors and solar pipe work in very cold conditions. The water in the solar collectors will cool during periods of no solar gain. In very cold conditions, such as overnight and very early in the morning before sunrise, the water temperature can approach freezing point.

If the hot sensor measures that the water temperature in the solar collectors is approaching freezing, the circulator will activate. Water from the solar storage tank, containing more energy than the water in the solar collectors, will circulate through the solar collectors keeping the water temperature above freezing point. The circulator will remain on for some minutes and until the hot sensor measures a water temperature at a safe level above freezing. When both of these conditions are met, the circulator will deactivate. The water heater will then enter standby mode.

This process will repeat whenever the hot sensor measures that the water temperature in the solar collectors is approaching freezing.

Refer to "[Freeze Protection](#)" on page 16 and "[Warning: Plumber – Be Aware](#)" on page 44.

Standby mode

The water heater will be in Standby mode whenever conditions are not favourable for solar heating in Normal operation, and Over-temperature operation and Night Time Cooling are not required or have been completed, and conditions are not cold enough for or in-between Freeze Protection operation.

Solar Monitor LED operation

The LEDs on the Solar Monitor, located on the side of the solar control unit, operate to show the operational mode of the water heater. Refer also to “Solar Monitor” on page 15.

Mode	Green LED		Red LED
	power on* > 48 hours	power on* < 48 hours	
Normal operation	rapid pulse	3 flashes	off **
Over-temperature operation	rapid pulse	3 flashes	off, or solid then off
Night Time Cooling operation	rapid pulse	3 flashes	off
Freeze Protection operation	rapid pulse	3 flashes	off
Standby mode	solid	slow pulse	off

Notes

* Power from the GPO to the solar control unit.

** In Normal Operation the red LED may emit a rapid pulse for a short period of time under certain circumstances (refer to “Rapid Pulsing” on page 25).

ELECTRIC BOOSTING

Water stored in the solar storage tank can be heated by an electric booster heating unit. The booster heating unit is for heating the water at times of low solar energy gain, such as during very cloudy or rainy weather, or during the colder months.

The amount of water heated by the raised booster heating unit of the Loline solar storage tank is 220 litres (410 model), 170 litres (325 model) or 140 litres (271 model).

The water heater is most suited for the booster heating unit to be connected to either a continuous, or a time of use, or an extended Off-Peak (overnight and day) electricity supply. A timer can also be used to control the boosting periods and help maximise solar savings. Refer to “Booster Control” on page 14.

The booster heating unit may be connected to an Off-Peak (overnight) electricity supply, however this will only allow the booster to heat the water overnight. If this type of connection is considered, care must be taken to ensure there is sufficient boost capacity to meet the household’s full day and night’s hot water supply during periods of no or low solar gain, particularly in cold weather.

The booster heating unit is controlled by an electric thermostat. The thermostat and its over-temperature energy cut-out are mounted on the solar storage tank behind the front cover. If required, the water is heated automatically to the thermostat setting by the booster heating unit when power is available.

HOW HOT SHOULD THE WATER BE?

The solar control unit will circulate water through the solar collectors until a temperature of 70°C to 75°C is reached during normal operation.

During periods of low solar energy gain, the water temperature can be boosted by the thermostatically controlled electric booster heating unit. Refer to “Booster Control” on page 14.

Rheem recommends the thermostat is set at 60°C to maximise solar contribution.

Note: AS 3498 requires that a water heater provides the means to inhibit the growth of Legionella bacteria in potable water. This water heater can satisfy this AS 3498 requirement provided the electric booster is energised for a sufficient period each day and the electric booster thermostat setting is 60°C or higher.

If this water heater is installed with an in-series continuous flow gas booster, then this requirement of AS 3498 can be satisfied provided the booster is energised, its preset outlet temperature setting is 70°C or higher and a remote temperature controller or an EZiSET kit is not used.

If this water heater is installed with an in-series storage booster, then this requirement of AS 3498 can be satisfied provided the storage booster is energised and its thermostat setting is 60°C or higher.

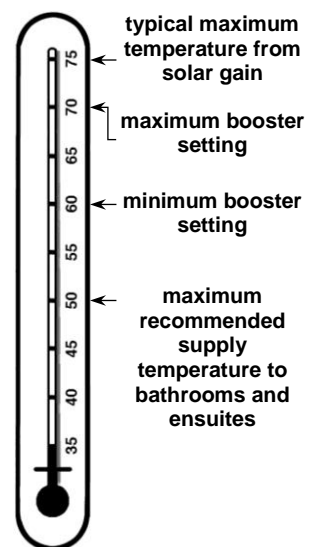

HOTTER WATER INCREASES THE RISK OF SCALD INJURY

This water heater can deliver hot water at temperatures which on occasion could exceed 75°C, sufficiently hot to cause severe scalding. Water at this temperature may have been plumbed to fixtures where water hotter than 50°C is allowed, such as the kitchen and laundry.

Check the water temperature before use, such as when entering a shower or filling a bath or basin, to ensure it is suitable for the application and will not cause scald injury.

We recommend and it may also be required by regulations, that an approved temperature limiting device be fitted into the hot water pipe work to the bathroom and ensuite when this water heater is installed. This will keep the water temperature below 50°C at the bathroom and ensuite. The risk of scald injury will be reduced and still allow hotter water to the kitchen and laundry.

TEMPERATURE ADJUSTMENT

The water heater features a tradesperson adjustable thermostat that automatically controls the electricity supply to the booster heating unit. This requires a licensed electrical worker to make any temperature adjustments. The thermostat is factory set at 60°C. The thermostat has a maximum temperature setting of 70°C and a minimum temperature setting of 60°C.

We advise you to have a licensed electrical worker adjust the thermostat to the lowest setting which meets your needs, especially if there are young children or elderly people in the home. Refer to [“Hotter Water Increases the Risk of Scald Injury”](#) on page 13.

TO TURN OFF THE WATER HEATER

If you plan to be away from home for a few nights, we suggest you leave the water heater switched on.

If it is necessary to turn off the water heater:

- Switch off the electrical supply at the water heater isolating switch on the switchboard and at the isolating switch at the solar storage tank (if installed).
- Switch off the electrical supply to the solar control unit at the power outlet (refer to note below).
- Close the cold water isolation valve at the inlet to the water heater.

Notes

- The freeze protection system will be rendered inoperable if electrical power is not available at the solar control unit. Damage caused by freezing due to no power at the solar control unit is not covered by the Rheem warranty. Refer to [“Terms of the Rheem Warranty”](#) on page 4.
- If there is a risk of freezing, the electrical supply to the solar control unit should not be switched off unless the solar collectors and solar hot and solar cold pipes are drained, otherwise damage could result (refer to [“Freeze Protection”](#) on page 16).

TO TURN ON THE WATER HEATER

- Open the cold water isolation valve fully at the inlet to the water heater.
- If the solar collectors and solar hot and solar cold pipes have been drained, it will be necessary to have a plumber purge the collector circuit of air.

If the electrical supply to the water heater has been switched off:

- Switch on the electrical supply to the solar control unit at the power outlet. The power outlet must be switched on for the solar control unit to operate and solar gain to be achieved.
- Switch on the electrical supply at the water heater isolating switch on the switchboard and at the isolating switch at the solar storage tank (if installed).
- Check and if required reset the timer, if one is installed.

BOOSTER CONTROL

An isolating switch is installed in the electrical meter box for the solar storage tank, and a second isolating switch may be installed adjacent to the solar storage tank. These should be left switched on to allow the booster heating unit to operate if required. The booster heating unit is for heating the water at times of low solar energy gain, such as during very cloudy or rainy weather, or during the colder months.

Leaving the isolating switch(s) switched on will also provide a sufficient period of time each day for the booster heating unit to operate, if required, to satisfy the requirements of AS 3498.

The booster heating unit will only activate if heating is required and power is available from the switchboard. When the water is below the thermostat setting, the booster heating unit will turn on and heat the water. The booster heating unit will automatically turn off when the temperature of the water reaches the thermostat setting.

Timer Control Switch

A suitably rated timer control switch can be installed and will help maximise energy savings with an electrically boosted solar water heater connected to a **continuous, time of use or extended Off-Peak (overnight and day)** electricity supply. Further information for a licenced electrical worker on the recommended methods of wiring the timer are outlined in **“Booster Control”** on page 51.

Programming the Timer

Power must be available to the timer control switch before the booster heating unit can be activated.

The timer control switch should be programmed:

- to suit the hot water consumption pattern of the household,
- with the end of the period to coincide with the commencement of the evening hot water usage,
A second period, such as prior to the morning hot water usage, may be necessary.
- to enable a boosting period of not less than the recommended continuous length of time for boosting,
- for a period when power will be available to the timer.

Note: When daylight saving time applies, you may consider resetting the timer accordingly.

The recommended continuous length of time for boosting is:

Model	Minimum winter cold water temperature		Temperature rise	Booster heating unit size		
				2.4 kW	3.6 kW	4.8 kW
271	Cool / temperate climate	10°C	50°C	3 ½ hours	2 ½ hours	1 ¾ hours
	Temperate / sub-tropical climate	15°C	45°C	3 ¼ hours	2 ¼ hours	1 ¾ hours
	Tropical climate	20°C	40°C	2 ¾ hours	2 hours	1 ½ hours
325	Cool / temperate climate	10°C	50°C	4 ¼ hours	3 hours	2 ¼ hours
	Temperate / sub-tropical climate	15°C	45°C	3 ¾ hours	2 ½ hours	2 hours
	Tropical climate	20°C	40°C	3 ½ hours	2 ¼ hours	1 ¾ hours
410	Cool / temperate climate	10°C	50°C	5 ½ hours	3 ¾ hours	2 ¾ hours
	Temperate / sub-tropical climate	15°C	45°C	5 hours	3 ¼ hours	2 ½ hours
	Tropical climate	20°C	40°C	4 ½ hours	3 hours	2 ¼ hours

Factory fitted booster heating unit size is 3.6 kW

The recommended boosting periods are sufficient to allow the booster heating unit to heat up the boost volume of the solar storage tank to 60°C where the winter cold water temperatures do not fall below those shown. This may be necessary during periods of no or very low solar energy gain through the solar collectors, such as during constant rain or extremely cloudy weather, particularly in winter when the incoming cold water temperature is lower. The period will also provide a sufficient heat up time for the electric booster to operate, if required, to satisfy the requirements of AS 3498.

The booster heating unit will only activate if heating is required and power is available from the timer. When the water is below the thermostat setting, the booster heating unit will turn on and heat the water. The booster heating unit will automatically turn off either when the temperature of the water reaches the thermostat setting or at the end of the timer period, whichever comes first.

SOLAR MONITOR

A solar monitor is located on the side of the solar control unit and houses a green and a red LED.

The green LED, marked “Solar”, indicates the current operational mode of the solar water heater and the red LED, marked “Attention”, may indicate a potential fault mode.

The green LED will emit either a constant glow, a constant pulsing or a series of flashes, with a two (2) second interval between each series.

The red LED will emit either a constant glow, a constant pulsing or a series of flashes with a two (2) second interval between each series. A constant glow or pulsing does not necessarily mean there is a fault with the system. A series of flashes indicates there may be a particular fault condition with the system.

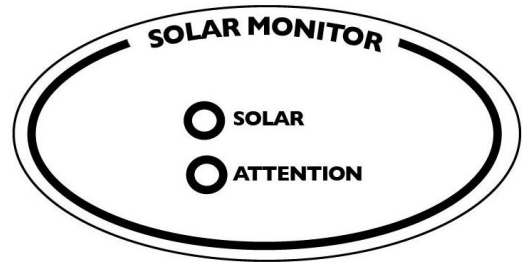

The modes are:

Flashes	Operational Modes
solid green (remains on)	Standby mode
green slow pulse	Standby mode (power on for less than 48 hours)
green rapid pulse	Circulating water through collectors
3 x green	Circulating water through collectors (power on for less than 48 hours)
no green (remains off)	Power outage or call for service

Flashes	Indicator or Fault Modes
solid red (remains on)	Hot sensor temperature greater than 130°C
red rapid pulse	Temperature rise across collector greater than 45°C (circulator at full speed)
3 x red	Hot sensor in collector – short circuit
4 x red	Hot sensor in collector – open circuit
5 x red	Cold sensor –short circuit
6 x red	Cold sensor – open circuit

If the power supply to the solar control unit is on and the green LED is off or the red LED is flashing, this indicates there may be a fault with the water heater. The red LED may emit from three (3) to six (6) flashes in each series of flashes. A constant glow or pulsing of the red LED does not necessarily mean there is a fault with the system.

Notes

- If the system is in standby mode with the green LED emitting either a constant glow or slow pulsing flashes (circulator is off) and the solar storage tank is full of hot water, the red LED may simultaneously emit a constant glow if solar radiation is still being received by the solar collectors. This does not indicate a fault. The red LED will go out when the temperature in the solar collectors decreases.
- During periods of high solar radiation and the circulator activates after having been off (the green LED will emit either a rapid pulse or a series of three flashes), it is possible the red LED may simultaneously emit a rapid pulse for a period of up to ten (10) minutes. This does not indicate a fault.

If the red LED continues to emit a rapid pulse for longer than ten (10) minutes, or emits a series of flashes, then count the number of flashes and phone Rheem Service or their nearest Accredited Service Agent to arrange for an inspection.

FREEZE PROTECTION

The system has a level of freeze protection designed to guard the system against damage from freeze conditions. The system must be installed with the full length of the solar hot and solar cold pipes insulated and power must be available at the solar control unit to offer protection against freeze damage (refer to [“Warning: Plumber – Be Aware”](#) on page 44). Freeze conditions occur below 6°C.

Note: The Rheem warranty against freeze damage applies only to systems installed in Australia.

The anti-freeze control is designed to recirculate a small amount of water from the solar storage tank through the solar pipe work and solar collectors during periods of low temperatures. This is to prevent the water inside the pipe work and collectors from freezing. It is essential the electrical circuit to the solar control unit is continually turned on if there is a risk of freezing. The Rheem warranty does not cover damage caused by freeze conditions when the electrical circuit to the solar control unit is turned off or interrupted.

A system has NO WARRANTY for freeze damage when installed above 400 metres altitude or if the solar hot and solar cold pipes are not insulated in accordance with the installation instructions or if power is not available at the solar control unit (refer to [“Terms of the Rheem Warranty”](#) on page 4).

Notes

- A system is not covered for freeze damage above 400 metres altitude by the Rheem warranty.
- The freeze protection system will be rendered inoperable if electrical power is not available at the solar control unit. Damage caused by freezing due to no power at the solar control unit, is not covered by the Rheem warranty.
- If it is necessary to switch the power off to the solar control unit and there is a risk of freezing, then it is necessary to have a plumber drain the solar collectors and solar hot and solar cold pipes.
- Refer to [“Terms of the Rheem Warranty”](#) on page 4.

PRECAUTIONS

Where damage to property can occur in the event of the solar storage tank leaking, the solar storage tank must be installed in a safe tray. Construction, installation and draining of a safe tray must comply with AS/NZS 3500.4 and all local codes and regulatory authority requirements.

The water heater must be maintained in accordance with the Owner’s Guide and Installation Instructions. Refer to [“Maintenance Requirements”](#) on page 18 and to [“Anode Inspection and Replacement”](#) on page 21.

If this water heater is to be used where an uninterrupted hot water supply is necessary for your application or business you should ensure that you have back-up redundancy within the hot water system design. This should ensure the continuity of hot water supply in the event that this water heater were to become inoperable for any reason. We recommend you seek advice from a plumber or specifier about your needs and building back-up redundancy into your hot water supply system.

GOING ON HOLIDAYS

If you plan to be away from home, conserve energy by switching the booster switch “OFF”. It is not necessary to switch off the electrical supply at the power outlet to the solar control unit. Refer to [“To Turn Off The Water Heater”](#) on page 13. Also if the system is not used for a period in excess of four (4) weeks it is recommended the solar collectors be covered.

VICTORIAN CUSTOMERS

Notice to Victorian Customers from the Victorian Building Authority. This water heater must be installed by a licensed person as required by the Victorian Building Act 1993.

Only a licensed person will give you a Compliance Certificate, showing that the work complies with all the relevant Standards. Only a licensed person will have insurance protecting their workmanship for 6 years. Make sure you use a licensed person to install this water heater and ask for your Compliance Certificate.

DOES THE WATER CHEMISTRY AFFECT THE WATER HEATER?

The water heater is suitable for most public water supplies, however some water chemistries may have detrimental effects on the water heater, the solar collectors, components and fittings. Refer to “Water Supplies” on page 20.

If you are in a known harsh water area or you are not sure of your water chemistry, have your water checked against the conditions described on pages 20 to 22.

HOW LONG WILL THE WATER HEATER LAST?

The water heater is supported by a manufacturer’s warranty (refer to page 4). There are a number of factors that will affect the length of service the water heater will provide. These include but are not limited to the water chemistry, the water pressure, the water temperature (inlet and outlet) and the water usage pattern. Refer to “Precautions” on page 16.

MAINTENANCE REQUIREMENTS

MINOR MAINTENANCE EVERY SIX MONTHS

It is recommended minor maintenance be performed every six (6) months. Minor maintenance can be performed by the dwelling occupant.

The minor maintenance includes:

- Operate the easing lever on the temperature pressure relief valve. **It is very important the lever is raised and lowered gently.** Refer to “Relief Valves” on page 8.

⚠ Warning: Water discharged from the temperature pressure relief valve drain line will be hot. Exercise care to avoid any splashing of water by standing clear of the drain line's point of discharge when operating the valve's easing lever.

- Operate the easing lever on the expansion control valve (if fitted). **It is very important the lever is raised and lowered gently.** Refer to “Relief Valves” on page 8.
- Check the drain line from the safe tray (if one is installed) is not blocked.
- Check the status of the LEDs. The green LED should be illuminated (either solid, pulsing or flashing). The red LED should be off. Refer to “Solar Monitor” on page 15 and “Household Maintenance Around the Solar Storage Tank” on page 19.

It is important to ensure the solar controller and circulator are operating correctly, particularly at the onset of the colder winter season. Solar gain will not be achieved and the freeze protection system will be rendered inoperative if the solar controller or circulator are not operating.

MAJOR SERVICE EVERY FIVE YEARS

It is recommended a major service be conducted on the water heater every five (5) years. If an anode replacement is conducted sooner than a major service, then the major service should coincide with the replacement.

⚠ Warning: Servicing of a water heater must only be carried out by a qualified person. Phone Rheem Service or their nearest Accredited Service Agent.

Note: The five year service and routine replacement of any components, such as the anode and relief valves, are not included in the Rheem warranty. A charge will be made for this work. Only genuine replacement parts should be used on this water heater.

The major service includes the following actions:

- Replace the temperature pressure relief valve.
- Inspect and flush the expansion control valve (if fitted). If required, replace the valve.
- Inspect and if required, replace the anode.
If the anode is not replaced, it should be replaced within three years of this service (refer to “Anode Inspection and Replacement” on page 21).
- Check the electric heating unit for excessive calcium build up or corrosion and replace if necessary.
- Check the solar control unit for correct operation.
- Flush and bleed the solar collectors.
- Clean the collector glass.
- Check the insulation on the solar hot and solar cold pipes. If required, insulate exposed pipe work and repair or replace degraded insulation.
- Visually check the unit for any potential problems.
- Inspect all connections.
- Check the drain line from the safe tray (if one is installed) is not blocked.

Note: The solar storage tank may need to be drained during this service. After the completion of the service, the solar storage tank will take some time to reheat the water by solar gain. Depending upon the power supply connection to the booster heating unit, hot water may not be available until the next morning.

HOUSEHOLD MAINTENANCE AROUND THE SOLAR STORAGE TANK

Care should be taken when conducting general household maintenance, such as lawn mowing and grass cutting, around the solar storage tank. Careless use of devices such as a whipper snipper could damage or cut a sensor lead or the electrical cable.

If a sensor lead or the electrical cable is damaged or cut, solar contribution may not be achieved and the freeze protection system may be rendered inoperative. In addition, if the electrical cable has been damaged or cut, wiring may be exposed leading to a dangerous situation.

On a regular basis, inspect around the water heater for insect infestations, such as ants. Insects may look for a warm place to nest, particularly in wet weather. Insects encroaching into or nesting in the water heater and the solar control unit can interfere with the operation of the water heater and also damage components. Spray insecticide around the base of the water heater if necessary to rid the area of insects.

COLLECTOR GLASS

Ensure the glass on your solar collectors is free of dust, salt spray or any other matter which may reduce the effectiveness of the solar collectors. Rainfall should keep the collector adequately clean. It is recommended the collector glass be washed clean at least every three months should adequate rain not have fallen in this period.

Collector glass can be hosed down or if the solar collectors are accessible such as on a trafficable roof, wash the collector glass with water and a soft brush when the solar collectors are cool, such as early in the morning. In extremely dusty areas extra attention may need to be given to keeping the collector glass clean.

Have any trees trimmed which may shade the solar collectors.

Rheem solar collectors have passed the AS/NZS 2712 requirements for resistance to hailstone damage, so it is not normally necessary to fit a guard to a collector. Stone Guards are available to provide a level of protection to the collectors against vandalism or accidental damage. Contact Rheem or your local Rheem Solar Water Heater Distributor for details.

WATER SUPPLIES

This water heater must be installed in accordance with this advice to be covered by the Rheem warranty.

This water heater is manufactured to suit the water conditions of most public reticulated water supplies. However, there are some known water chemistries which can have detrimental effects on the water heater and its operation and / or life expectancy. If you are unsure of your water chemistry, you may be able to obtain information from your local water supply authority. This water heater should only be connected to a water supply which complies with these guidelines for the Rheem warranty to apply.

CHANGE OF WATER SUPPLY

The changing or alternating from one water supply to another can have a detrimental effect on the operation and / or life expectation of a water heater cylinder, a temperature pressure relief valve, a heating unit and a solar collector in an open circuit solar water heater system.

Where there is a changeover from one water supply to another, e.g. a rainwater tank supply, bore water supply, desalinated water supply, public reticulated water supply or water brought in from another supply, then water chemistry information should be sought from the supplier or it should be tested to ensure the water supply meets the requirements given in these guidelines for the Rheem warranty to apply.

ANODE

The vitreous enamel lined cylinder of the water heater is only covered by the Rheem warranty when the total dissolved solids (TDS) content in the water is less than 2500 mg/L and when the correct colour coded anode is used. If an incorrect colour coded anode is used in the water heater, any resultant faults will not be covered by the Rheem warranty. In addition, the use of an incorrect colour coded anode may shorten the life of the water heater cylinder.

The correct colour coded anode must be selected and fitted to the water heater in accordance with the following advice and the [Anode Selection chart](#) on page 20 for the Rheem warranty to apply to the water heater cylinder.

Total Dissolved Solids	Anode colour code
0 – 40 mg/L	Green
40 – 150 mg/L	Green or Black
150 – 400 mg/L	Black
400 – 600 mg/L	Black or Blue
600 – 2500 mg/L	Blue
2500 mg/L +	Blue (no cylinder warranty)

The changing of an anode must be carried out by a qualified person.

Note: Some water analysis reports may state the conductivity of the water rather than the level of total dissolved solids. Conductivity, measured in microsiemens per centimetre ($\mu\text{S} / \text{cm}$), is directly proportional to the TDS content of the water. TDS, in mg / L, is approximately 70% of the conductivity in $\mu\text{S} / \text{cm}$.

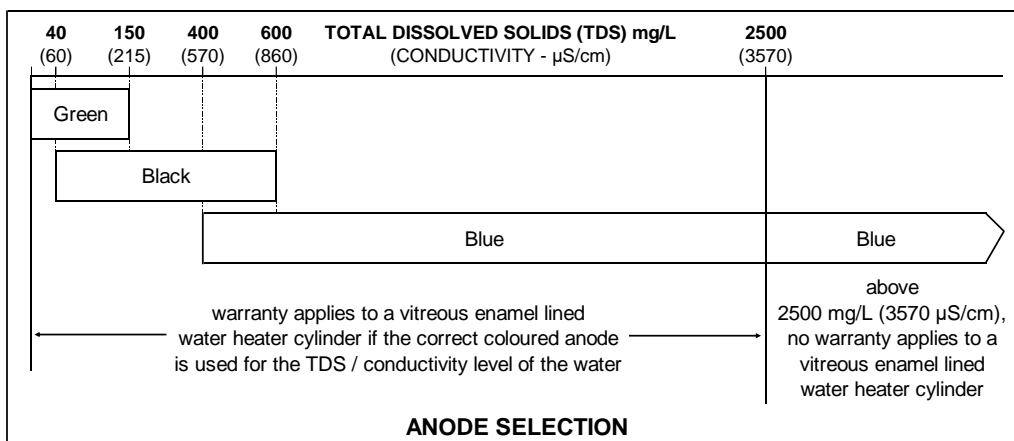

ANODE INSPECTION AND REPLACEMENT

The anode installed in this water heater will slowly dissipate whilst protecting the cylinder. The life of the cylinder may be extended by replacing the anode.

For water supplies which are either softened or desalinated, or where the water supply may alternate between a water tank and a reticulated public supply or another supply, or where there is a variable supply (e.g. from a bore or public reticulated supply from various water sources), the anode must be inspected (and replaced if there is any sign of depletion) within five (5) years of its installation.

For all water supplies, if the anode is not replaced during a major service (refer to “[Major Service Every Five Years](#)” on page 18) then the maximum time after installation when the anode should be replaced for this water heater is eight (8) years.

CAUTION

If the water supply has a TDS greater than 150 mg/L and a green anode has not been changed to a black anode, or if the TDS is greater than 600 mg/L and the anode has not been changed to a blue anode, there is the possibility the anode may become overactive and hydrogen gas could accumulate in the top of the water heater during long periods of no use.

If, under these conditions, the water heater has not been used for two or more weeks the following procedure should be carried out before using any electrical appliances (automatic washing machines and dishwashers) which are connected to the hot water supply.

The hydrogen, which is highly flammable, should be vented safely by opening a hot tap and allowing the water to flow. There should be no smoking or naked flame near the tap whilst it is turned on. Any hydrogen gas will be dissipated. This is indicated by an unusual spurting of the water from the tap. Once the water runs freely, any hydrogen in the system will have been released.

SATURATION INDEX

The saturation index is used as a measure of the water’s corrosive or scaling properties. The saturation index figures stated are calculated using a water temperature of 80°C.

In a corrosive water supply, the water can attack copper parts and cause them to fail.

Where the saturation index is less than -1.0 , the water is very corrosive and the Rheem warranty does not apply to a copper sheathed heating unit or a solar collector in an open circuit solar water heater system. A corrosion resistant heating unit must be used for the Rheem warranty to apply to the heating unit.

In a scaling water supply calcium carbonate is deposited out of the water onto any hot metallic surface.

Where the saturation index exceeds $+0.40$, the water is very scaling. An expansion control valve must be fitted on the cold water line after the non-return valve to protect and for the Rheem warranty to apply to the temperature pressure relief valve and water heater cylinder. Solar collectors in an open circuit solar water heater system should be covered when the water heater is not intended to be used for more than four (4) weeks.

Where the saturation index exceeds $+0.80$, the Rheem warranty does not apply to a standard watts density heating unit or a solar collector in an open circuit solar water heater system. A low watts density heating unit must be used for the Rheem warranty to apply to the heating unit.

Water which is scaling may be treated with a water softening device to reduce the saturation index of the water.

Refer to the [Saturation Index chart](#) on page 22.

Contact Rheem Service or their nearest Accredited Service Agent if a replacement heating unit is required.

Refer to the [cold water connection detail on page 46](#) for the position of the expansion control valve.

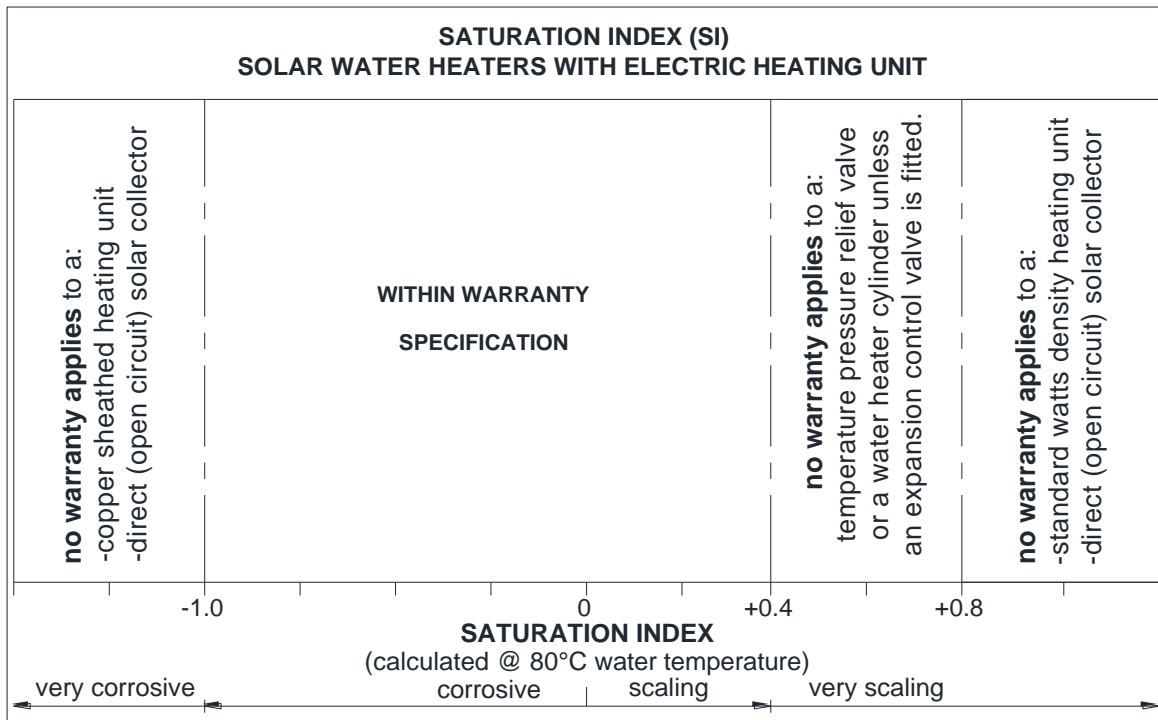

SUMMARY OF WATER CHEMISTRY ADVICE AFFECTING WARRANTY

The water heater, solar collectors and their components are not suitable for certain water chemistries. Those chemistries are listed below. If the water heater is connected at any time to a water supply with the following water chemistry, the Rheem warranty will not cover any resultant faults on the components listed below:

Water Chemistry

- Total Dissolved Solids (TDS) > 2500 mg/L
- Total Dissolved Solids (TDS) not suitable for anode type
- Saturation Index (SI) < -1.0
- Saturation Index (SI) > +0.4
(if an expansion control valve is not fitted)
- Saturation Index (SI) > +0.8

Component

- water heater cylinder
- water heater cylinder
- solar collector
- copper sheathed heating unit
- water heater cylinder
- temperature pressure relief valve
- solar collector
- standard watts density heating unit

SAVE A SERVICE CALL

Check the items below before making a service call. You will be charged for attending to any condition or fault that is not related to manufacture or failure of a part.

NOT ENOUGH HOT WATER (OR NO HOT WATER)

This can occur with new installations and is normally related to some misunderstandings as to the use of the booster heating unit.

- **Insufficient sunlight**

Insufficient sunlight due to cloudy weather during hotter months or low solar energy contribution in colder months may mean the booster heating unit is required to boost more often.

Ensure the booster heating unit is being used as advised. Refer to [“Booster Control”](#) on page 14.

- **Booster heating unit not operating**

Inspect the isolating switch marked “HOT WATER” or “WATER HEATER” at the switchboard and the isolating switch (if one is installed) near the solar storage tank and ensure they are turned on.

Check the timer (if one is installed) and its settings to ensure power is available to the booster heating unit.

Note: Check the electricity supply to which the unit is connected. If on an Off-Peak or time controlled supply, remember heating hours are restricted.

Check the fuse or circuit breaker marked “HOT WATER” or “WATER HEATER” at the switchboard.

- **Solar Control Unit**

Check the power outlet for the solar control unit is switched on.

- **Green LED is off or red LED is flashing on Solar Monitor**

If the green LED is off or the red LED is flashing on the Solar Monitor label, there may be a problem with the solar water heater operation and solar gain is not being achieved. This will result in the booster heating unit operating to provide all of the hot water required.

Switch off the electrical supply at the power outlet to the solar control unit for a few seconds, then switch on again.

If the green LED remains off or the red LED recommences to flash, then count the number of flashes and phone Rheem Service or their nearest Accredited Service Agent to arrange for an inspection.

- **Collectors shaded**

If trees or other objects shade the solar collectors or if the glass is dirty, the effectiveness of the solar collectors will be greatly reduced. Have the trees trimmed or the solar collectors relocated if the obstruction is permanent or clean the collector glass (refer to [“Collector Glass”](#) on page 19).

- **Collector area is too small**

For most installations, the number of solar collectors recommended in Rheem literature has been proven to provide the required solar energy to meet the average family needs. However, in some circumstances, it may be necessary to install an additional solar collector.

- **Air in collectors (no solar gain)**

It is possible under certain conditions, such as when the pipe work has been opened, that air may become trapped in the solar collectors. This will prevent the circulator from moving water around the collector circuit. Have a plumber purge the collector circuit of air.

- **Relief valve running**

Is the relief valve discharging too much water?

Refer to [“Temperature Pressure Relief Valve or Expansion Control Valve Running”](#) on page 24.

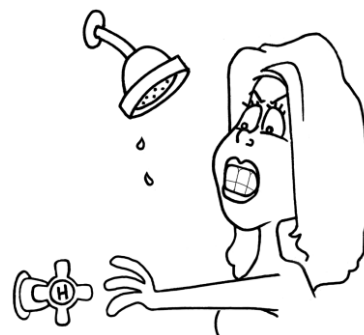

- **Are you using more hot water than you think?**

Is one outlet (especially the shower) using more hot water than you think?

Very often it is not realised the amount of hot water used, particularly when showering. Carefully review the family's hot water usage. As you have installed an energy saving appliance, energy saving should also be practised in the home. Adjust your water usage pattern to take advantage of maximum solar gains.

Have a plumber install a flow control valve to each shower outlet to reduce water usage.

- **Thermostat setting**

Ensure the thermostat setting is appropriate. You may choose to have a licensed electrical worker adjust the thermostat upwards to gain additional hot water capacity when boosting. Refer to "Temperature Adjustment" on page 13.

⚠ Warning: Hotter water increases the risk of scald injury.

- **Water heater size**

Do you have the correct size water heater for your requirements? The sizing guides in the sales literature and on the Rheem website (www.rheem.com.au) suggest average sizes that may be needed.

WATER NOT HOT ENOUGH

You may find that due to heavy hot water usage or low solar energy gain the water temperature may be lower than normally expected. Ensure the booster is being used as advised. If a timer is installed, you will need to carefully plan your use of the booster heating unit to boost the water temperature on such occasions.

A lower water temperature may be noticed in the morning when the booster heating unit has not been energised overnight. This in particular may be experienced during periods of low solar energy gain, or if there has been heavy hot water usage the previous night. If higher temperature water is required, particularly in the morning, then use of the booster heating unit is necessary to raise the temperature of the water in the top section of the cylinder.

If the water heater is connected to an Off-Peak (overnight) electricity supply, then switching to an Extended Off-Peak (overnight and day) supply should be considered. If a timer is being utilised, then a timed boost period in the afternoon prior to the evening usage should be considered.

Refer to "Booster Control" on page 14.

TEMPERATURE PRESSURE RELIEF VALVE OR EXPANSION CONTROL VALVE RUNNING

- **Normal Operation**

It is normal and desirable the temperature pressure relief valve or expansion control valve (if fitted) allows a quantity of water to escape during the heating cycle. This quantity should be equal to approximately 1/50 of the hot water used, as water expands by this volume when heated. However, if it discharges more than a bucket full of water in 24 hours, there may be another problem.

The expansion control valve (if fitted) will discharge water instead of the temperature pressure relief valve as it has a lower pressure rating. A benefit is that energy is conserved as the discharged water is cooler. This valve is installed in the cold water line to the water heater (refer to the [cold water connection diagram](#) on page 46).

- **Continuous dribble**

Try gently raising the easing lever on the relief valve for a few seconds (refer to "Relief Valves" on page 8). This may dislodge a small particle of foreign matter and clear the fault. Release the lever gently.

- **Steady flows for long period (often at night)**

This may indicate the mains water pressure sometimes rises above the designed pressure of the water heater. Ask your installing plumber to fit a pressure limiting valve.

⚠ Warning: Never replace the relief valve with one of a higher pressure rating.

- **Heavy flows of hot water from the temperature pressure relief valve until water heater is cold - then stops until water reheats**

The water heater **must** be switched off at the isolating switch or switchboard. Phone Rheem Service or their nearest Accredited Service Agent to arrange for an inspection.

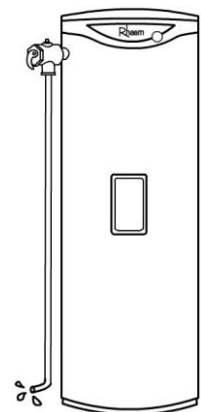

GREEN LED IS NOT ILLUMINATED ON SOLAR MONITOR

Check the power outlet for the solar control unit is switched on.

If the power outlet for the solar control unit is switched on, switch off for a few seconds and then switch on again. If the green LED remains off there may be a fault with the water heater. Phone Rheem Service or their nearest Accredited Service Agent to arrange for an inspection.

RED LED ILLUMINATED ON SOLAR MONITOR

The illumination of the red LED does not necessarily mean there is a fault with the system. A constant glow or rapid pulsing of the red LED indicates an operational mode of the water heater.

Constant Glow

When the water heater has entered Over-temperature operation, the water in the solar collectors will continue to gain heat whilst solar energy is still available. The red LED will commence to emit a constant glow when sufficient solar energy has been received to activate the circulator. This indicates a build-up in temperature of the water in the solar collectors and does not represent a fault. The red LED will stop glowing when the circulator has moved the excess energy from the solar collectors to the solar storage tank.

When eight Over-temperature cycles have been completed and if solar energy is still available, the red LED will emit a constant glow until either a reasonable quantity of hot water is drawn from a tap or the water in the solar collectors loses energy and cools as the available solar energy is reduced, such as when the sun becomes lower in the sky in the late afternoon / early evening or the sky becomes very cloudy.

Refer to [“Over-temperature operation”](#) on page 11.

Rapid Pulsing

During Normal operation the red LED will rapid pulse if the temperature difference between the hot sensor and cold sensor is high due to excess heat in the solar collectors. This may not represent a fault. The rapid pulsing of the red LED will cease as the water circulates transferring the excess heat from the solar collectors to the solar storage tank and the temperature difference between the hot sensor and cold sensor reduces. This should be within four (4) to five (5) minutes, but may take up to ten (10) minutes.

If the red LED continues to emit a rapid pulse for longer than ten (10) minutes, switch off the electrical supply at the power outlet to the solar control unit for a few seconds, then switch on again. If the red LED continues to emit a rapid pulse for longer than ten (10) minutes, phone Rheem Service or their nearest Accredited Service Agent to arrange for an inspection.

Series of Flashes

If the red LED is flashing this indicates there may be a fault with the water heater. The red LED may emit from three to six flashes in each series of flashes with a 2 second interval between each series.

If the red LED emits a series of flashes, switch off the electrical supply at the power outlet to the solar control unit for a few seconds, then switch on again. If the red LED illuminates again, then count the number of flashes and phone Rheem Service or their nearest Accredited Service Agent to arrange for an inspection.

CIRCULATOR OPERATES AT NIGHT

The circulator can operate during periods of no solar energy, usually at night, under two operational modes of the water heater. This is by design and does not indicate a fault.

Freeze Protection operation: The circulator will activate (green LED rapid pulse or 3 flashes) if the water temperature in the solar collectors approaches freezing point. This occurs in very cold conditions, such as overnight and very early in the morning before sunrise. The purpose of the Freeze Protection operation is to prevent freezing of water in the solar collectors and solar pipe work. The circulator will remain on for some minutes and until the hot sensor measures a water temperature at a safe level above freezing from the storage tank. This process will repeat whenever the water temperature in the solar collectors approaches freezing point. Refer to [“Freeze Protection operation”](#) on page 11.

Night Time Cooling operation: The circulator will activate (green LED rapid pulse or 3 flashes) if the water heater has entered Over-temperature operation during that day. This can occur during periods of higher solar energy or lower hot water usage. Excess solar energy gained will be dissipated through the solar collectors until the water temperature in the solar storage tank decreases to a desired 60°C to 70°C. The circulator may remain on for some time. Refer to [“Night Time Cooling operation”](#) on page 11.

NOISE FROM THE SOLAR COLLECTORS

During periods of higher solar radiation or lower hot water usage and the solar storage tank is full of hot water, the water heater may undergo Over-temperature operation (refer to “Over-temperature operation” on page 11). If this mode of operation has occurred and the circulator has deactivated, the water in the solar collectors will continue to gain heat and increase in pressure when solar radiation is still available. This increase in heat and pressure is greater when higher performing selective surface solar collectors are installed compared to non-selective surface collectors.

When a hot tap is opened, this pressure is released and the high temperature water may turn to steam creating a sudden and loud rumbling noise and even a rattling or banging noise of the solar collectors against the roof cladding material. This results from the higher level of solar radiation and the water in the solar storage tank being at its maximum temperature and is not caused by a fault with the solar water heater.

COLLECTOR GLASS

The Rheem warranty **DOES NOT** cover breakage of solar collector glass. Check your household insurance policy covers collector glass breakage.

⚠ Warning: No attempt should be made to remove or replace broken collector glass.

The collector glass is not offered as a replacement part. Should the solar collector require replacement, contact Rheem Service or their nearest Accredited Service Agent.

HIGHER THAN EXPECTED ELECTRICITY BILLS

With the installation of your new solar hot water system, maximum electrical energy savings can be achieved with careful planning of hot water usage. Should you at any time feel your electricity bill is higher than expected, we suggest you check the following points:

- Is the relief valve running excessively?

Refer to “Temperature Pressure Relief Valve or Expansion Control Valve Running” on page 24.

- Is one outlet (especially the shower) using more hot water than you think?

Refer to “Not Enough Hot Water” on page 23.

- Is there a leaking hot water pipe, dripping hot water tap, etc?

Even a small leak will waste a surprising quantity of hot water and energy. Replace faulty tap washers, and have a plumber rectify any leaking pipe work.

- Are you using the booster heating unit properly?

Refer to “Booster Control” on page 14.

- Has there been an increase in hot water usage?

An increase in hot water usage may result in an increase in booster operation.

- Has your water heating tariff rate been increased by your electricity retailer since your previous bill?

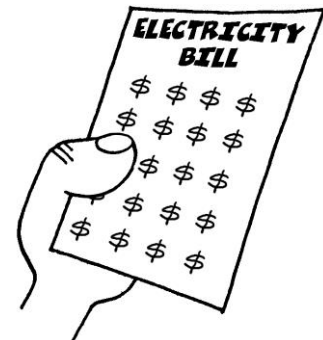

ELECTRICITY SUPPLY AND TARIFF

The hours of availability for the electrical supply and the tariff to which your solar water heater is connected will play an important role in the overall effectiveness of the system. It is important you are aware of the hours of electricity supply to enable you to take full advantage of the boosting period, i.e. Domestic / Continuous or Time of Use, Extended Off-Peak (overnight and day) or extended time controlled, or Off-Peak (overnight) or time controlled. The electricity tariff will impact on the operating costs of the system. Time controlled tariffs are generally cheaper than a continuous supply tariff and result in lower running costs.

IF YOU HAVE CHECKED ALL THE FOREGOING AND STILL BELIEVE YOU NEED ASSISTANCE, PHONE RHEEM SERVICE OR THEIR NEAREST ACCREDITED SERVICE AGENT.

INSTALLATION – SYSTEM

THIS WATER HEATER IS NOT SUITABLE FOR POOL HEATING.

SOLAR COLLECTORS

The system is suitable for installation with Rheem NPT200, LCS or CSA2007 solar collectors.

In Australia, systems with NPT200 solar collectors are suitable for installation in all climate zones. Collectors installed at an orientation greater than 60° from true north may require an additional collector to ensure adequate solar performance.

In Australia for climate zones 1, 2, and 3 there is a risk that systems with selective surface LCS or CSA2007 solar collectors may over perform. In these zones, systems with 2 or more LCS or CSA2007 solar collectors should be installed at orientations between 60° and 90° from true north only.

In climate zone 4, systems with selective surface LCS or CSA2007 solar collectors provide optimum performance compared with non-selective surface collectors, particularly in the months of lower solar radiation.

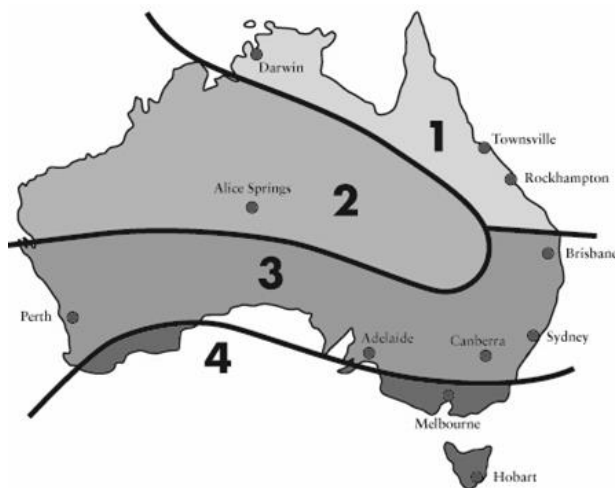

IMPORTANT NOTES

- Working on roofs is and should always be considered a hazardous activity, particularly early in the morning, late in the evening, when the roof is wet or during and after periods of rain.
- All work must be carried out in accordance with Local, State and Federal Occupational Safety, Health and Welfare Regulations. In particular, the requirements for safety whilst manual lifting, working at heights and on roofs.
- Installers must be competently trained in:
 - Height Hazard Assessment
 - Working at Height Procedures
 - Assessment / Use / Wearing of correct height safety equipment (harnesses etc.)
 - All other relevant safety factors specific to the installation and maintenance work to be compliant with suitable Occupational, Health and Safety Regulations / Codes.
- All relevant permits shall be obtained from the regulatory authorities before commencing work to install the solar hot water system.
- All work carried out must be performed by appropriately qualified tradespeople or be suitably supervised for trades assistant duties.
- Every care must be taken to protect and warn occupants of the building and the public from personal injury which may occur from falling tools, roof materials, fittings or any other hazards of a general nature.
- Advise the occupants of any inconvenience which may occur due to disconnection of existing water and electrical supplies.
- The connection, attachment, integration or general association of other equipment or parts which either directly or indirectly affect the operation or performance of this equipment could void the Rheem warranty.
- All packaging materials must be removed from the solar storage tank prior to its installation. This includes the removal of the cardboard base of the carton from the underside of the solar storage tank.

INSTALLATION STANDARDS

The water heater must be installed:

- by a qualified person, and
- in accordance with the installation instructions, and
- in compliance with the Plumbing Code of Australia (PCA), Standards AS/NZS 3500.4 and AS/NZS 3000, and all local codes and regulatory authority requirements.

⚠ Warning: This water heater may deliver water at high temperature. Refer to the Plumbing Code of Australia, local requirements and these installation instructions to determine if additional delivery temperature control is required. Refer to **“Hot Water Delivery”** on page 31.

Victorian Installers

Notice to Victorian Installers from the Victorian Building Authority if this solar water heater is installed in a new Class 1 dwelling in the State of Victoria. The system model number is to be recorded on the Certificate of Compliance.

It is also a requirement to provide the householder with permanent documentation recording the system model number exactly as it is shown in the ‘VEET Product Register’ published by the Essential Services Commission in Victoria. See www.vee-registry.vic.gov.au/Public/ProductRegistrySearch.aspx. This documentation may be in the form of an indelible label adhered to the solar storage tank, or other suitable form placed in an accessible location, such as the meter box, for later inspection.

FREEZE PROTECTION

The system has a level of freeze protection designed to guard the system against damage from freeze conditions. The system must be installed with the full length of the solar hot and solar cold pipes insulated and power must be available at the solar control unit to offer protection against freeze damage (refer to **“Warning: Plumber Be Aware”** on page 44). Freeze conditions occur below 6°C.

The system is not recommended for installation above 400 metres altitude. A system has NO WARRANTY for freeze damage when installed above 400 metres altitude or if the solar hot and solar cold pipes are not insulated in accordance with the installation instructions or if power is not available at the solar control unit (refer to **“Terms of the Rheem Warranty”** on page 4).

Note: The Rheem warranty against freeze damage applies only to systems installed in Australia.

WATER HEATER APPLICATION

This water heater is designed for use in a single family domestic dwelling for the purpose of heating potable water. Its use in an application other than this may shorten its life.

If this water heater is to be used where an uninterrupted hot water supply is necessary for the application or business, then there should be back-up redundancy within the hot water system design. This should ensure the continuity of hot water supply in the event that this water heater was to become inoperable for any reason. We recommend you provide advice to the system owner about their needs and building back-up redundancy into the hot water supply system.

This water heater is designed to be installed as an electric boosted solar water heater with its booster heating unit connected to a power supply, however it may be installed with an in-series continuous flow or storage booster.

If this water heater is installed with an in-series booster, then the electric booster heating unit will not be connected to a power supply and the references to the electric booster heating unit, thermostat and boosting controls in these installation instructions will not be applicable to the installation.

Note: AS 3498 requires that a water heater provides the means to inhibit the growth of Legionella bacteria in potable water. This water heater can satisfy this AS 3498 requirement provided the electric booster is energised for a sufficient period each day and the electric booster thermostat setting is 60°C or higher.

If this water heater is installed with an in-series continuous flow gas booster, then this requirement of AS 3498 can be satisfied provided the booster is energised, its preset outlet temperature setting is 70°C or higher and a remote temperature controller or an EZiSET kit is not used.

If this water heater is installed with an in-series storage booster, then this requirement of AS 3498 can be satisfied provided the storage booster is energised and its thermostat setting is 60°C or higher.

Installing the Water Heater as a Pre-Heater

This water heater can be used as a pre-heater to a new or existing in-series booster water heater provided:

- The in-series booster water heater is;
 - thermostatically-controlled, and
 - suitable to be used as an in-series booster water heater for a solar water heater.
- The operating pressures of the two water heaters are compatible or reduced to the lower rated of the two water heaters.
- The in-series booster water heater has sufficient thermal capacity to supply the hot water requirements of the application during periods of low or no solar gain.
- A temperature-operated bypass valve is installed prior to the in-series water heater if this water heater has either an over temperature energy cut-out which can be permanently disabled by high temperature hot water or a maximum recommended inlet supply temperature less than the temperature of water which can be supplied by this solar water heater.

It will be necessary to check with the manufacturer of the in-series water heater as to its suitability for use as an in-series booster to this solar water heater.

INSTALLATION – SOLAR STORAGE TANK

SOLAR WATER HEATER STORAGE TANK LOCATION

The solar storage tank is suitable for either outdoor or indoor installation. Whether located outdoor or indoor, the solar storage tank should be installed close to the most frequently used outlet and its position chosen with safety and service in mind.

Consideration must also be given to the position of the solar storage tank in relation to the solar collectors. There are limitations on the maximum length of the solar hot and solar cold pipes between the solar storage tank and the solar collectors. Refer to “Solar Collector Location” on page 40, to “Pipe Lengths” on page 42 and to “Maximum Height to Collectors” on page 43.

Clearance must be allowed for servicing of the solar storage tank and solar control unit. The solar storage tank must be accessible without the use of a ladder or scaffold. Make sure the temperature pressure relief valve lever is accessible and the front cover, thermostat, booster heating unit, controller cover, PCB and circulator can be removed for service.

You must be able to read the information on the rating plate. If possible leave headroom of one solar storage tank height so the anode can be inspected or replaced. Remember you may have to remove the entire solar storage tank later for servicing.

The solar storage tank is to be installed at ground or floor level and must stand vertically upright on a stable base as acceptable to local authorities. The base of the solar storage tank is made of corrosion resistant material, and it may be placed directly in contact with the supporting surface. It is not necessary to allow for free air circulation under the base of the solar storage tank.

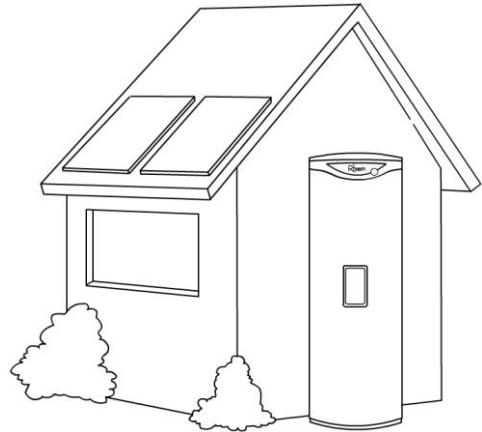

Note: The solar storage tank should not be placed in direct contact with a concrete surface that is less than two months old and not fully cured as this may attack the metal coating of the solar storage tank base. A moisture barrier should be used between the two surfaces in this instance. The barrier should extend at least 100 mm from the solar storage tank and may be trimmed after two months.

Remember all local authorities have regulations about putting water heaters into roof spaces.

SAFE TRAY

Where damage to property can occur in the event of the solar storage tank leaking, the solar storage tank must be installed in a safe tray. Construction, installation and draining of a safe tray must comply with AS/NZS 3500.4 and all local codes and regulatory authority requirements. AS/NZS 3500.4 also has particular requirements when a safe tray must be installed.

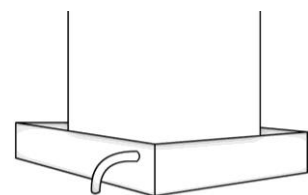

MAINS WATER SUPPLY

Where the mains water supply pressure exceeds that shown in the table, an approved pressure limiting valve is required and should be fitted as shown in the cold water connection diagram on page 46.

Model	271, 325, 410
Temperature pressure relief valve setting	1000 kPa
Expansion control valve setting *	850 kPa
Maximum mains supply pressure	
With expansion control valve	680 kPa
Without expansion control valve	800 kPa
Minimum mains supply pressure	200 kPa

* Expansion control valve not supplied with the water heater.

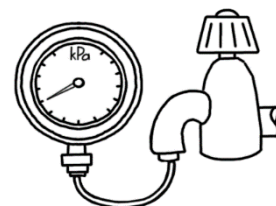

TANK WATER SUPPLY

If the water heater is supplied with water from a tank supply and a minimum water supply pressure of 200 kPa at the water heater cannot be achieved, then a pressure pump system must be installed to allow the collector circuit system to operate. Care must be taken to avoid air locks. The cold water line from the supply tank should be adequately sized and fitted with a full flow gate valve or ball valve.

HOT WATER DELIVERY

This water heater can deliver hot water at temperatures which on occasion could exceed 75°C, sufficiently hot to cause severe scalding. Water at this temperature may be plumbed to fixtures where water hotter than 50°C is allowed, such as the kitchen and laundry.

The installing plumber may have a legal obligation to ensure the installation of this water heater meets the water temperature delivery requirements of the Plumbing Code of Australia so that heated water delivered to fixtures and appliances used primarily for personal hygiene is at a temperature which is unlikely to scald.

It is necessary and we recommend that a temperature limiting device be fitted between the water heater and the fixtures and appliances used primarily for personal hygiene such as in a bathroom, ensuite, public amenities or other ablution areas, to reduce the risk of scalding.

The temperature limiting device must be of a type suitable for use with a solar water heater. Refer to the manufacturer’s specifications of the temperature limiting device.

Where a temperature limiting device is installed adjacent to the solar water heater, the cold water line to the temperature limiting device can be branched off the cold water line either before or after the isolation valve and pressure limiting valve to the solar storage tank, but it **MUST BE** before a non-return valve. If an expansion control valve is required, it must always be installed after the non-return valve and be the last valve prior to the solar storage tank.

Solar control unit, PN 052295 (introduced in the solar controller kit PN 299293 in August 2018) contains a non-return valve at the inlet to the circulator. For a water heater fitted with this solar control unit, the non-return valve installed on the cold water line to the tank, and after the cold water branch to a temperature limiting device, is not required to be a dual check valve type.

If a combination isolation valve and non-return valve (duo or trio valve) is installed on the cold water line to the solar water heater and the cold water line to the temperature limiting device branches off after this valve, then a second non-return valve must be installed between the cold water branch and the solar storage tank.

If a pressure limiting valve is installed on the cold water line to the solar water heater and the cold water line to a temperature limiting device branches off before this valve or from another cold water line in the premises, then a pressure limiting valve of an equal pressure setting may be required prior to the temperature limiting device.

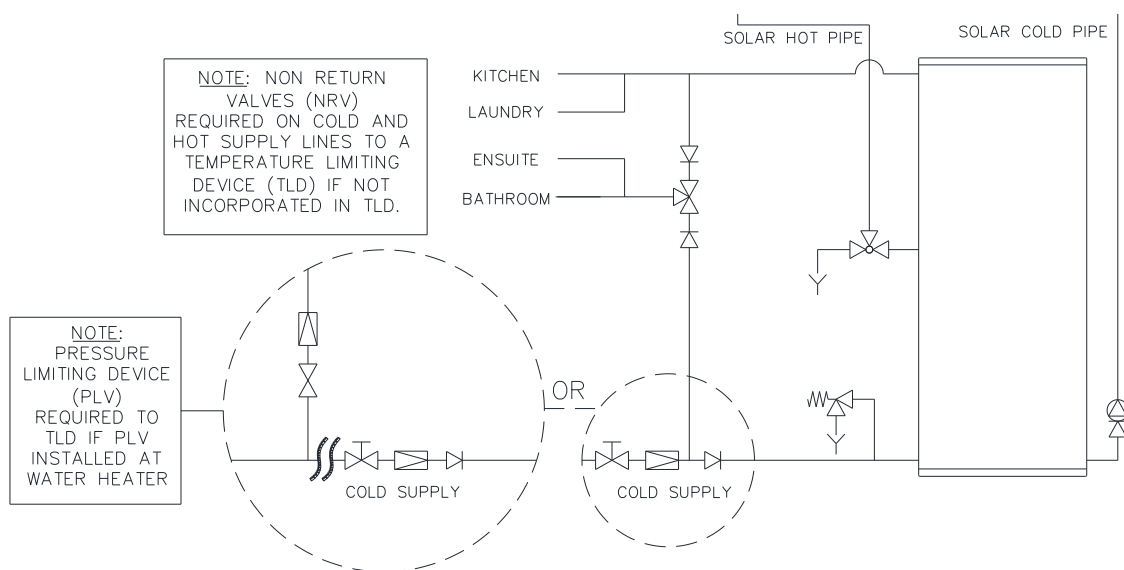

Two Temperature Zones Using a Temperature Limiting Device

CIRCULATED HOT WATER FLOW AND RETURN SYSTEM

The solar storage tank of a solar water heater should not be installed as part of a circulated hot water flow and return system in a building. The benefits of solar gain will be significantly reduced.

In-tank electric boosting

If this solar water heater has its electric heating unit connected for in-tank boosting and a circulated flow and return system is required, it is necessary to install a secondary water heater supplied from the solar water heater. The flow and return lines connect to the secondary water heater, not the solar storage tank. The secondary water heater makes up for the pipe heat loss in the flow and return system and must be able to provide a hot water outlet temperature of at least 60°C.

Refer to the diagram **Circulated Hot Water Flow and Return System – Solar Water Heater with In-tank Boosting** on page 32.

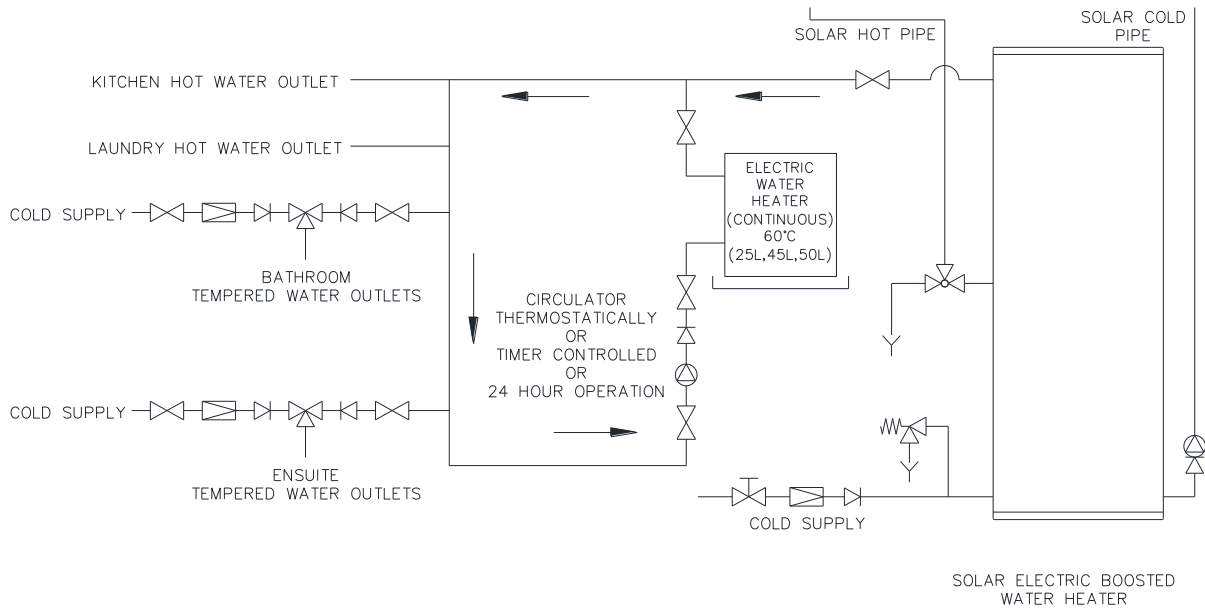

NOTE: A PLV IS REQUIRED TO BE INSTALLED ON THE COLD SUPPLY LINE TO THE TEMPERING VALVE IF A PLV IS INSTALLED ON THE COLD SUPPLY LINE TO THE WATER HEATER.

Circulated Hot Water Flow and Return System – Solar Water Heater with In-tank Boosting

In-series boosting

If this solar water heater does not have its electric heating unit connected for in-tank boosting and is installed as a solar pre-heater to an in-series booster water heater, then the booster water heater can be used as the secondary water heater so long as it is able to provide a minimum hot water outlet temperature of at least 60°C and it is not connected to an Off-Peak or time controlled electricity supply. It is necessary to connect the flow and return lines to the in-series booster and not to the solar storage tank.

Refer to the diagram **Circulated Hot Water Flow and Return System – Solar Water Heater with In-series Boosting** on page 33.

If the in-series water heater is a continuous flow water heater, the circulator must be:

- sized and set to provide a minimum flow rate of 3.0 L/min through the circulated hot water flow and return system, and
- either thermostatically and / or timer controlled.

The circulator **must not** be set to operate continuously, i.e. 24 hours per day.

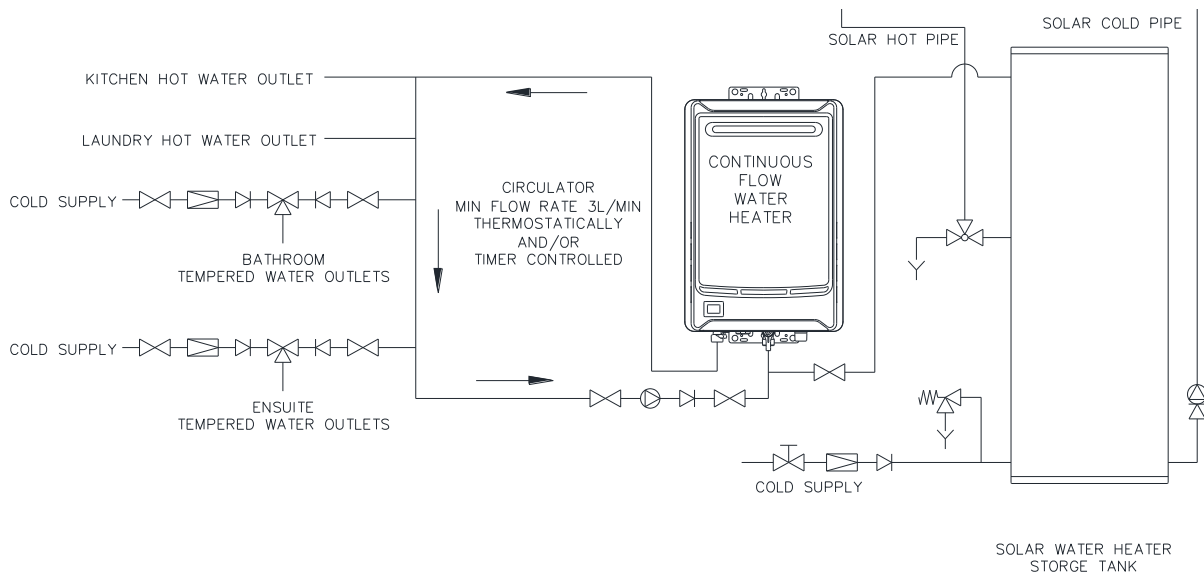

NOTE: A PLV IS REQUIRED TO BE INSTALLED ON THE COLD SUPPLY LINE TO THE TEMPERING VALVE IF A PLV IS INSTALLED ON THE COLD SUPPLY LINE TO THE WATER HEATER.

Circulated Hot Water Flow and Return System – Solar Water Heater with In-series Boosting

Temperature Settings

- AS 3498 requires that a water heater provides the means to inhibit the growth of Legionella bacteria in potable water. To meet this requirement of AS 3498:
 - A solar storage tank with its electric heating unit connected for in-tank boosting, and the secondary water heater must always have their thermostats set to at least 60°C
 - An in-series storage water heater must always have its thermostat set to at least 60°C
 - An in-series continuous flow water heater must always have its preset outlet temperature setting set to at least 70°C
- Water should not be circulated from a water heater with a temperature setting of less than 60°C.
- The return water temperature to the water heater must not be less than 55°C.

If the return water temperature decreases by more than 5°C due to heat loss from the hot water ring main, the preset outlet temperature setting or thermostat setting of the secondary water heater or in-series water heater must be set to above 60°C to ensure the return water temperature is not less than 55°C.

Temperature Limiting Device

A temperature limiting device cannot be installed in circulated hot water flow and return pipe work. The tempered water from a temperature limiting device cannot be circulated. Where a circulated hot water flow and return system is required in a building, a temperature limiting device can only be installed on a dead leg, branching off the circulated hot water flow and return pipe.

If circulated tempered water were to be returned back to the water heater, depending on the location of the return line connection on the water supply line to the water heater, then either:

- water will be supplied to the cold water inlet of the temperature limiting device at a temperature exceeding the maximum recommended water supply temperature, or
- when the hot taps are closed no water will be supplied to the cold water inlet of the temperature limiting device whilst hot water will continue to be supplied to the hot water inlet of the temperature limiting device.

These conditions may result in either water at a temperature exceeding the requirements of AS/NZS 3500.4 being delivered to the hot water outlets in the ablution areas, or the device closing completely and not delivering water at all, or the device failing. Under either condition, the operation and performance of the device cannot be guaranteed.

REDUCING HEAT LOSSES

The cold water line to and the hot water line from the water heater must be insulated in accordance with the requirements of AS/NZS 3500.4. The insulation must be weatherproof and UV resistant if exposed.

The full length of the solar hot and solar cold pipes between the solar storage tank and the solar collectors **MUST BE** insulated. Refer to “Warning: Plumber Be Aware” on page 44.

BOOSTER HEATING UNIT

The booster heating unit is for heating the water at times of low solar energy gain, such as during very cloudy or rainy weather, or during the colder months. Refer to “Connections – Electrical” on page 49 for electrical connection requirements and control options of the booster heating unit.

If this water heater is installed with an in-series booster, then the electric booster heating unit in the solar storage tank will not need to be connected to a power supply.

ANODE

The vitreous enamel lined cylinder of the water heater is only covered by the Rheem warranty when the total dissolved solids (TDS) content in the water is less than 2500 mg/L and when the correct colour coded anode is used. If an incorrect colour coded anode is used in the water heater, any resultant faults will not be covered by the Rheem warranty. In addition, the use of an incorrect colour coded anode may shorten the life of the water heater cylinder.

The correct colour coded anode for the water supply being used must be selected and fitted to the water heater for the Rheem warranty to apply to the water heater cylinder (refer to “Water Supplies” on page 20 and the Anode Selection table on page 20). The black anode is typically fitted as standard.

If an incorrect anode is used, there is also the possibility the anode may become overactive and hydrogen gas could accumulate in the top of the water heater during long periods of no use. In areas where this is likely to occur, the installer should instruct the householder on how to dissipate the gas safely (refer to “Caution” on page 21).

SADDLING - PIPE WORK

To prevent damage to the cylinder when attaching pipe clips or saddles to the solar storage tank jacket, we recommend the use of self-drilling screws with a maximum length of 13 mm. Should pre drilling be required, extreme caution must be observed when penetrating the jacket of the solar storage tank.

Note: If the cylinder is damaged as a result of attaching pipe clips or saddles to the jacket, any resultant faults will not be covered by the Rheem warranty.

DIMENSIONS AND TECHNICAL DATA

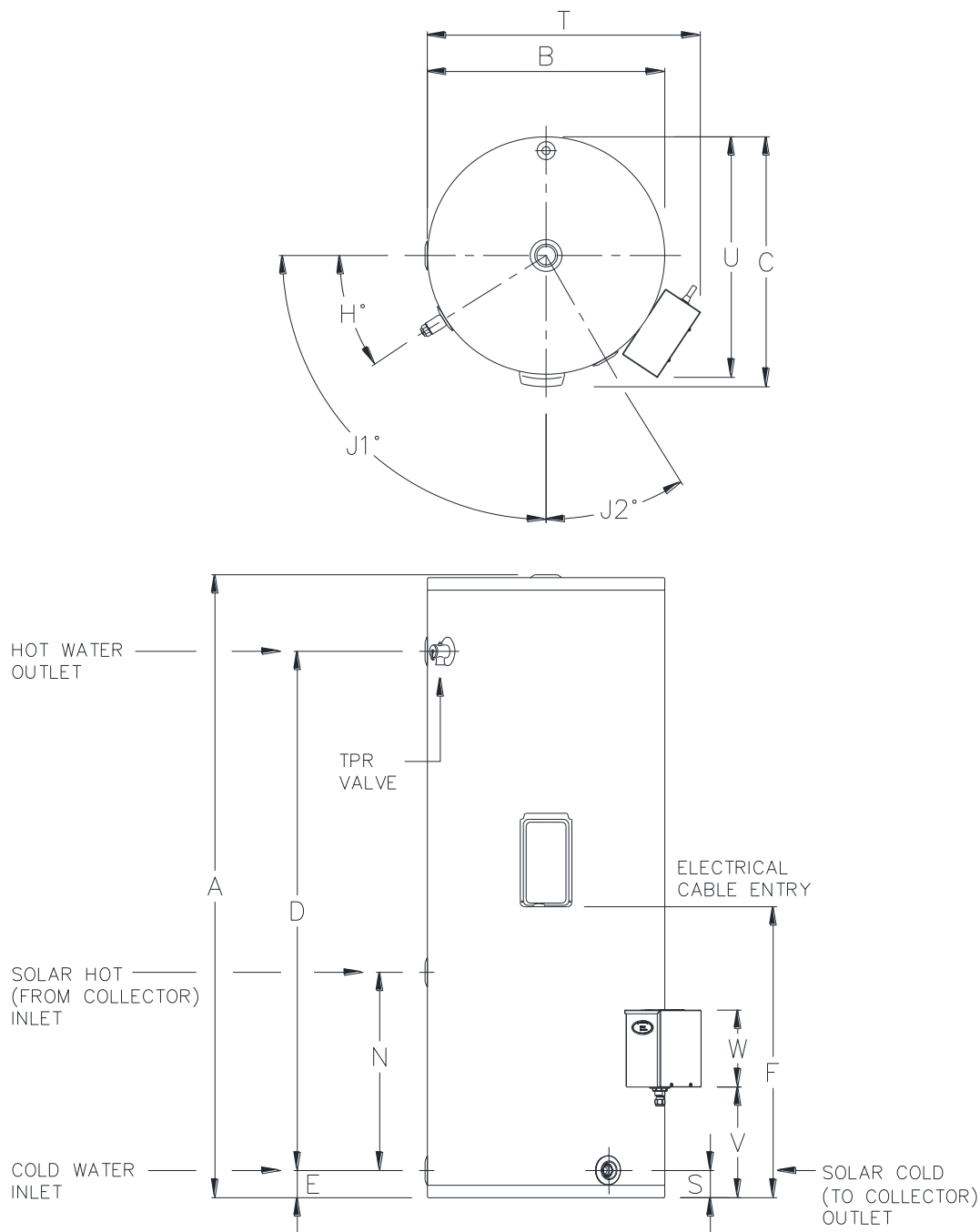

Model (single mid element)	Nominal Storage Capacity	Boost Capacity	Tank Mass (kg)	
			Empty	Full
511271	270 litres	140 litres	82	352
511325	325 litres	170 litres	92	428
511410	410 litres	220 litres	115	531

Dimensions (mm)	A	B	C	D	E	F	H	J1	J2	N	S	T	U	V	W
511271	1395	640	680	1112	73	588	32°	88°	32°	412	73	737	647	302	210
511325	1640	640	680	1357	73	710	32°	88°	32°	481	73	737	647	302	210
511410	1840	690	730	1519	81	795	30°	82°	30°	532	81	751	729	302	210

Tank product number has a two digit suffix to denote the heating unit size, where 07 = 3.6 kW.
 Technical data is subject to change.

TYPICAL INSTALLATION (SINGLE ELEMENT) – OUTDOOR LOCATION

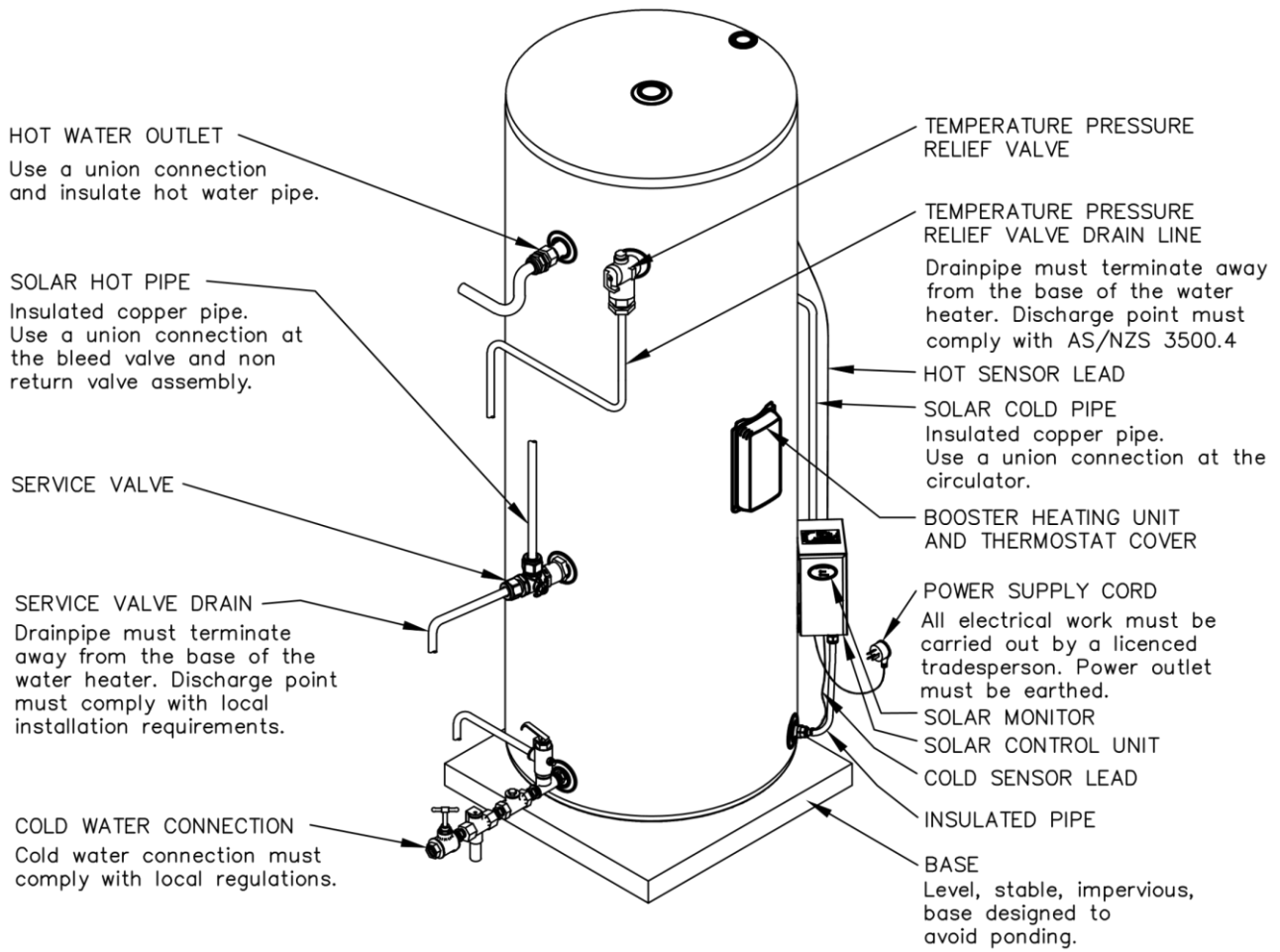

TYPICAL INSTALLATION (SINGLE ELEMENT) – INDOOR LOCATION

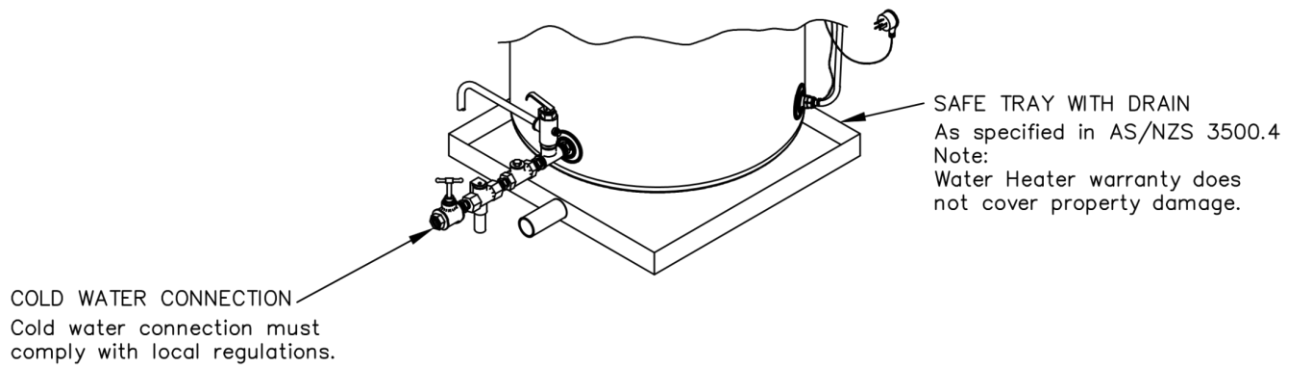

INSTALLATION – SOLAR CONTROL UNIT

The solar control unit is designed to be mounted on the side of the solar storage tank, with its location above and offset from the solar cold water outlet. The solar control unit and components to enable the connection of the collector circuit pipe work to the tank are supplied in a kit (PN 299293) separate to the tank. The solar control unit PN 052295 (introduced in the solar controller kit PN 299293 in August 2018) contains a non-return valve at the inlet to the circulator.

The solar control unit, supplied with a 1.8 metre power cord, requires a 220 V - 240 V a.c. 50 Hz general purpose outlet (GPO) located within 1.2 metres of its installation. The GPO must have a continuous power supply originating from a circuit other than the water heater circuit. The GPO is required to be weatherproof if installed outdoors (refer to “Connections – Electrical” on page 49).

The solar control unit incorporates a circulator to circulate the water between the solar storage tank and the solar collectors. The solar control unit controls the operation of the circulator, and governs the flow rate through the collector circuit. This is achieved via the hot and cold sensors and differential controller programming providing control over the operation of the circulator.

Note: There is no provision for nor is adjustment to the solar control unit required.

Part No	Kit Components and Description - Controller Kit	299293
126619	Installation instructions solar controller kit	1
052295	Control unit solar pumped assembly	1
080031	Screws No 8 x 13 mm	4
220654	Valve service 3-way solar assembly, consisting of: 1 x service valve 3-way solar 2 x nut compression ½” 2 x olive compression copper ½”	1
331658	union body R ¾ M x DN15 olive	1
331655	nut compression DN15 Rye 10090	1
331656	olive compression copper DN15	1
070896	Pipe cold 270 325 410 Ioline preformed tube ½” x 350 mm long	1
180073	Insulation pipe 13 mm ID x 280 mm long	1
090281	Insulation pipe 35 mm ID x 80 mm long	2
080228	Cable tie black 250 – 300 mm x 4.8 mm	6
088065	Fitting union male ½” C x ½” C Rye 4930, consisting of: 1 x hex nipple brass ½” x ½” 2 x nut compression ½” 2 x olive compression copper ½”	1

Notes

- Care must be taken when mounting the solar control unit to the side of the solar storage tank. Use the self-tapping screws provided. If the cylinder is damaged as a result of mounting the solar control unit to the jacket, any resultant faults will not be covered by the Rheem warranty (refer to “Saddling - Pipe Work” on page 34).
- All pipe work must be purged and cleared of foreign matter before connection and before attempting to operate the water heater.
- It is important to connect the solar hot and solar cold pipes to the correct connections at the solar storage tank and solar control unit.
- Connect the solar hot and solar cold pipes to the solar storage tank and solar control unit using only the fittings supplied.
- All olive compression fittings must use brass or copper olives.
- Use an approved thread sealant such as Teflon tape on all threaded joints. Conetite or O-ring fittings do not require a thread sealant.

SOLAR STORAGE TANK WITH RAISED SOLAR HOT INLET

Numbers in parentheses refer to items on diagram on page 39 for [single element models](#).

To mount the solar control unit on the solar storage tank and connect the solar cold pipe:

- Fit the union R 3/4 M x DN15 (2) to the solar cold water outlet of the solar storage tank.
- Connect the DN15 preformed pipe (3), pre-insulated with the 280 mm long x 13 mm diam insulation (10), to the union (2) at the solar cold water outlet and finger tighten using the compression nut (4) and olive (5) provided, ensuring the straight end is orientated upwards.
- Undo the compression nut (4) and olive (5) from the underside of the solar control unit (6) and place over the end of the DN15 preformed pipe (3).
- Locate the solar control unit (6) in an upright position by connecting the DN15 preformed pipe (3) to the union at the **inlet** of the circulator on the underside of the solar control unit and finger tighten using the compression nut (4) and olive (5).
- Secure the solar control unit (6) to the solar storage tank using the four self-tapping screws (7) provided.
- Tighten the compression nuts (4) on both ends of the preformed pipe (3) using a spanner.
- Disassemble the fitting union (1). Place a compression nut and olive over the end of the copper pipe protruding from the side of the solar control unit (6) and the other compression nut and olive over the end of the solar cold pipe (to the collector).
- Connect the solar cold pipe (to the collector) to the pipe from the solar control unit (6) using the nipple from the fitting union (1) and the compression nuts and olives.

Note: A press type fitting **must not** be used to join the solar cold pipe to the pipe from the solar control unit.

- Clip the cold sensor (8) over the end of the preformed pipe adjacent to the union (2) at the solar cold outlet connection.
- Insulate the lower end of the preformed pipe (3), cold sensor and union (2), with an 80 mm long x 35 mm ID piece of insulation (11) and secure with two cable ties (12).
- Connect the hot sensor lead from the solar collector installation to the hot sensor cable connector at the side of the solar control unit (6). The hot sensor lead is supplied in the collector installation kit and the procedure for its installation is in the collector installation kit's installation instructions.

Bundle up any excess hot sensor lead and tie off in a location where it won't sustain damage, such as tied to the outside of the insulation on the solar cold pipe.

Note: Ensure the hot sensor lead is not in direct contact with the solar hot or solar cold pipe work at any point of the collector circuit, otherwise damage to the sensor lead can occur due to the high temperatures which can be experienced within the pipe work. Damage to the hot sensor lead can result in solar gain not being achieved and the freeze protection system being rendered inoperative. The hot sensor lead may be cable tied to the outside of the insulation on the solar pipe work.

To connect the solar hot pipe to the solar storage tank:

- Fit the service 3-way solar valve assembly (9) to the solar hot water inlet of the solar storage tank. Ensure the service valve inlet is pointing vertically upwards or horizontally towards the rear of the storage tank so the opening and closing device remains easily accessible. Refer to the exploded view [diagram](#) on page 39 for position.
- Connect the solar hot pipe (from the collector) to the inlet of the service valve assembly (9) using the compression nut and olive provided with the valve.
- Connect a DN15 copper drain line to the service valve drain outlet using the compression nut and olive provided with the valve. The drain line must carry the discharge clear of the water heater and solar control unit and safely to drain. Refer to the exploded view [diagram](#) on page 39 for position and to "[Service Valve Drain](#)" on page 48.
- Insulate the drain line from the service valve (9) with closed cell type insulation or similar (minimum thickness 13 mm). The insulation must be weatherproof and UV resistant if exposed.
- After the collector circuit has been purged of air (refer to "[Bleeding The Solar Collectors](#)" on page 53), insulate the service valve assembly (9) from the solar tank to the drain line of the service valve with an 80 mm long x 35 mm ID piece of insulation (11) and secure with two cable ties (12).

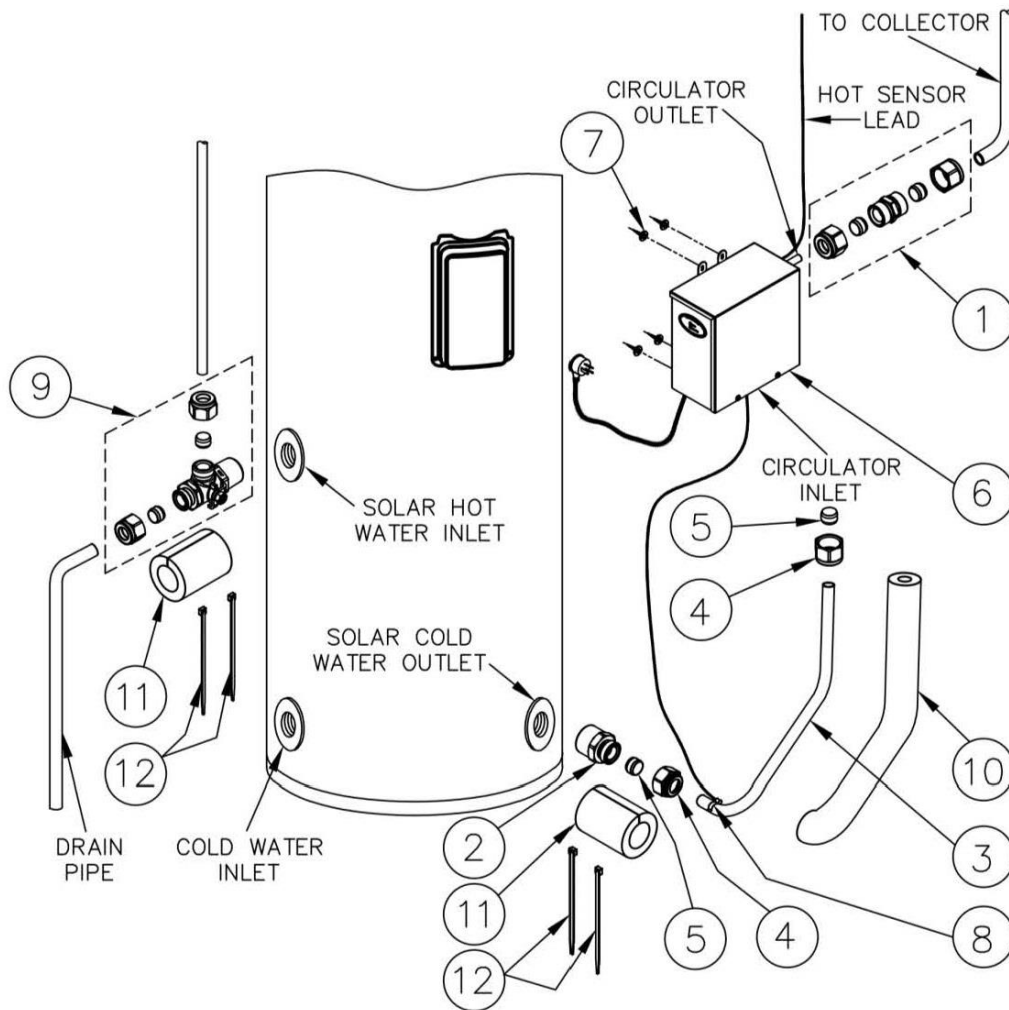

SUPPLIED IN SOLAR CONTROL UNIT KIT (299293)

- | | |
|---------------------------------------|---------------------------------------|
| 1. Fitting union male 1/2" C X 1/2" C | 7. Screws |
| 2. Union R 3/4 M x DN15 olive | 8. Cold sensor and clip |
| 3. Preformed pipe DN15 | 9. Valve service 3-way solar assembly |
| 4. Compression nut | 10. Insulation 280 mm long x 13 mm ID |
| 5. Olive | 11. Insulation 80 mm long x 35 mm ID |
| 6. Solar control unit | 12. Cable tie |

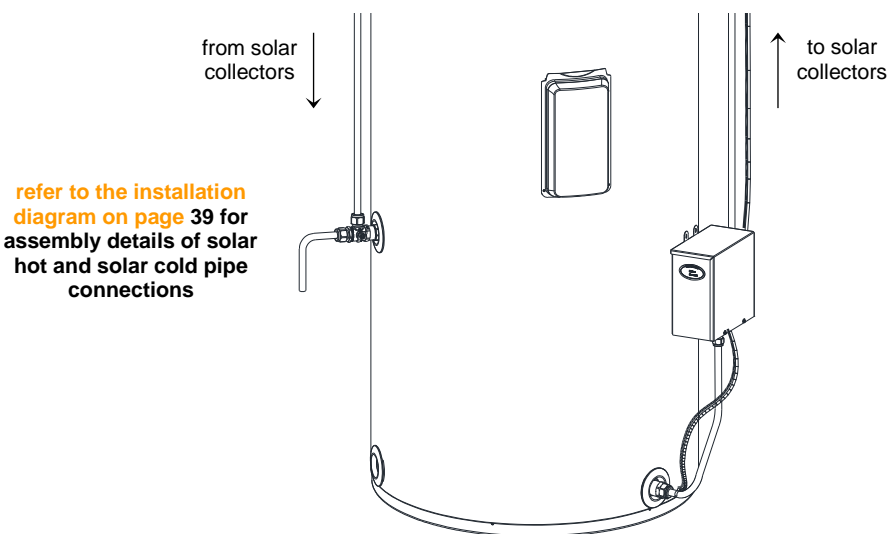

Solar Storage Tank (Single Element) with Solar Control Unit

INSTALLATION – SOLAR COLLECTORS

SOLAR COLLECTOR LOCATION

Consideration must be given to the position of the solar collectors in relation to the solar storage tank. There are limitations on the maximum length of the solar hot and solar cold pipes between the solar storage tank and the solar collectors. Refer to “Solar Water Heater Storage Tank Location” on page 30, to “Pipe Lengths” on page 42 and to “Maximum Height to Collectors” on page 43.

The solar collectors must be installed in a shade free position. The surrounds should be checked for higher buildings or trees which may cause shade at other times of the year and for small trees which may grow and shade the solar collectors in the future.

The installation must comply with the requirements of AS/NZS 3500.4 and all local codes and regulatory authority requirements. Refer to the installation instructions supplied with the collector kit for details on the installation of the solar collectors.

ROOF STRENGTH

The installer must ensure the structural integrity of the building is not compromised by the solar water heater installation and the roof structure is suitable to carry the full weight of the solar collectors and frame (if one is installed). If in any doubt of the construction or the condition of the roof, the roof should be suitably strengthened. Consult a structural engineer. Each solar collector and its fittings weigh approximately 40 kg (NPT200 – 2.0 m² collector) or 36 kg (LCS – 2.0 m² collector) or 41 kg (CSA2007 – 2.0 m² collector) when full of water.

ROOF AREA FOR INSTALLATION

Roof area required for 2.0m² solar collectors:

- | | | |
|----------------------|---------------------------|------------------------------------|
| • 4 solar collectors | – 4.5 m wide x 2.0 m deep | Weight (full) 160 kg approx. |
| • 3 solar collectors | – 3.4 m wide x 2.0 m deep | Weight (full) up to 123 kg approx. |
| • 2 solar collectors | – 2.3 m wide x 2.0 m deep | Weight (full) up to 82 kg approx. |
| • 1 solar collector | – 1.2 m wide x 2.0 m deep | Weight (full) up to 41 kg approx. |

In addition to this area, a minimum one (1) metre clearance is recommended on all four sides of the solar collectors for safe service access.

Maximum Number of Collectors

The maximum number of solar collectors for each tank size as part of an open circuit system is:

Non-Selective Surface 2.0m² Collectors – NPT200 collector

- 410 tank – 4 x collectors
- 271, 325 tanks – 3 x collectors

Selective Surface 2.0m² Collectors – LCS, CSA2007 collectors

- 410 tank – 3 x collectors
- 271, 325 tanks – 2 x collectors

ORIENTATION OF SOLAR COLLECTORS

The optimum orientation of solar collectors, to maximise system performance, is facing true north (in the southern hemisphere) or true south (in the northern hemisphere).

However, the optimum orientation of solar collectors is not always practical or achievable. If it is not possible to achieve the optimum orientation, then it is recommended to install the solar collectors as close to the optimum orientation as possible.

The total solar radiation received by solar collectors will reduce by approximately 4% to 5% when facing 45° from the optimum orientation and approximately 10% to 15% when facing 90° from the optimum orientation.

NPT200 or LCS or CSA2007 solar collectors may be installed up to 90° from the optimum orientation when installed as part of this system, however solar system performance will be reduced. Where the orientation is greater than 60° from the optimum, it may be possible for an additional solar collector to be installed or to install selective surface collectors in lieu of non-selective surface collectors to make up for the reduction in solar performance.

Each of these options should be discussed with the system owner. If neither of these options is possible nor acceptable to the system owner, then the system owner needs to be made aware of, understand and accept that solar system performance will be reduced and increased boosting may be required to meet their hot water requirements.

Where the collectors can be installed at a similar angle either east or west of the optimal orientation, then the hot water load and usage pattern may need to be considered. If the majority of hot water usage is before 2:00 PM favour an easterly bias. If the majority of hot water usage is after 2:00 PM favour a westerly bias.

Note: Always check for true north or true south using a compass or other suitable device.

Refer to “Solar Collectors” on page 27 for additional information on the selection of type of solar collectors for this system.

INCLINATION OF SOLAR COLLECTORS

To help maximise system performance, solar collectors should be installed with an optimum inclination. This is equal to 90% to 100% of the local latitude angle when collectors are oriented within 60° of true north or true south, and between 10° and 20° when the collectors are oriented between 60° and 90° from the optimum orientation.

Generally, improved summer performance is obtained from an angle of inclination less than the optimum angle and improved winter performance is obtained by an angle of inclination greater than the optimum angle. If the angle of inclination varies by 20° from the optimum angle, the solar collectors will receive about 10% less total annual solar radiation. The [latitude of some Australian cities](#) are listed on page 42.

AS/NZS 3500.4 states that solar collectors shall be installed at an angle within 20° of the local latitude angle.

However, the optimum inclination of solar collectors is not always practical or achievable. Solar collectors may be installed at the roof angle for simplicity of installation and appearance, but must never be flat for a pumped solar water heater installation. Although the solar collectors can be installed with an inclination of less than 10°, this is not advised.

The risks include:

- the collector glass not 'self-cleaning', leading to dirty collector glass reducing solar performance, and
- condensation on the underside of the glass taking longer to clear, and
- condensation droplets falling onto the absorber plate potentially causing discolouration.

The collector kit is suitable for installations with an inclination of up to 45°. Where the solar collectors are installed at inclinations greater than 45°, a With Pitch frame is necessary. Contact Rheem or your local Rheem Solar Water Heater Distributor for details.

A Variable Pitch frame can be installed to increase the angle of inclination of the collectors used in a pumped solar water heater installation. This type of frame should be used if the roof pitch either varies by more than 20° from the optimum angle or is less than 10°.

The use of a Variable Pitch frame should be discussed with the system owner. If this option is neither possible nor acceptable to the system owner, it may be possible for an additional solar collector to be installed or to install selective surface collectors in lieu of non-selective surface collectors to help make up for the reduction in solar performance compared to the optimum inclination. Each option should be discussed with the system owner.

If these options are neither possible nor acceptable to the system owner, then the system owner needs to be made aware of, understand and accept that solar system performance will be reduced and increased boosting may be required to meet their hot water requirements.

CYCLONIC OR HIGH WIND AREAS

For an installation of solar collectors on a roof in a cyclonic or high wind area, a suitable frame is required. Contact Rheem or your local Rheem Solar Water Heater Distributor for details.

LATITUDE OF SOME AUSTRALIAN CITIES

Adelaide	35°S	Cairns	17°S	Hobart	42°S	Port Hedland	20°S
Alice Springs	24°S	Canberra	35°S	Mildura	34°S	Rockhampton	24°S
Brisbane	27°S	Darwin	12°S	Melbourne	38°S	Sydney	34°S
Broken Hill	31°S	Geraldton	28°S	Perth	32°S	Townsville	19°S

PIPE LENGTHS

The solar hot and solar cold pipes between the solar storage tank and the solar collectors shall:

- be of bendable grade or hard drawn copper tube, or annealed copper tube.

Annealed copper tubing shall not be joined using olive compression fittings.

Note: When annealed copper pipe is used in the collector circuit, then a suitable length of bendable grade or hard drawn copper pipe is to be brazed to the end of the collector circuit pipe work at the connection points where a copper or brass olive and compression nut is used. This requirement is to ensure there is minimum risk of pipe movement where the copper or brass olive and compression nut seal the connection at the fitting, so leaks will not occur.

- have a continuous fall from the solar collectors to the solar storage tank. Horizontal runs of pipe work are acceptable and may be installed as part of an open circuit system.

Care must be taken to ensure the pipe work maintains a continuous fall or horizontal runs over the life of the installation. Pipe work should be fixed at regular intervals to assist in maintaining this requirement. Particular care is to be taken when annealed copper tube is used to ensure this requirement is met.

- not exceed the maximum recommended combined lengths as specified in the table.

Maximum recommended total combined pipe length (solar hot + solar cold) and number of 90° bends						
Pipe Size	1 or 2 Collectors		3 Collectors		4 Collectors	
	Pipe Length	90° Bends	Pipe Length	90° Bends	Pipe Length	90° Bends
DN15	40 metres	20	30 metres	20	15 metres	20
DN20	NR	NR	40 metres	20	40 metres	20

For each additional 90° bend, reduce the maximum total pipe length by 0.5 metres.

For each additional metre of pipe length, reduce the number of 90° bends by two.

Note: One 90° elbow is equal to two 90° bends.

NR – not recommended.

It is essential for these requirements to be followed for the system to operate correctly and efficiently. Solar pipe work which is oversized, or is too long, or does not have a continuous fall can result in a reduction in performance or the system not operating effectively.

Notes

- It is important to connect the solar hot and solar cold pipes to the correct connections at the solar collector and at the solar storage tank.
- The solar cold pipe connects to the bottom of the solar collector array and may connect to either the left or right hand side. The solar hot pipe must connect to the top of the solar collector array diagonally opposite to the solar cold pipe connection. The solar hot outlet and hot sensor connection is to be the highest point of the system.
- The hot sensor connection is at the solar hot outlet where the solar hot pipe connects to the solar collector for this open circuit system.
- Refer to “Warning: Plumber – Be Aware” on page 44.

Maximum Height to Collectors

The maximum height of an open circuit solar Loline installation, from the solar controller (circulator) to the top of the solar collectors, is determined by the maximum recommended total pipe length for the system and the water supply pressure. Refer to “Pipe Lengths” on page 42.

The maximum recommended total pipe length of the collector circuit should not be exceeded and a minimum water supply pressure of 200 kPa should be available at the inlet to the system, otherwise the system performance may be reduced or the collector circuit may not be purged of air during the commissioning of the system.

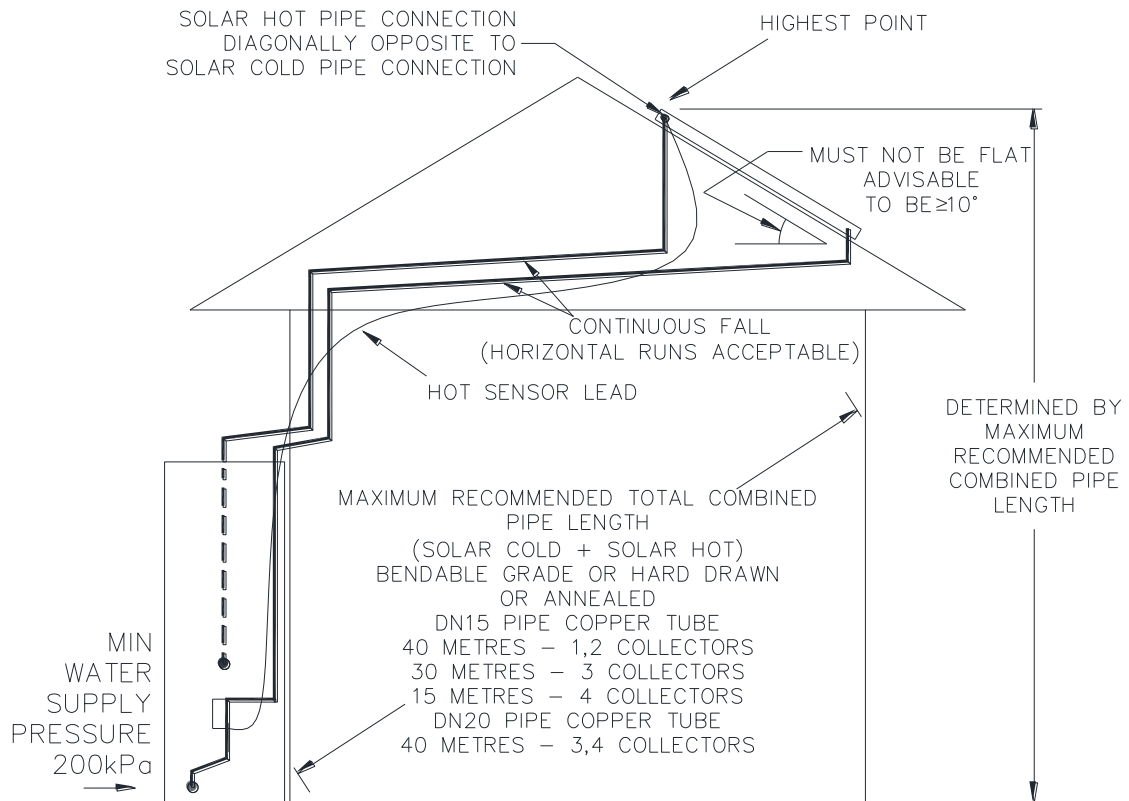

NOTES:

- PIPE WORK MUST HAVE A CONTINUOUS FALL FROM THE SOLAR COLLECTORS TO THE SOLAR STORAGE TANK. HORIZONTAL PIPE RUNS ARE ACCEPTABLE, AND MAY BE INSTALLED.
- PIPE WORK MUST BE OF BENDABLE GRADE OR HARD DRAWN COPPER TUBE, OR ANNEALED COPPER TUBE (CONDITIONS APPLY – REFER TO INSTALLATION INSTRUCTIONS).
- MINIMUM WATER SUPPLY PRESSURE TO INSTALLATION MUST BE 200kPa.
- INSTALL HOT SENSOR LEAD WITH INSULATED SOLAR PIPES DURING CONSTRUCTION FOR NEW HOMES.
- PRESSURE TESTING OF SOLAR COLLECTORS AND SOLAR CIRCUIT MUST NOT EXCEED 1000KPa.

Open Circuit System – Pipe Work Installation Requirements



WARNING: Plumber – Be Aware

- The solar hot and solar cold pipes between the solar storage tank and the solar collectors **MUST BE** of copper. All compression fittings must use brass or copper olives.
- The full length of the solar hot and solar cold pipes **MUST BE** insulated.

The insulation must:

- be of a closed cell type or equivalent, suitable for a solar water heating application and capable of withstanding the temperature of the water generated by the solar collectors under stagnation conditions

The specification of the chosen insulation material should be checked with the insulation manufacturer prior to installation as different materials may vary in temperature tolerance.

- be at least 13 mm thick
- be weatherproof and UV resistant if exposed
- extend through any penetrations in the eaves, ceiling and roof
- cover valves and fittings in the solar pipe work
- be fitted up to and cover the connections on both the solar storage tank and the solar collectors.

Note: Failure to observe these requirements also increases the risk of freeze damage.

Uninsulated pipe work, including concealed in cavities and roof spaces or where it may be in contact with a metal roof, may lead to freeze damage. There is NO WARRANTY for freeze damage if the solar hot and solar cold pipes are not insulated in accordance with the installation instructions.

The insulation is essential to assist in providing freeze protection, will offer protection to a metal roof against corrosion due to water running off the copper pipes, assist in avoiding accidental contact with the solar pipe work as very high temperature water can flow from the solar collectors to the solar storage tank, and also reduce pipe heat losses.

- The insulated copper pipe work:
 - should be fixed at suitable locations to prevent or reduce the possibility of noise from water hammer and vibration from occurring
 - is not to be placed or installed in contact with plastic pipe work.

Likewise, plastic pipe work is not to be placed or installed in contact with the insulated copper pipe work after the collector circuit is installed.

- Plastic pipe **MUST NOT** be used, as it will not withstand the temperature and pressure of the water generated by the solar collectors under stagnation conditions. Extremely high water temperatures of up to 150°C for non-selective surface collectors and greater than 200°C for selective surface collectors and high water pressures exceeding 1000 kPa can be generated under these conditions. Plastic pipe cannot withstand these temperatures and pressures and **MUST NOT** be used. Failure of plastic pipe can lead to the release of high temperature water and cause severe water damage and flooding.
- The solar hot outlet and hot sensor connection is to be the highest point of the system. The highest point of the solar hot and solar cold pipes must be where they connect to the solar collectors, to avoid the possibility of air locks occurring in the system. There **MUST BE a continuous fall** in the pipe work from the solar collectors to the solar storage tank. Horizontal runs of pipe work are acceptable and may be installed as part of an open circuit system.
- A non-return valve **MUST BE** installed on the cold water line to the solar storage tank **AFTER** the cold water branch to a temperature limiting device.
- The pressure applied to the collector circuit and solar collectors during a pressure test of an open circuit system **MUST NOT** exceed 1000 kPa, otherwise damage may result. Refer to “Pressure Testing” on page 45.

Pressure Testing

The solar water heater, including the collector circuit, is to be isolated during the testing and commissioning of the heated water reticulation system in a building in accordance with Clause 9.3 (a) of AS/NZS 3500.4:2018. The collector circuit includes the solar hot and solar cold pipes and solar collectors.

It may be necessary to pressure test the collector circuit to comply with codes and regulatory authority requirements or on other occasions where the solar collectors and solar hot and solar cold pipes are installed prior to the solar storage tank, such as on a building site.

Note: If the collector circuit is pressure tested prior to the installation of and connection to the solar storage tank, drain the solar collectors and collector circuit completely after the pressure test. Use an air compressor to drive all of the water out and if necessary, cap the ends loosely to prevent vermin ingress and allow air pressure build up to escape.

Collector Circuit

⚠ Warning: The pressure applied to the collector circuit during a pressure test of an open circuit system **MUST NOT** exceed 1000 kPa where NPT200, LCS or CSA2007 solar collectors are installed, otherwise damage may result.

Open Circuit System

If the solar collectors, solar pipe work and solar storage tank are installed and commissioned together, then the flooding of the collector circuit with water under mains pressure for an open circuit system and checking the pipe work for leaks during the commissioning procedure can be substituted for the pressure testing of the collector circuit.

CONNECTIONS – PLUMBING

All plumbing work must be carried out by a qualified person and in accordance with the requirements of AS/NZS 3500.4 and all local codes and regulatory authority requirements.

⚠ Warning: Certain types of plastic pipe, such as polybutylene pipe, are not suitable to be used as a hot water pipe between:

- this water heater and a temperature limiting device, and
- this water heater and a hot water outlet if a temperature limiting device is not installed.

This water heater can produce water at a temperature and pressure which can exceed the performance limits of these types of pipe. This may result in pipe failure leading to severe water damage to the property. If one of these types of plastic pipe is used as a hot water pipe in the property, then a temperature limiting device must be installed between the water heater and this pipe work.

Note: The solar storage tank of a solar water heater should not be installed as part of a circulated hot water flow and return system in a building. The benefits of solar gain will be significantly reduced. If a circulated flow and return system is required, refer to “[Circulated Hot Water Flow and Return System](#)” on page 32.

CONNECTION SIZES

- Hot water connection: Rp 3/4
- Cold water connection: Rp 3/4
- Solar hot (from collector) connection:
DN15 compression fitting to Service valve – (solar hot inlet to tank: Rp 3/4)
- Solar cold (to collector) connection:
DN15 compression fitting to pipe at circulator outlet – (solar cold outlet from tank: Rp 3/4)
- Relief valve connection: Rp 1/2
- Service valve drain connection: DN15 compression fitting

WATER INLET AND OUTLET

All pipe work must be cleared of foreign matter before connection and purged before attempting to operate the water heater. All olive compression fittings must use brass or copper olives. Use an approved thread sealant such as Teflon tape on all sealing threads. Conetite or O-ring fittings do not require a thread sealant.

An isolation valve and non-return valve must be installed on the cold water line to the water heater. An acceptable arrangement is shown in the [diagram](#) on page 46. Refer also to “[Hot Water Delivery](#)” on page 31 and to “[Mains Water Supply](#)” on page 30. The plumbing arrangements for the [solar hot and solar cold pipes](#) are shown on page 39.

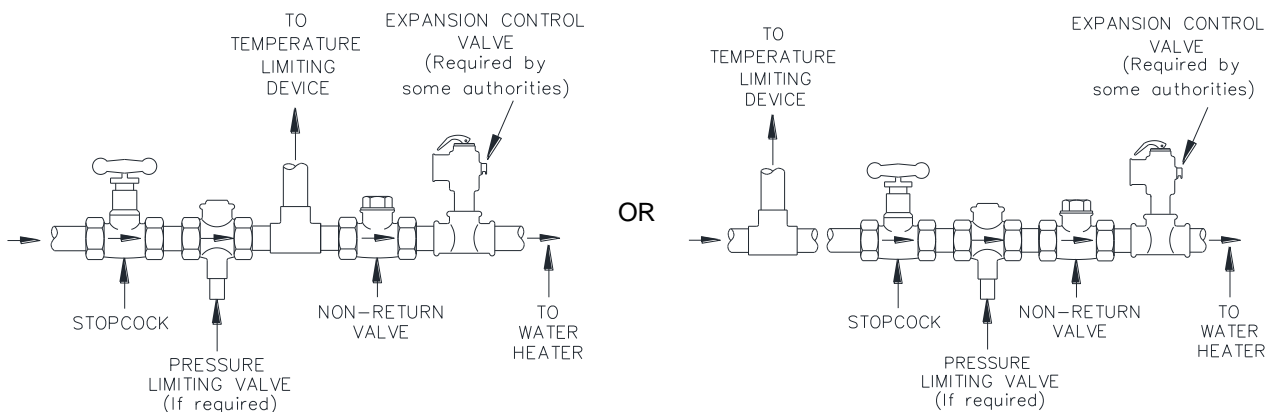

A disconnection union must always be provided at the cold water inlet and hot water outlet on the solar storage tank to allow for disconnection of the solar storage tank.

This solar storage tank has either a plastic dip tube or fitting liner in the inlet and outlet fittings (see diagram). These must be in place for the water heater to function properly. Do not remove or damage them by using heat nearby. They will be pushed into the correct position as the fitting is screwed in.

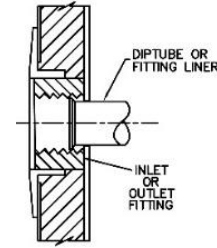

This water heater is intended to be permanently connected to the water mains and not connected by a hose-set. A braided flexible hose or semi-flexible connector may be used for connection to the water heater, where permitted by AS/NZS 3500.4.

PIPE SIZES

To achieve true mains pressure operation, the cold water line to the water heater should be the same size or bigger than the hot water line from the water heater.

The pipe sizing for hot water supply systems should be carried out by persons competent to do so, choosing the most suitable pipe size for each individual application. Reference to the technical specifications of the water heater and local regulatory authority requirements must be made.

IN-SERIES BOOSTER (IF INSTALLED)

The pipe work between the solar storage tank and an in-series booster has a minimum recommended pipe size of DN20, **MUST BE** of copper and be fully insulated with a closed cell type insulation or equivalent and in accordance with the requirements of AS/NZS 3500.4. The insulation must be weatherproof and UV resistant if exposed. The insulation must be fitted up to the connections on both the solar storage tank and the in-series booster.

An isolation valve may be installed on the water line to the in-series booster. The isolation valve must be of a full flow type if the in-series booster is a continuous flow water heater.

TEMPERATURE PRESSURE RELIEF VALVE

The temperature pressure relief valve is shipped either under the top flap of the water heater carton or behind the front cover. The temperature pressure relief valve must be fitted before the water heater is operated. Before fitting the relief valve, make sure the probe has not been bent.

To fit the relief valve:

- Seal the thread with an approved thread sealant such as Teflon tape - never hemp. Make sure tape does not hang over the end of the thread.
- Hand tighten the valve into the opening marked "Relief Valve" (refer to the [installation diagram](#) on page 36).
- Using a spanner engaged on the valve's spanner flats and applying medium pressure to tighten, turn the relief valve an additional ½ to 1 ½ turns to secure and make the joint water tight, leaving the valve drain pointing downwards.

⚠ Warning: Do not use a pipe wrench or poor fitting tool on the valve body nor over tighten the valve, as this could damage the valve and prevent safe operation.

- Operate the easing lever on the valve to check the smooth operation of the valve plunger. It is very important the lever is raised and lowered gently. The lever should move smoothly and without undue force.
- If the lever cannot be moved or is jerky in its movement, then the valve has been damaged and must be replaced.
- A copper drain line must be fitted to the temperature pressure relief valve (refer to ["Relief Valve Drain"](#) on page 48).
- The valve must be insulated with closed cell polymer insulation or similar (minimum thickness 9 mm) and the insulation installed so as not to impede the operation of the valve.

The insulation must be weatherproof and UV resistant if exposed.

EXPANSION CONTROL VALVE

Local regulations may make it mandatory to install an expansion control valve (ECV) in the cold water line to the water heater. In other areas, an ECV is required if the saturation index is greater than +0.4 (refer to “Water Supplies” on page 20).

The expansion control valve must always be installed after the non-return valve and be the last valve installed prior to the water heater (refer to diagrams on page 46). A copper drain line must be fitted to the expansion control valve (refer to “Relief Valve Drain” on page 48).

The valve, if installed within 500 mm of the water heater, must be insulated with closed cell polymer insulation or similar (minimum thickness 9 mm) and the insulation installed so as not to impede the operation of the valve. The insulation must be weatherproof and UV resistant if exposed.

RELIEF VALVE DRAIN

DN15 copper drain lines must be fitted to the temperature pressure relief valve and expansion control valve (if one is installed). Connect the drain lines to the valves using disconnection unions. The drain line from the valve to the point of discharge should be as short as possible, have a continuous fall all the way from the water heater to the discharge outlet and have no tap, valves or other restrictions in the pipe work.

A drain line from a relief valve must comply with the requirements of AS/NZS 3500.4.

A drain line must be no longer than nine (9) metres with no more than three bends greater than 45° before discharging at an outlet or air break. The maximum length of nine (9) metres for a drain line is reduced by one (1) metre for each additional bend required of greater than 45°, up to a maximum of three additional bends. Where the distance to the point of final discharge exceeds this length, the drain line can discharge into a tundish.

Subject to local regulatory authority approval, the drain lines from the temperature pressure relief valve and expansion control valve from an individual water heater may be interconnected.

The outlet of a drain line must be in such a position that flow out of the pipe can be easily seen, but arranged so discharge will not cause injury, damage or nuisance. The termination point of a drain line must comply with the requirements of AS/NZS 3500.4. Drain lines must not discharge into a safe tray.

In locations where water pipes are prone to freezing, drain lines must be insulated, must not exceed 300 mm in length and are to discharge into a tundish through an air gap of between 75 mm and 150 mm.

If a drain line discharges into a tundish, the drain line from the tundish must be not less than DN20. The drain line from a tundish must meet the same requirements as for a drain line from a relief valve.

⚠ Warning: As the function of the temperature pressure relief valve on this water heater is to discharge high temperature water under certain conditions, it is strongly recommended the pipe work downstream of the relief valve be capable of carrying water exceeding 93°C. Failure to observe this precaution may result in damage to pipe work and property.

SERVICE VALVE DRAIN

A copper drain line must be fitted to the service valve drain outlet using the compression nut and olive provided with the valve. The drain line must carry the discharge safely to drain, clear of the water heater and solar control unit. The pipe work from the service valve to the drain should be as short as possible and fall all the way from the valve with no restrictions. Use DN15 pipe.

The outlet of the drain line must be in such a position that flow out of the pipe can be easily seen – but arranged so water discharge will not cause splashing, nuisance, damage or injury. Water discharged from the outlet of the drain line can be of a high temperature and under certain conditions, boiling or steaming.

⚠ Warning: The solar collectors can generate very high temperature water and even steam can be generated under certain conditions when the service valve is opened.

It is recommended the drain line be fully insulated with closed cell polymer insulation or similar (minimum thickness 13 mm). The insulation must be weatherproof and UV resistant if exposed. It is also recommended pipe work downstream of the service valve be capable of carrying boiling water. Failure to observe this precaution may result in damage to pipe work and property.

CONNECTIONS – ELECTRICAL

The power supply to the water heater must not be switched on until the water heater is filled with water and a satisfactory megger reading is obtained.

All electrical work and permanent wiring must be carried out by a qualified person and in accordance with the edition of the Wiring Rules AS/NZS 3000 in force in the state or territory at the time of installation, and all local codes and regulatory authority requirements.

If this water heater is installed with an in-series booster, then the electric booster heating unit will not need to be connected to a power supply and the references to the electric booster heating unit, thermostat and boosting controls in these installation instructions will not be applicable to the installation.

Note: AS 3498 requires that a water heater provides the means to inhibit the growth of Legionella bacteria in potable water. This water heater can satisfy this AS 3498 requirement provided, where an in-series booster water heater is not installed, the electric booster is energised for a sufficient period each day and the electric booster thermostat setting is 60°C or higher.

The power consumption of the water heater is:

Component	Power consumption	Comments
Solar controls	4 Watts	Constant load - differential controller
Solar circulator	36 Watts	Maximum load at solar heating cycle start up
	30 Watts	Average load during the solar heating cycle
Booster heating unit	3600 Watts	Load when booster heating unit is operating

The water heater will only operate on a sine wave at 50 Hz. Devices generating a square wave cannot be used to supply power to the water heater.

SOLAR STORAGE TANK

The solar storage tank with an electric booster heating unit must be directly connected to a 220 V - 240 V a.c. 50 Hz mains power supply with an isolating switch installed at the switchboard. The Wiring Rules AS/NZS 3000:2018 requires a second and lockable isolating switch be installed adjacent to but not on or attached to the solar storage tank, and a residual current device (RCD) installed in the electrical circuit to the water heater.

The booster heating unit and the terminal block for the electrical connection is behind the front cover located at the midpoint of the tank. A flexible 20 mm conduit is required for the electrical cable to the solar storage tank. The conduit is to be connected to the unit with a 20 mm terminator. Connect the power supply wires directly to the terminal block and earth tab connection, ensuring there are no excess wire loops inside the front cover. The temperature rating of the power supply wires insulation must suit this application, or the wiring protected by insulating sleeving with an appropriate temperature rating if it can make contact with the internal storage cylinder. The temperature of the internal storage cylinder can reach 75°C under normal operation.

The water heater is more suited for the booster heating unit to be connected to either a continuous, or a time of use, or an extended Off-Peak (overnight and day) electricity supply. A timer can also be used to control the boosting periods and help maximise solar savings. Refer to **"Booster Control"** on page 51.

The booster heating unit may be connected to an Off-Peak (overnight) electricity supply, however this will only allow the booster to heat the water overnight. If this type of connection is considered, care must be taken to ensure there is sufficient boost capacity to meet the household's full day and night's hot water supply during periods of no or low solar gain, particularly in cold weather.

Discuss the power supply and hot water usage requirements with the householder.

The solar control unit is supplied with a power cord to be plugged into a general purpose outlet (GPO). Refer to **"Solar Control Unit"** on page 50.

THERMOSTAT SETTING

The thermostat controlling the electricity supply to the booster heating unit is adjustable from 60°C to 70°C. The factory setting of the thermostat is 60°C. The thermostat is adjusted by turning the adjuster anticlockwise to decrease the temperature setting and clockwise to increase the temperature setting. Only adjust the temperature setting when the isolating switch is switched off at the switchboard.

For reasons of safety and economy, we advise the thermostat be set at the lowest temperature that will provide sufficient hot water during periods when boosting is required. It is recommended the thermostat is set at 60°C to maximise solar contribution. Discuss the thermostat setting requirements with the householder.

SOLAR CONTROL UNIT

The solar control unit, supplied with a 1.8 metre power cord, requires a switched 220 V - 240 V a.c. 50 Hz general purpose outlet (GPO) to be located within 1.2 metres of the installation. The GPO must have a continuous power supply originating from a circuit other than the water heater circuit. The GPO is required to be weatherproof if installed outdoors.

The GPO to the solar control unit must be switched on for the solar control system to operate and solar gain to be achieved. This includes for the circulating freeze protection function to operate.

The solar control unit automatically controls the flow rate through the collector circuit. This is achieved via the hot and cold sensors and differential controller programming providing control over the operation of the circulator. There is no provision for nor is adjustment to the solar control unit required.

WIRING DIAGRAM – SOLAR STORAGE TANK

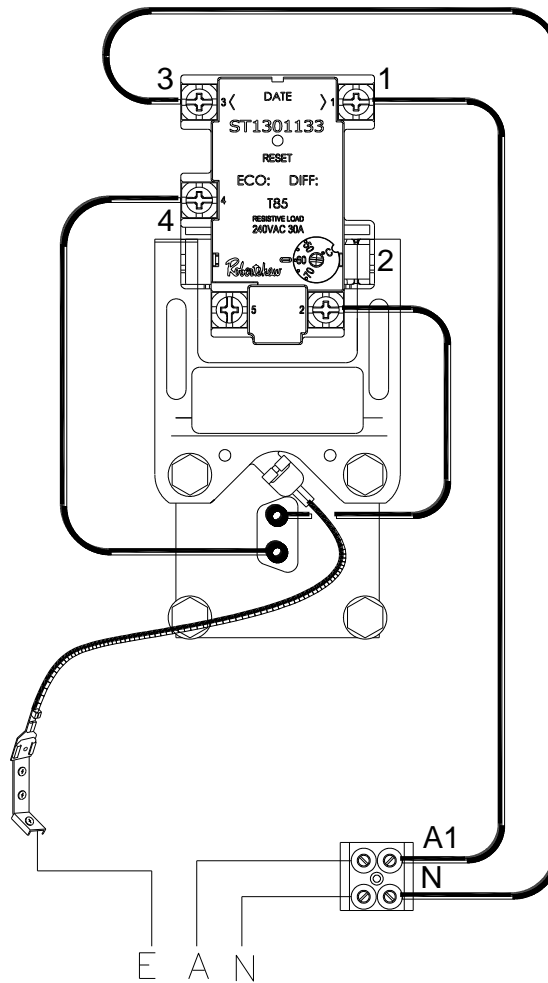

Booster Heating Unit – Single Element Model

BOOSTER CONTROL

The isolating switch(s) installed at the switchboard and adjacent to the solar storage tank (if installed) should be left switched on.

Leaving the isolating switch(s) switched on will also provide a sufficient period of time each day for the booster heating unit to operate, if required, to satisfy the requirements of AS 3498.

Timer Control Switch

A suitably rated timer control switch can be installed and will help maximise energy savings with an electrically boosted solar water heater connected to a **continuous, time of use or extended Off-Peak (overnight and day)** electricity supply.

If used with an extended Off-Peak (overnight and day) electricity supply, the timer switch should:

- be operated by a continuous power supply on its own circuit from the switchboard with the booster heating unit operated by the Off-Peak power supply.

A double pole isolating switch is required to be installed at the switchboard to simultaneously isolate both circuits.

or

- be of a type which has an internal rechargeable battery to keep time when the power supply is not available to the timer.

Refer to “Booster Control” on page 14 for information on programming the timer.

WIRING DIAGRAM – TIMER CONTROL SWITCH

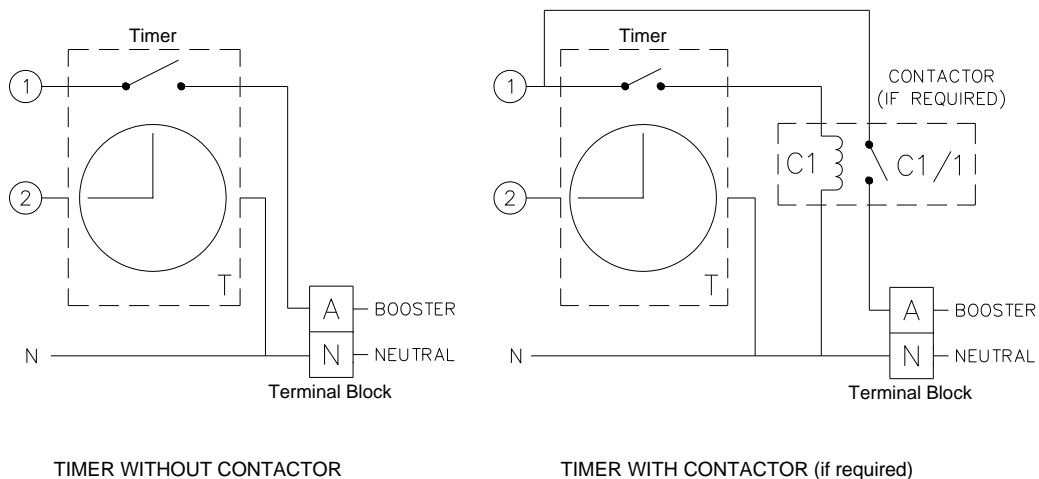
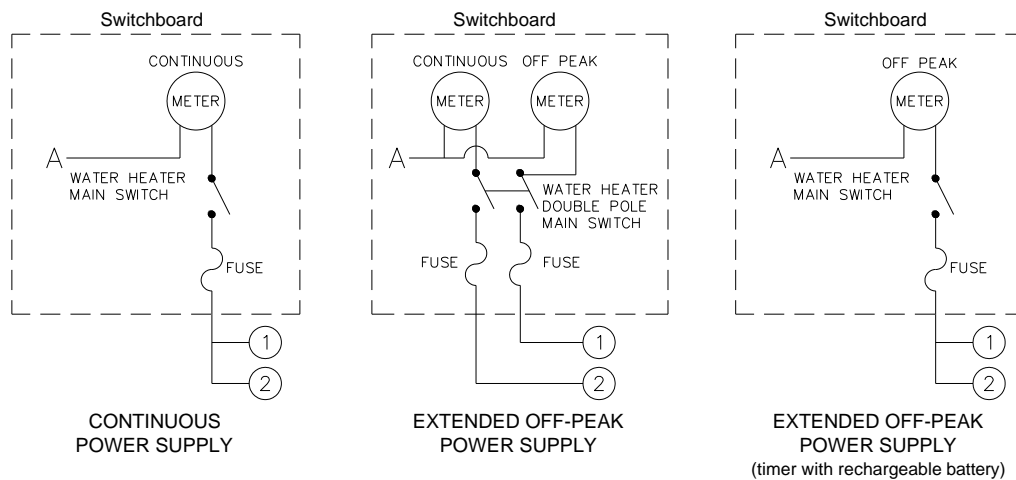

COMMISSIONING

TO FILL AND TURN ON THE WATER HEATER

The power supply to the solar storage tank and solar control unit must not be switched on until the water heater is filled with water and a satisfactory megger reading is obtained.

- Open all of the hot water taps in the house (don't forget the shower).
- Open the service valve fitted at the solar hot water inlet (from collector) of the solar storage tank, using a pair of pliers or other appropriate tool. Refer to the [Service 3-Way Valve diagram](#) on page 53.
- Open the cold water isolation valve fully on the cold water line to the water heater.

Air will be forced out of the taps and the service valve drain line.

- Close each tap as water flows freely from it.
- Close the service valve when water runs freely from its drain line.

The solar collectors and collector circuit should now be purged of air.

- Check the pipe work for leaks.
- Inspect for leaks at the temperature pressure relief valve connection to the water heater.

If a leak is detected, close the cold water isolation valve fully and relieve pressure from the water heater by either operating the easing lever on the temperature pressure relief valve or opening a hot tap. Remove the valve and all of its thread sealant from the threads of the valve. Reapply new thread sealant and refit the valve. Refer to the procedure in ["Temperature Pressure Relief Valve"](#) on page 47.

- Operate the easing lever on the temperature pressure relief valve to check the smooth operation of the valve plunger and that water discharges freely from the drain line. It is very important the lever is raised and lowered gently. The lever should move smoothly and without undue force.

If the lever cannot be moved or is jerky in its movement, then the valve has been damaged and must be replaced.

- Plug in the solar control unit at the power outlet and switch on the electrical supply.

The power outlet must be switched on for the solar control unit to operate and solar gain to be achieved and for the circulating freeze protection to be available.

Refer to ["Solar Controller Operation at Start-Up"](#) on page 54.

Note: The solar control unit automatically controls the flow rate through the collector circuit. This is achieved via the hot and cold sensors and differential controller programming providing control over the operation of the circulator. There is no provision for nor is adjustment to the solar control unit required.

- Switch on the electrical supply at the water heater isolating switch on the switchboard and at the isolating switch at the solar storage tank (if installed).

- Set the timer if one is installed.

Refer to ["Booster Control"](#) on page 51.

- Remove the packaging / covers from the solar collectors.

Note: If the service 3-way valve was not opened during the tank filling procedure above, then the collector circuit will need to be purged of air. Refer to ["Bleeding the Solar Collectors"](#) on page 53.

Explain to the householder or a responsible officer the functions and operation of the solar water heater and the timer if one is installed. Upon completion of the installation and commissioning of the water heater, leave this guide with the householder or a responsible officer.

TO TURN OFF THE WATER HEATER

If it is necessary to turn off the water heater on completion of the installation, such as on a building site or where the premises is vacant, then:

- Switch off the electrical supply at the water heater isolating switch on the switchboard and at the isolating switch at the solar storage tank (if installed).
- Switch off the electrical supply to the solar control unit at the power outlet (refer to note below).
- Close the cold water isolation valve at the inlet to the water heater.

Notes

- The freeze protection system will be rendered inoperable if electrical power is not available at the solar control unit. Damage caused by freezing due to no power at the solar control unit is not covered by the Rheem warranty.
- If there is a risk of freezing, then it is necessary to drain the solar collectors and solar hot and solar cold pipes (refer to “[Draining the Solar Collectors](#)” on page 56).
- Refer to “[Terms of the Rheem Warranty](#)” on page 4.

BLEEDING THE SOLAR COLLECTORS

Upon completion of the installation, if the service 3-way valve was not opened during the tank filling procedure, then it is necessary to purge the air from the collector circuit.

To purge air from the collector circuit:

- Ensure the water heater is full of water and all of the hot taps are turned off.
- Using a pair of pliers or other appropriate tool, open the service 3-way valve fitted at the solar hot water inlet (from collector) of the solar storage tank (see diagram).

⚠ Warning: Stand well aside of the service valve drain pipe discharge point and exercise care to avoid any splashing of water, as water or in some circumstances steam discharged from the solar collectors may be of a very high temperature.

- The mains pressure will force water to flow from the tank and through the pipe work, forcing air from the collector circuit through the service valve. This is evidenced by spurting of water from the drain line connected to the service valve.

Note: Allow water to flow from the drain line for a few minutes before closing the service valve. Water already in the solar hot pipe will drain out prior to air in the top of the collector circuit being purged by the mains pressure water rising in the solar cold pipe.

- Close the service valve when water runs freely under mains pressure from the drain line.

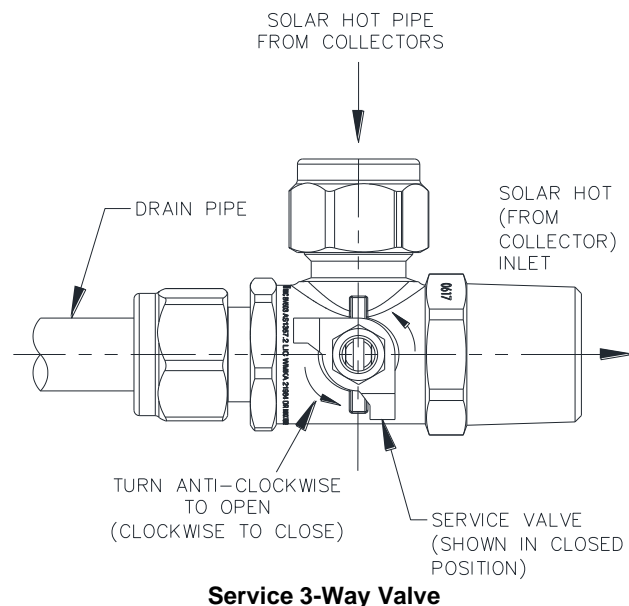

SOLAR CONTROLLER OPERATION AT START-UP

When the electrical supply is switched on to the solar control unit at start up:

- If there is no solar gain, the circulator will not activate and the green LED will emit a slow pulse.

The slow pulse indicates the circulator is not activated and the power to the solar control unit has been on for less than 48 hours.

- If there is solar gain, the circulator activates and the green LED will emit a series of three (3) flashes.

The three (3) flashes indicate the circulator is operating and power to the solar control unit has been on for less than 48 hours.

- The circulator will operate at full speed for approximately fifteen (15) seconds.

After fifteen (15) seconds, the solar controller will commence to pulse the circulator to reduce the flow rate through the collector circuit. This will increase the temperature rise across the solar collectors and assist in maximising the system efficiency for the available solar energy. It is normal operation for the circulator to experience a pulsing effect.

- The red LED may emit a rapid pulse for a short period (whilst the green LED is emitting a series of three (3) flashes), particularly if the solar collectors were left uncovered during the final stages of the installation and commissioning procedure.

This indicates a temperature difference between the hot sensor and cold sensor of greater than 45°C and does not represent a fault code. This is the result of a build-up of heat and increase in water temperature in the solar collectors prior to the switching on of the electrical supply to the solar control unit.

The rapid pulsing of the red LED will cease as the water circulates and the heat is dissipated from the solar collectors. This should be within four (4) to five (5) minutes of start-up, but may take up to ten (10) minutes.

Whilst the red LED is emitting a rapid pulse, the circulator will operate at full speed. After the red LED has extinguished, the solar controller will commence to pulse the circulator to reduce the flow rate through the collector circuit.

If the red LED does continue to emit a rapid pulse for longer than ten (10) minutes, this may indicate water is not circulating through the solar collectors and collector circuit:

- switch off the electrical supply at the power outlet to the solar control unit
- repeat the procedure to bleed the solar collectors

Refer to [“Bleeding the Solar Collectors”](#) on page 53.

- switch on the electrical supply at the power outlet to the solar control unit.

DIAGNOSTIC FEATURES OF THE SOLAR CONTROLLER

A solar monitor is located on the side of the solar control unit and houses a green and a red LED.

The green LED, marked “Solar”, indicates the current operational mode of the solar water heater and the red LED, marked “Attention”, may indicate a potential fault mode.

The green LED will emit either a constant glow, a constant pulsing or a series of flashes, with a two (2) second interval between each series.

The red LED will emit either a constant glow, a constant pulsing or a series of flashes with a two (2) second interval between each series. A constant glow or pulsing does not necessarily mean there is a fault with the system. A series of flashes indicates there may be a particular fault condition with the system.

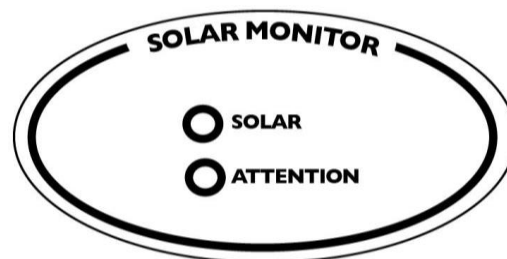

The modes are:

Flashes	Operational Modes
solid green (remains on)	Standby mode
green slow pulse	Standby mode (power on for less than 48 hours)
green rapid pulse	Circulating water through collectors
3 x green	Circulating water through collectors (power on for less than 48 hours)
no green (remains off)	Power outage or call for service

Flashes	Indicator or Fault Modes
solid red (remains on)	Hot sensor temperature greater than 130°C
red rapid pulse	Temperature rise across collector greater than 45°C (circulator at full speed)
3 x red	Hot sensor in collector – short circuit
4 x red	Hot sensor in collector – open circuit
5 x red	Cold sensor –short circuit
6 x red	Cold sensor – open circuit

If the power supply to the solar control unit is on and the green LED is off or the red LED is flashing, this indicates there may be a fault with the water heater. The red LED may emit from three (3) to six (6) flashes in each series of flashes. A constant glow or pulsing of the red LED does not necessarily mean there is a fault with the system.

Note: During periods of high solar radiation and if the circulator activates after having been off, such as during start up if the solar collectors have not been covered, it is possible the red LED may emit a rapid pulse for a period of up to ten (10) minutes. This does not indicate a fault. Refer to [“Solar Controller Operation at Start-Up”](#) on page 54 for the possible green and red LED pulsing sequence during start up procedure.

If the red LED continues to emit a rapid pulse for longer than ten (10) minutes, or emits a series of flashes, then count the number of flashes and phone Rheem Service or their nearest Accredited Service Agent to arrange for an inspection.

DRAINING THE SOLAR COLLECTORS

To drain the solar collectors and the solar hot and solar cold pipes:

- Cover the solar collectors with an opaque material.
- Open a hot water tap and allow the water to run for five minutes immediately prior to draining the solar collectors.

This will assist in the transfer of any high temperature water in the solar collectors to the solar storage tank.

- Close the hot water tap.
- Turn off the water heater (refer to [“To Turn Off The Water Heater”](#) on page 53).
- Using a pair of pliers or other appropriate tool, open the service valve fitted at the solar hot water inlet (from collector) of the solar storage tank (refer to [diagram](#) on page 53).

⚠ Warning: Exercise care, as water discharged from the solar collectors may be of a very high temperature.

- Undo the compression fitting on the union located to the right of the solar control unit, and disconnect the solar cold pipe.

Water will now drain from the solar collectors and the solar hot and solar cold pipes.

- When water stops flowing from the solar hot and solar cold pipes, reconnect the solar cold pipe to the circulator and tighten the compression fitting.
- Close the service valve.

DRAINING THE SOLAR STORAGE TANK

To drain the solar storage tank:

- Cover the solar collectors with an opaque material.
- Open a hot water tap and allow the water to run for five minutes immediately prior to draining the solar storage tank.

This will assist in the transfer of any high temperature water in the solar collectors to the solar storage tank.

- Close the hot water tap.
- Turn off the water heater (refer to [“To Turn Off The Water Heater”](#) on page 53).

⚠ Warning: Exercise care, as water discharged from the solar storage tank may be of a very high temperature.

- Operate the relief valve lever - do not let the lever snap back or you will damage the valve seat. **It is very important the lever is raised and lowered gently.**

Operating the lever will release the pressure in the water heater.

- Undo the union at the cold water inlet and attach a hose.

Let the other end of the hose go to a drain.

- Open the temperature pressure relief valve by holding the lever in the raised position.

This will let air into the solar storage tank and allow the water to drain through the hose.

PURGING AND FLUSHING THE SOLAR COLLECTORS

Upon completion of the installation, if the service 3-way valve was not opened during the tank filling procedure, then it is necessary to purge the air from the collector circuit.

Other than at the time of the water heater's installation, it will be necessary to purge air from the collector circuit:

- When the water heater is to be turned on and the solar collectors and solar hot and solar cold pipes have been drained.
- After maintenance has been conducted on the pipe work and air has entered the system.
- If the circulator appears not to be circulating water around the system.

It is also recommended to flush the solar collectors every five (5) years. This will assist in keeping the solar collectors, and solar hot and solar cold pipes clear of sediment.

It may also be necessary to flush the solar collectors if there is sediment in the water supply.

⚠ Warning: Other than at the time of the water heater's installation, it is recommended purging air from the collector circuit or flushing of the solar collectors be conducted early in the morning, within three (3) hours of sunrise, when the sun is low in the sky. The water temperature inside the solar collectors is lower as the solar collectors would not have had a chance to gain as much heat as later in the day. Purging air from the collector circuit or flushing the solar collectors at a time later than this can result in the discharge of high temperature water and in some circumstances, high temperature steam.

To purge air from the collector circuit or flush the solar collectors:

- Open a hot water tap and allow the water to run for five (5) minutes.
- Close the hot tap.
- Wait a further five (5) minutes before attempting to purge air from the collector circuit or flush the solar collectors.

This will assist in the transfer of any high temperature water in the solar collectors to the solar storage tank.

⚠ Warning: Exercise care, as water discharged from the solar collectors may be of a very high temperature.

- Follow the procedure "[Bleeding the Solar Collectors](#)" on page 53, allowing the water to flow from the service valve drain line for a few minutes before closing the service valve.

This page is intentionally blank.

This page is intentionally blank.

This page is intentionally blank.



INSTALLATION REPORT

Dear Installer / Customer

A copy of this installation report filled out in full and signed can be attached to an STC Assignment Form (where applicable) as a method to demonstrate proof of installation. It can be copied and kept for your records.

Installer, please complete all details below

Owner's Name							
Installation Address							
Suburb		Telephone Home					
State		Work					
Postcode		Mobile					
Email Address							
Installing Company / RSS / Agent		No. of Stories of Install		Single	Other		
Installer's Name		Installation Date					
Type of Installation (please circle)	Replace Complete Solar System	Replace Solar Tank	Replace Electric or Gas	Replace Heat Pump	New Building	New Install on Existing Building (not replacing a unit)	Other
System Model No		System Type					
Tank Model No		Tank Serial No					
Collector Model No		No of Collectors					
Collector Serial No's	1)	2)	3)	4)			
Electric Booster (please circle)	Electric continuous	Off Peak 1 (night)	Off Peak 2 (night & day)	Solar Preheat only			
Electric Booster Control (please circle)	None	Timer	Manual Switch	Other			
Gas Booster (if installed)	Model No		Serial No				

If replacing a water heater, please give details

Brand		Model No		Electric	Gas
If a Rheem unit	Tank Serial No		Date of manufacture		
Collector Serial No's	1)	2)	3)	4)	
Comments					
Signature:	Installer:		Customer:		
Date					

This page is intentionally blank.

This page is intentionally blank.

