

Owners Guide and Installation Instructions



Commercial Air to Water Heat Pump Water Heater



Install a Rheem



WaterMark

WMKA21549

*This water heater must be installed and serviced by a qualified person.
Please leave this guide with a responsible officer.*

**Notice to Victorian Customers from the
Victorian Plumbing Industry Commission.**

**This water heater must be installed by a licensed person as required by
the Victorian Building Act 1993.**

Only a licensed person will give you a Compliance Certificate, showing that the work complies with all the relevant standards. Only a licensed person will have insurance protecting their workmanship for 6 years. Make sure you use a licensed person to install this water heater and ask for your Compliance Certificate.

PATENTS

This water heater may be protected by one or more patents or registered designs.

© Registered trademark of Rheem Australia Pty Ltd.
™ Trademark of Rheem Australia Pty Ltd.

CONTENTS

RESPONSIBLE OFFICER – We recommend you read pages 4 to 19.
The other pages are intended for the installer but may be of interest.

Contents	3
About Your Water Heater	4
How Your Water Heater Works.....	8
Regular Care	12
Water Supplies.....	14
Save A Service Call	16
Installation.....	20
Heat Pump And Tank Assembly	38
Manifold Installations	43
Connections – Plumbing	46
Commissioning.....	65
Draining The Water Heater	80
Automatic Defrost	83
Rheem Heat Pump Water Heater Warranty - Australia & New Zealand Only -	86

ABOUT YOUR WATER HEATER

WATER HEATER APPLICATION

This water heater is designed for the purpose of heating potable water. Its use in an application other than this may shorten its life.

MODEL TYPE

Congratulations for choosing a Rheem® commercial air to water (A2W) heat pump water heater. The Rheem A2W heat pump water heater is designed for outdoor or indoor installation, model dependent.

HOW HOT SHOULD THE WATER BE?

The heat pump (compressor, evaporator and condenser) will operate until a water temperature of up to set point is reached.

To meet the requirements of the National Plumbing Standard (AS/NZS3500.4) the temperature of the stored water must not be below 60°C.

The factory setting is 61°C. The set point can be adjusted up to 65°C depending on site suitability after consulting with Rheem.

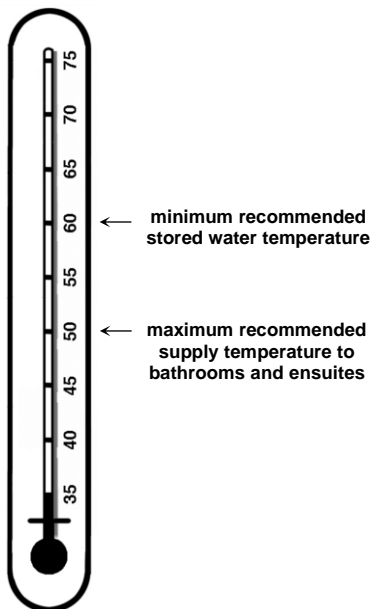

HOTTER WATER INCREASES THE RISK OF SCALD INJURY

This water heater can deliver water at temperatures which can cause scalding. Check the water temperature before use, such as when entering a shower or filling a bath or basin, to ensure it is suitable for the application and will not cause scald injury.

We recommend and it may also be required by regulations that an approved temperature limiting device be fitted into the hot water pipe work to the bathroom and ensuite when this water heater is installed. This will keep the water temperature below 50°C (55°C in NZ) at the bathroom and ensuite. The risk of scald injury will be reduced and still allow hotter water to the kitchen and laundry.

TEMPERATURE ADJUSTMENT

Set Point Quick Setting

Press '**prg**' from the main display screen and the Set Point page will appear. Cursor will be on the set temperature. Pressing the up and down keys will adjust the setting in 0.1 increments. Hold down for rapid change. Press '**Enter**'

ABOUT YOUR WATER HEATER

to confirm change. Press '**esc**' to return to the main display screen. Refer to **page 60** for more information.

WARNING

This water heater is only intended to be operated by persons who have the experience or the knowledge and the capabilities to do so. This water heater is not intended to be operated by persons with reduced physical, sensory or mental capabilities i.e. the infirm, or by children. Children should be supervised to ensure they do not interfere with the water heater.

This water heater uses 415V / 240 V AC electrical power for operation of the control systems and other electrically operated components. The removal of the access cover(s) will expose 415V / 240 V wiring. They must only be removed by a qualified person.

- Do not use **aerosols, stain removers and chemicals** near the water heater whilst it is working. Gases from some aerosol sprays, stain removers and chemicals are corrosive to the materials used in the heat pump system.
- Do not store swimming pool chemicals, household or industrial cleaners, etc., near the water heater.
- Ensure the air inlet and outlet louvres and air flow are not obstructed in any way at any time.

SAFETY

This water heater is supplied with built in Rheem IQ Controller which controls low and high pressure switches, low temperature cut off, temperature safety switch and flow switch.

Additionally, the compressor is fitted with thermal overload protection, the condenser heat exchanger is fitted with a pressure relief valve, the heat pump is supplied with a built in ambient temperature sensor and the storage tanks are supplied with a combination temperature pressure relief valve. These devices must not be tampered with or removed. The water heater must not be operated unless each of these devices is fitted and is in working order.

If the electrical supply conduit to the water heater is damaged, it must be replaced by a qualified person in order to avoid a hazard. Phone your nearest Rheem Service Department or Accredited Service Agent (or Service Centre in NZ) to arrange for an inspection.

 **Warning:** For continued safety of this water heater it must be installed, operated and maintained in accordance with the Owner's Guide and Installation Instructions.

ABOUT YOUR WATER HEATER

The Rheem warranty may not cover faults if relief valves or other safety devices are tampered with or if the installation is not in accordance with these instructions.

TO TURN OFF THE WATER HEATER

- Switch off the electrical supply at the isolating switch to the water heater.
- Close the isolation valves at the inlet and outlet of the water heater.

TO TURN ON THE WATER HEATER

- First, ensure the water is connected to storage tanks, the system is filled with water and all valves between the tanks and the water heater are open.
- Switch on the electrical supply at the isolating switch to the water heater.

Note: The water heater may not turn on immediately when it is first switched on, if it is switched on within 20 minutes to 2 hours of it having been switched off at the isolating switch, or the heat pump has just completed a heating cycle. The water heater will wait until the conditions for start-up are favourable in order to protect the compressor from damage. This may take up to 20 minutes to 2 hours.

HOW DO I KNOW IF THE WATER HEATER IS INSTALLED CORRECTLY?

This water heater must be installed in compliance with the Plumbing Code of Australia (PCA).

⚠ Warning: This water heater may deliver water at high temperature. Refer to the Plumbing Code of Australia (PCA), local requirements and these installation instructions to determine if additional delivery temperature control is required.

Installation requirements are shown on **page 20**. The water heater must be installed:

- by a qualified person, and
- in accordance with the installation instructions, and
- in compliance with Standards AS/NZS 3500.4, AS/NZS 3000 and all local codes and regulatory authority requirements.

In New Zealand, the installation must also conform with Clause G12 of the New Zealand Building Code.

ABOUT YOUR WATER HEATER

DOES THE WATER CHEMISTRY AFFECT THE WATER HEATER?

The water heater is suitable for most public water supplies, however some water chemistries may have detrimental effects on the water heater, its components and fittings. Refer to “Water Supplies” on [page 14](#). If you are not sure, have your water chemistry checked against the conditions described on [pages 14 to 15](#).

HOW LONG WILL THE WATER HEATER LAST?

Your water heater is supported by a manufacturer’s warranty (refer to [page 88](#)). There are a number of factors that will affect the length of service the water heater will provide. These include but are not limited to the water chemistry, the water pressure, temperature (inlet and outlet) and the water usage pattern.

PRECAUTIONS

Where damage to property can occur in the event of the water heater leaking, the water heater must be installed in a safe tray or be suitably banded. Construction, installation and draining of a safe tray must comply with AS/NZS 3500.4 and all local codes and regulatory authority requirements.

The water heater must be maintained in accordance with the Owner’s Guide and Installation Instructions. Refer to “Regular Care” on [page 12](#).

If this water heater is to be used where an uninterrupted hot water supply is necessary for your application, or business you should ensure that you have back up redundancy within the hot water system design. This should ensure the continuity of hot water supply in the event that this water heater were to become inoperable for any reason. We recommend you seek advice from your plumber or specifier about your needs and building back up redundancy into your hot water supply system.

ENVIRONMENT

At the end of the service life of the heat pump water heater and prior to the water heater being disposed of, a person qualified to work with refrigerants must recover the refrigerant from within the sealed system. The refrigerant must not be vented to atmosphere. Phone your nearest Rheem Service Department or Accredited Service Agent (or Service Centre in NZ) to arrange for an inspection.

HOW YOUR WATER HEATER WORKS

The Rheem commercial air to water heat pump is an instantaneous type and does not have an integral storage cylinder. The unit is designed to be installed indoors or outdoors, model dependent. The water heater's evaporator absorbs heat from the surrounding air and transfers this heat into the water. A circulator transfers the heated water to a bank of storage tanks. The heat pump produces a sound level of up to 69 dBA (measured at 3 metres) when it is operating. The principal of operation and sound level are similar to that of an air conditioner.

When hot water is drawn off and cold water enters the storage tanks, a remote thermostat activates the fan, compressor and circulating pump of the water heater. Air is drawn in through the inlet louvres on the side of the water heater and then past the evaporator, where heat is transferred from the air to a refrigerant fluid. The fluid is compressed and passes to the condenser (heat exchanger) where heat is transferred into the water. The pump circulates water from the bottom of the storage tanks through the heat exchanger and the heated water is circulated back into the storage tanks. The fan discharges the cooled air through the fan grilles on the top of the water heater. This process continues until the water in the storage tanks reaches the set temperature.

Even on cold days, heat is drawn from the surrounding air. The heat pump will operate most efficiently at temperatures between a minimum of 5°C and maximum of 45°C. The efficiency of the water heater is relative to the surrounding air temperature and the incoming water temperature.

Automatic safety controls are fitted to the water heater to provide safe and efficient operation.

AUXILIARY BOOST OPERATION

The water heater can control an auxiliary heating source if the ambient temperature falls below 5°C or if 50% or more of the water heaters are in fault mode.

OPERATION AT LOW AMBIENT TEMPERATURE

Ice may begin to form on the evaporator when the ambient air temperature falls below 7°C, and this will reduce the heat pump efficiency. In this case, the heat pump will use hot gas bypass to de-ice the evaporator coil. Should the ambient temperature continue to fall below 5°C, the heat pump will enter Low Ambient mode. The water heating system can be designed to operate in one of two scenarios when ambient temperature falls below 5°C.

HOW YOUR WATER HEATER WORKS

When auxiliary heating mode is OFF, the heat pump will use hot gas bypass to melt any ice that may form on the evaporator coil when operating at air temperatures below 5°C and there will be no auxiliary boost.

When auxiliary heating mode is ON, the heat pump will use hot gas bypass to melt any ice that may form on the evaporator coil when operating at air temperatures below 5°C and auxiliary gas or electric water heater will be activated. Auxiliary heater will remain active until the air temperature reaches 7°C.

OPERATION IN FAULT MODE

If fitted, the auxiliary booster will operate instead of the heat pump if the heat pump is in fault.

For multiple heat pump (Master/Slave) configuration, the auxiliary booster will operate instead of the heat pumps if fifty percent (50%) or more heat pumps are in fault.

The auxiliary boost will operate until the set temperature is reached. The auxiliary boost should be set to 60°C.

The auxiliary boost will remain active until the water heater fault is cleared.

 **Warning:** Rheem will not be responsible for higher utility bills due to excessive use of auxiliary boost heater. It is the customers' responsibility to monitor the system regularly for its correct operation. Rheem recommends monitoring via BMS (modules supplied separately).

MAINS PRESSURE

The water heater is designed to operate at mains pressure by connecting directly to the mains water supply. If the mains supply pressure in your area exceeds that shown on [page 22](#), a pressure limiting valve must be fitted.

THERMAL CUT OUT

The refrigeration circuit is protected by thermal sensors. These will activate a thermal cut out in the event of excessive heat in the refrigeration system.

If the thermal cut out has activated, the heat pump will not operate for a period of 20 minutes to 2 hours. The water heater will make two more attempts to start up. If the thermal cut out is tripped again after the third attempt, the system will

HOW YOUR WATER HEATER WORKS

enter lock out and the alarm contacts will close. If connected to a BMS, this will alert the user that the unit is not operating.

The lockout condition can be manually reset by switching the power to the water heater off and then on.

CONTROL FUNCTIONALITY

A timer can be set through the heat pump control panel to limit the hours of operation of the water heater (e.g. to reduce noise at night).

The operation of the heat pump can also be controlled by setting up tariff option on the control panel to manage operating costs.

Note: depending on the booster configuration there may be insufficient stored energy available for the next peak period if the system is not up to temperature.

Remember, even on cloudy and cold days your heat pump water heater will heat your stored water.

HOW YOUR WATER HEATER WORKS

SUPERIOR MONITORING

The A2W Heat Pump System is supplied with 9 sensors:

1. Tank temperature sensor
2. Building flow temperature sensor
3. Water inlet temperature sensor
4. Water outlet temperature sensor
5. Refrigerant suction side temperature (superheat)
6. Suction pressure transducer
7. Discharge pressure transducer
8. Ambient air temperature sensor
9. Evaporator coil sensor

The output of these sensors are displayed on the user friendly control panel to ensure correct system operation.

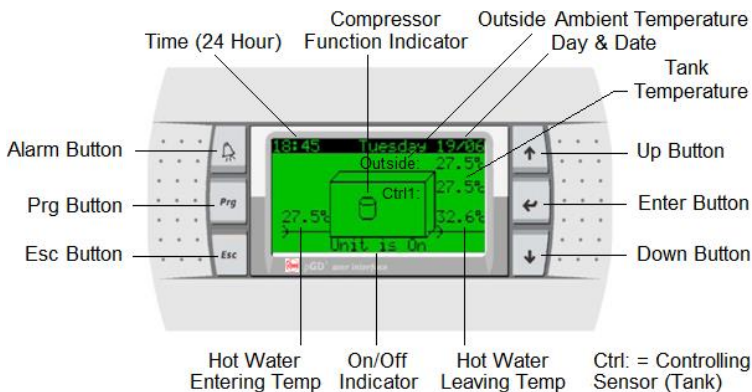

The system can be connected to BMS via interface cards (Modbus RS485 or BACnet MS-TP or BACnet TCP/IP Ethernet) supplied by Rheem. Contact Rheem for further information on BMS.

REGULAR CARE

It is suggested that the commercial heat pump be serviced annually, to retain optimum performance. Servicing must be performed by a suitably qualified person.

Annual Service

1. Check the sensors are fully installed into thermal wells.
2. Check for leaks at all fittings.
3. Check for signs of excessive corrosion on storage tank(s) jacket(s) and heat pump casing.
4. Check for sludge build up and if necessary drain and flush storage tank(s).
5. Clear hot water pump impellor and ensure free rotation.
6. Check condensate drain for blockages – clear if necessary.
7. Clean blockages and debris from evaporator fins, fan blades, grilles and louvres.
8. Isolate power to heat pump and check all electrical connections for signs of overheating due to poor connection.
9. Check for vibration or excessive noise from compressor, fans and hot water pump.
10. Check refrigerant pressures and adjust refrigerant charge if required.
11. Visually check system for any potential problems.
12. Confirm correct system operation.
13. Operate temperature and pressure relief valve and expansion control valve. Refer to **page 13**.

Five Year Service

1. As per annual service.
2. Inspect and if required, replace storage tank(s) anode(s). If the anode is not replaced, it should be replaced within three years of this service.
3. Check operation of defrost solenoid valve by manually operating the valve.
4. Replace temperature and pressure relief valve or expansion control valve.

Refer to Service manual for more information.

REGULAR CARE

TEMPERATURE AND PRESSURE RELIEF VALVE AND EXPANSION CONTROL VALVE

A temperature and pressure relief valve is supplied with the storage tanks. In many areas, including South Australia, Western Australia and scaling water areas, an expansion control valve is also fitted to the cold water line to the water heater system. The expansion control valve may discharge a small quantity of water from its drain line during the heating period instead of the temperature pressure relief valve on the storage tanks.

Operate the easing lever on the temperature and pressure relief valve and expansion control valve once every six months. **It is very important you raise and lower the lever gently.**

 **Warning:** Exercise care to avoid any splashing of water, as water discharged from the drain line will be hot. Stand clear of the drain line's point of discharge when operating the valve's lever.

If water does not flow freely from the drain line when the lever is lifted, then the water heater must be checked Phone Rheem Service or their nearest Accredited Service Agent (or Service Centre in NZ) to arrange for an inspection.

The temperature and pressure relief and expansion control valve should be replaced at intervals not exceeding 5 years, or more frequently in areas where there is a high incidence of water deposits (refer to ["Water Supplies"](#) on [page 14](#))

WATER SUPPLIES

This water heater must be installed in accordance with this advice to be covered by the Rheem warranty.

This water heater is manufactured to suit the water conditions of most public reticulated water supplies. However, there are some known water chemistries which can have detrimental effects on the water heater and its operation and / or life expectancy. If you are unsure of your water chemistry, you may be able to obtain information from your local water supply authority. This water heater should only be connected to a water supply which complies with these guidelines for the Rheem's warranty to apply.

CHANGE OF WATER SUPPLY

The changing or alternating from one water supply to another can have a detrimental effect on the operation and / or life expectation of a number of components in this water heater.

Where there is a changeover from one water supply to another, e.g. a rainwater tank supply, bore water supply, desalinated water supply, public reticulated water supply or water brought in from another supply, then water chemistry information should be sought from the supplier or it should be tested to ensure the water supply meets the requirements given in these guidelines for the Rheem warranty to apply.

SATURATION INDEX

The saturation index (SI) is used as a measure of the water's corrosive or scaling properties.

Where the saturation index is less than -1.0 , the water is very corrosive and the Rheem warranty does not apply to the water heater. In a corrosive water supply, the water can attack copper parts and cause them to fail.

Where the saturation index exceeds $+0.40$, the water is very scaling and an expansion control valve* must be fitted on the cold water line after the non-return valve. The Rheem warranty does not apply to the water heater.

Water which is scaling may be treated with a water softening device to reduce the saturation index of the water.

* Refer to the cold water connection detail on **page 46**.

CHLORIDE AND PH

Where the chloride level exceeds 250 mg/L the Rheem warranty does not apply to the water heater. In a high chloride water supply, the water can corrode stainless steel parts and cause them to fail.

WATER SUPPLIES

Where the pH is less than 6.0 the Rheem warranty does not apply to the water heater. pH is a measure of whether the water is alkaline or acid. In an acidic water supply, the water can attack stainless steel parts and cause them to fail.

Water with a pH less than 6.0 may be treated to raise the pH. The water supply from a rainwater tank in a metropolitan area is likely to be corrosive due to the dissolution of atmospheric contaminants.

SUMMARY OF WATER CHEMISTRY ADVICE AFFECTING THE RHEEM WARRANTY

The water heater is not suitable for certain water chemistries. Those chemistries are listed below. If the water heater is connected at any time to a water supply with the following water chemistry, Rheem's warranty will not cover any resultant faults:

Water Chemistry

Saturation Index (SI) < -1.0

Saturation Index (SI) > +0.4

Chloride > 250 mg/L

pH < 6.0

Component

water heater

water heater

water heater

water heater

SAVE A SERVICE CALL

Check the items below before making a service call. You will be charged for attending to any condition or fault that is not related to manufacture or failure of a part.

NOT ENOUGH HOT WATER (OR NO HOT WATER)

- **Is the electricity switched on?**

Inspect the isolating switch marked “HOT WATER” or “WATER HEATER” at the switchboard and the isolating switch at the water heater and ensure they are turned on.

Check the circuit breaker marked “HOT WATER” or “WATER HEATER” at the switchboard.

- **Is the alarm light flashing RED on heat pump controller?**

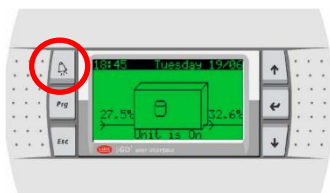

If the alarm light is flashing RED, check the alarm by pressing the alarm button. Phone your nearest Rheem Service Department or Accredited Service Agent (or Service Centre in NZ) to inform about the alarm.

- **Is the timer set?**

If the timer has been set, ensure sufficient time has been allowed to reheat the storage tanks.

- **Are you using more hot water than you think?**

Are outlets (especially the showers) using more hot water than you think? Very often it is not realised the amount of hot water used, particularly when showering. Carefully review the hot water usage. Have your plumber install a flow control valve to each shower outlet to reduce water usage.



- **Heat pump circulator has failed?**

The heat pump will not operate if the heat pump circulator has failed. Refer to “[Heat Pump Is Not Operating](#)” on [page 17](#). Phone your nearest Rheem Service Department or Accredited Service Agent to arrange for an inspection.

- **Water heater size**

Do you have the correct size water heater for your requirements? The sizing guide in the sales literature and on the Rheem website (www.rheem.com.au or www.rheem.co.nz) suggest average sizes that may be needed.

- **Air temperature is cold – defrost mode**

If this method of low ambient temperature operation is used, the heat pump will enter a defrost mode when ice is sensed on the evaporator coil. The recovery rate of the heat pump is reduced in this mode due to the lower operating air temperature and heating of water is reduced during the defrost cycle.

WATER TOO HOT

The water heater, during both normal heat pump operation and auxiliary booster operation (activated during periods of ambient temperatures below 5°C or heat pump fault), will heat the water to a temperature of 60°C to 65°C. It is recommended to set the auxiliary booster thermostat setting to 60°C.

WATER NOT HOT ENOUGH

You may find that due to heavy hot water usage the water temperature may be lower than normally expected, due to insufficient heating time being allowed. Additional storage or an in series booster may be required to be installed under these circumstances.

HEAT PUMP IS NOT OPERATING

- **Ambient temperature is cold– auxiliary boost mode**

If this method of low ambient temperature operation is used the heat pump may not operate when the ambient temperature is below 5°C and the auxiliary water heater, if installed, will operate instead. The total storage tank capacity will be heated to 60°C during these periods. Auxiliary boost will turn OFF and heat pump will start operating as normal when air temperature increases to 7°C or higher.

- **Thermal cut out activated**

Has the thermal cut out for the heat pump compressor activated?

If the thermal cut out has activated, the heat pump will not operate for a period of 20 minutes to 2 hours and display alarm on the control panel. The water heater will make two more attempts to start. If the thermal cut out is tripped again after the third attempt, the system will enter lock out. If connected to a BMS, this will alert the user that the unit is not operating.

To check whether there may be a problem, switch the power to the water heater off and on again at the circuit breaker to the water heater, then open a hot tap and allow to run for ten to fifteen minutes. The heat pump, if working properly, will activate and continue operating to heat the water. Close the hot tap when the heat pump begins to operate.

However, if the heat pump deactivates within five minutes, there may be a problem. Phone your nearest Rheem Service Department or Accredited Service Agent (or Service Centre in NZ) to arrange for an inspection.

- **Incorrect Phase Rotation**

The phase fail relay will open circuit if the heat pump has been wired with incorrect phase rotation or if a phase has failed. Both **green and yellow** LEDs on the relay will be illuminated if all phases are available and phase rotation is correct.

- **Heat pump circulator has failed**

If the heat pump circulator has failed, the heat pump will not operate and may trip on a fault. Phone your nearest Rheem Service Department or Accredited Service Agent (or Service Centre in NZ) to arrange for an inspection.

HIGH ELECTRICITY BILLS

With the installation of your new air sourced heat pump water heater, maximum electrical energy savings can be achieved. Should you at any time, feel your energy account is too high, we suggest you check the following points:

- Is the relief valve in the storage tanks running excessively?
- Are outlets (especially the showers) using more hot water than you think? (Refer to “[Not Enough Hot Water](#)” on [page 16](#)).
- Is there a leaking hot water pipe, dripping hot water tap, etc? Even a small leak will waste a surprising quantity of hot water and energy. Replace faulty tap washers, and have your plumber rectify any leaking pipe work.
- Consider recent changes to your hot water usage pattern and check if there has been any increase in tariffs since your previous account.
- The heat pump water heater operates at its most efficient at higher air temperatures. Prolonged periods of low ambient temperature will decrease the efficiency of the system and increase running costs.

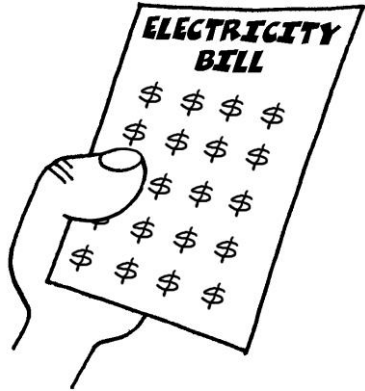

IF YOU HAVE CHECKED ALL THE FOREGOING AND STILL BELIEVE YOU NEED ASSISTANCE, CALL YOUR NEAREST RHEEM SERVICE DEPARTMENT OR ACCREDITED SERVICE AGENT.

INSTALLATION

**THIS WATER HEATER IS FOR INDOOR OR OUTDOOR INSTALLATION, MODEL DEPENDENT.
THIS WATER HEATER IS NOT SUITABLE FOR POOL HEATING.**

INSTALLATION STANDARDS

The water heater must be installed:

- by a qualified person, and
- in accordance with the installation instructions, and
- in compliance with Standards AS/NZS 3500.4, AS/NZS 3000 and all local codes and regulatory authority requirements.

In New Zealand, the installation must also conform with Clause G12 of the New Zealand Building Code.

WATER HEATER APPLICATION

This water heater is designed for the purpose of heating potable water. Its use in an application other than this may shorten its life

If this water heater is to be used where an uninterrupted hot water supply is necessary for the application or business, then there should be redundancy within the hot water system design. This should ensure the continuity of hot water supply in the event that this water heater was to become inoperable for any reason. We recommend you provide advice to the system owner about their needs and building backup redundancy into the hot water supply system.

COMPONENTS

The heat pump water heater system is modular and comprises three main components: the heat pump water heater, storage tanks and primary circulator. An auxiliary booster and/or circulator may also be employed as part of the system. The water heater must not be operated until all components are assembled.

Do not tilt the heat pump more than 45° from the vertical. This will unsettle the refrigerant gas and compressor lubricating oil. If the heat pump has been tilted more than 45° from the vertical during handling, it will need one hour to settle before the power to the water heater can be switched on, otherwise damage to the compressor may result.

INDOOR INSTALLATION

To comply with AS/NZS 1677.2, the minimum room size permissible in relation to the quantity of refrigerant in the water heater, is 7.5m³ per 16kW heat pump and 17.73 m³ per 35kW heat pump. A larger room size is recommended for efficient heat pump operation.

INSTALLATION

WATER HEATER LOCATION

953 series models are designed to be installed outdoors or indoors, if a sufficient supply of heat energy is available and the room meets the volume requirements stated above. Good performance is obtained when the heat pump is supplied with a constant supply of fresh air. Failure to observe the above recommendations may lead to lower than expected performance or problematic operation of the heat pump.

952 series models are designed for ducting of discharge air in indoor installations.

The water heater should be installed close to the storage tanks and its position chosen with noise, safety and service in mind. Make sure the air inlet and outlet grilles are clear of obstructions and shrubbery and they are unlikely to be touched by people (especially children).

It is advisable to install the water heater away from bedroom or living room windows as the system can generate a noise of 69dBA (at 3 metres from the water heater) whilst operating.

It is recommended the water heater be installed at ground or floor level. Stacked units with base unit at ground or floor level is acceptable from a servicing perspective.

The water heater must stand vertically upright.

Note: to assist with condensate drainage, the heat pump has a 2.5 degrees slope towards the drains. Do not level the product.

Clearance must be allowed for servicing of the water heater. Refer to [page 37](#) for clearance data. The water heater must be accessible without the use of a ladder or scaffold.

You must be able to read the information on the rating plate. Remember you may have to remove the entire water heater later for servicing.

The water heater must not be installed in an area with a corrosive atmosphere where chemicals are stored or where aerosol propellants are released. Remember the air may be safe to breathe, but the chemicals may attack the materials used in the heat pump system.

INSTALLATION

SAFE TRAY

Where damage to property can occur in the event of the water heater leaking or condensate forming under the drain tray, the water heater must be installed in a safe tray or be suitably banded. Construction, installation and draining of a safe tray must comply with AS/NZS 3500.4 and all local codes and regulatory authority requirements.

MAINS WATER SUPPLY

Where the mains water supply pressure exceeds that shown in the table below, an approved pressure limiting valve is required and should be fitted as shown in the installation diagram (refer to diagram on [page 46](#)).

Relief valve setting (VE/610 Series storage tanks)	1000 kPa
Expansion control valve setting *	850 kPa
Relief valve setting (SS/RT Series storage tanks)	850kPa
Expansion control valve setting *	700 kPa
Max-supply pressure (VE/610 Series storage tanks)	
Without expansion control valve	800 kPa
With expansion control valve	680 kPa
Max-supply pressure (SS/RT Series storage tanks)	
Without expansion control valve	680 kPa
With expansion control valve	550 kPa
* Expansion control valve not supplied with the water heater.	

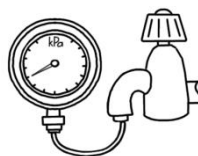

TANK WATER SUPPLY

If the storage tank is supplied with water from a tank supply and a pressure pump system is not installed, then the bottom of the supply tank must be at least 1 m above the highest point of the hot water plumbing system, including the storage tank. Care must be taken to avoid air locks. The cold water line to the storage tank should be adequately sized and fitted with a full flow gate valve or ball valve.

INSTALLATION

HOT WATER DELIVERY

This water heater can deliver water at temperatures which can cause scalding.

It is necessary and we recommend that a temperature limiting device be fitted between the storage tanks and the hot water outlets in any ablution area such as a bathroom or ensuite, to reduce the risk of scalding. The installing plumber may have a legal obligation to ensure the installation of this water heater system meets the delivery water temperature requirements of AS/NZS 3500.4 so that scalding water temperatures are not delivered to a bathroom, ensuite or other ablution area.

Where a temperature limiting device is installed adjacent to the storage tanks, the cold water line to the temperature limiting device can be branched off the cold water line either before or after the isolation valve, pressure limiting valve and non return valve to the water heater system. If an expansion control valve is required, it must always be installed after the non return valve and be the last valve prior to the storage tanks.

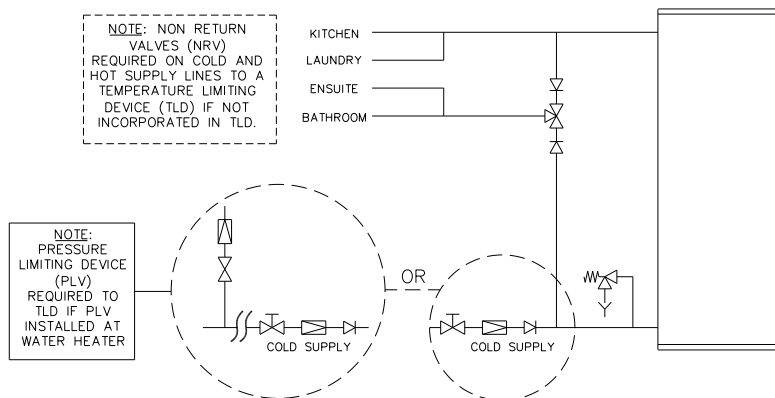

Two Temperature Zones Using a Temperature Limiting Device

If a pressure limiting valve is installed on the cold water line to the water heater system and the cold water line to a temperature limiting device branches off before this valve or from another cold water line in the premises, then a pressure limiting valve of an equal pressure setting may be required prior to the temperature limiting device.

CIRCULATED HOT WATER FLOW AND RETURN SYSTEM

This heat pump water heater may be installed as part of a circulated hot water flow and return system in a building as long as a temperature boosting water heater is not installed downstream of the heat pump.

INSTALLATION

If a temperature boosting water heater is installed the circulated hot water flow and return system must return to the inlet of the temperature boosting water heater, and not the heat pump, to avoid potential nuisance tripping. Refer to the diagram on page 27.

Temperature Limiting Device

A temperature limiting device cannot be installed in circulated hot water flow and return pipe work unless the device is designed for such application, such as Rheem Guardian. The tempered water from a temperature limiting device cannot be circulated. Where a circulated hot water flow and return system is required in a building, a temperature limiting device can only be installed on a dead leg, branching off the circulated hot water flow and return pipe.

If circulated tempered water were to be returned back to the water heater, depending on the location of the return line connection on the water supply line to the water heater, then either:

- water will be supplied to the cold water inlet of the temperature limiting device at a temperature exceeding the maximum recommended water supply temperature, or
- when the hot taps are closed no water will be supplied to the cold water inlet of the temperature limiting device whilst hot water will continue to be supplied to the hot water inlet of the temperature limiting device.

These conditions may result in either water at a temperature exceeding the requirements of AS/NZS 3500.4 being delivered to the hot water outlets in the ablution areas, or the device closing completely and not delivering water at all, or the device failing. Under either condition, the operation and performance of the device cannot be guaranteed.

INSULATION

To minimise heat loss and provide protection from freezing, the cold water line to and the hot water line from the heat pump water heater must be insulated in accordance with the requirements of AS/NZS 3500.4. The insulation must be weatherproof and UV resistant if exposed.

INSTALLATION

SADDLING - PIPE WORK

To prevent damage to the heat pump and storage tanks when attaching pipe clips or saddles to the water heater jacket, we recommend the use of self-drilling screws with a maximum length of 12 mm. Should pre drilling be required, extreme caution must be observed when penetrating the jacket of the water heater.

Avoid drilling or saddling in the vicinity of the evaporator coil. The coil and refrigerant circuit are in close proximity to the jacket and rupturing of the refrigerant circuit may occur.

Note: If the heat pump is damaged as a result of attaching pipe clips or saddling to the jacket, any resultant faults will not be covered by the Rheem warranty.

INSTALLATION

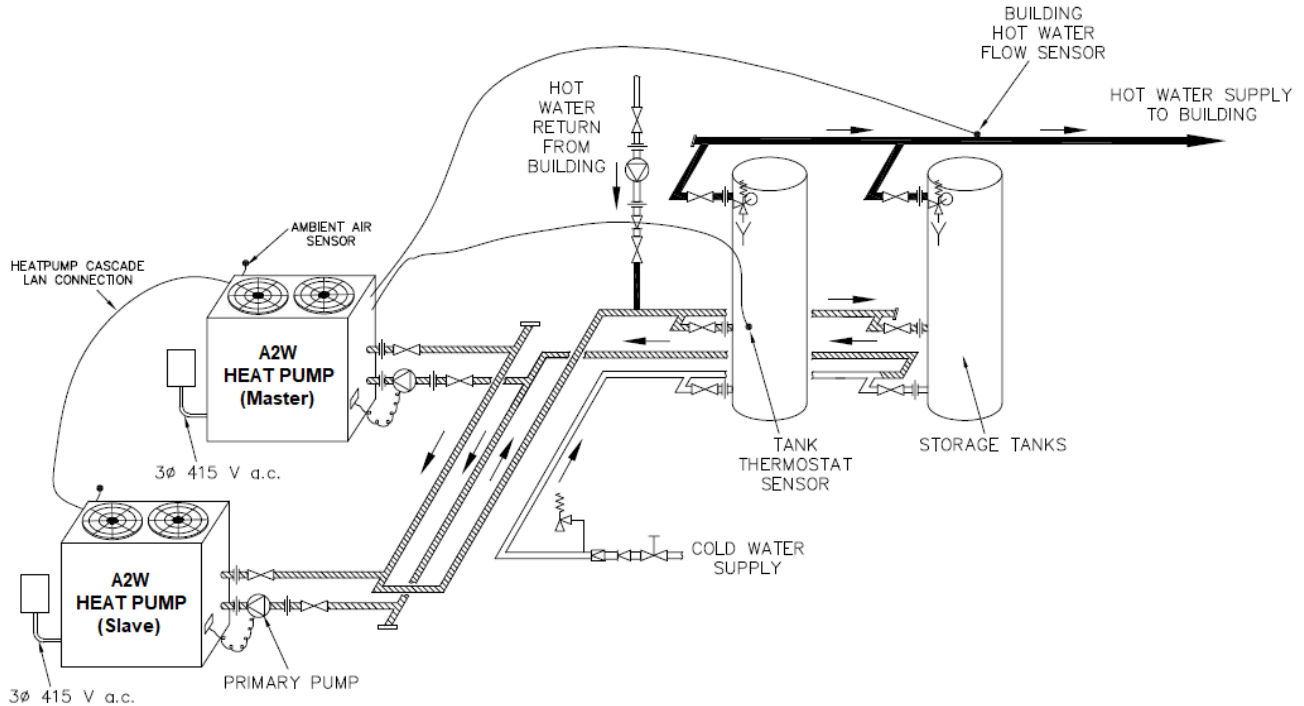

Typical A2W Heat Pump Installation with Recirculation

INSTALLATION

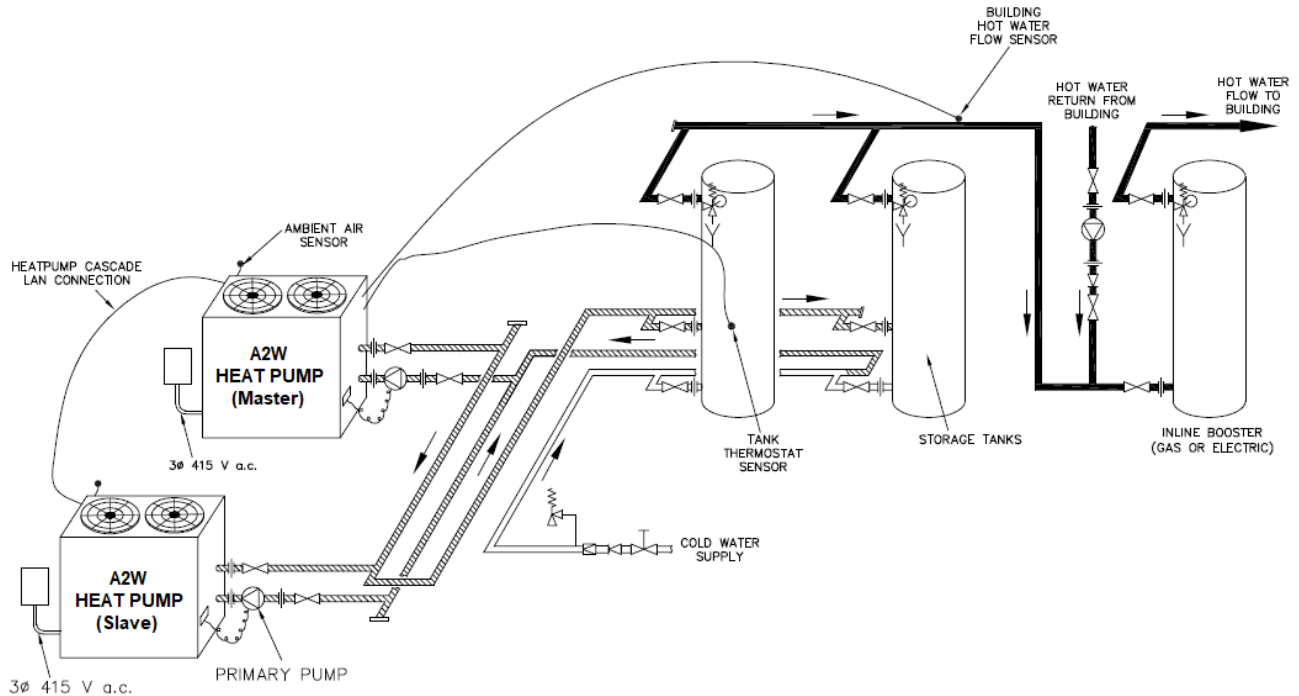

Typical A2W Heat Pump Installation with Inline Boost

INSTALLATION

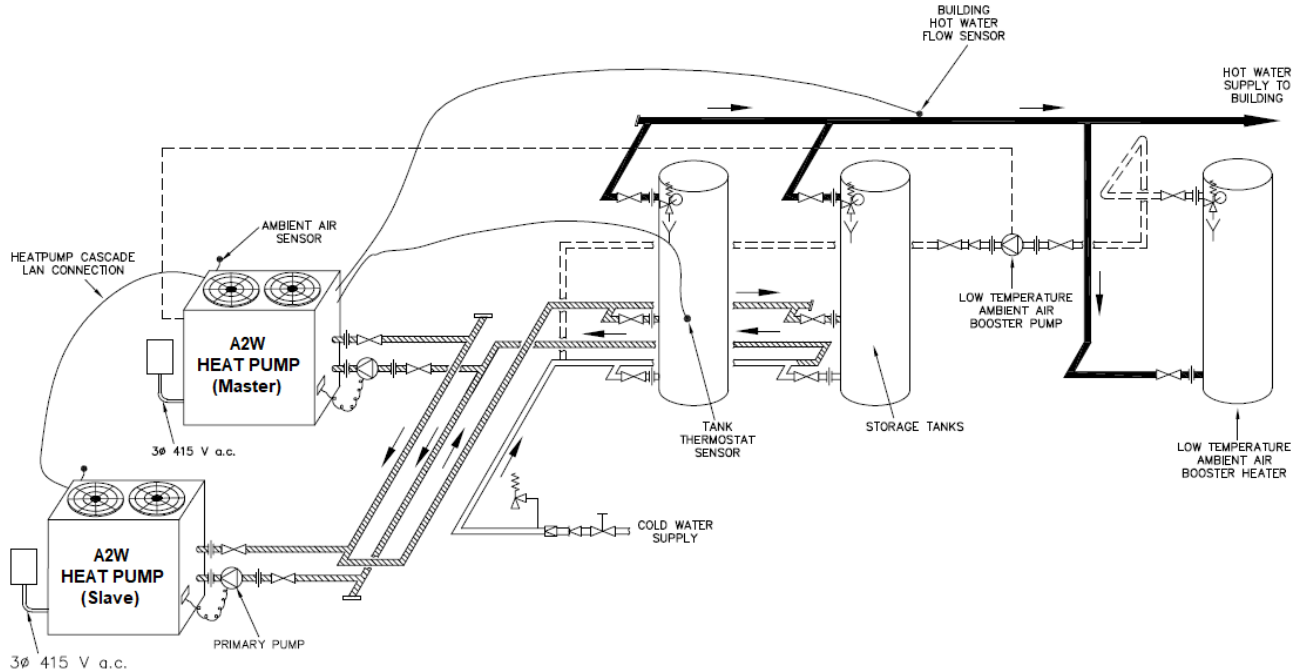

Typical A2W Heat Pump Installation with Low Ambient Air Boost- Dead Leg System

INSTALLATION

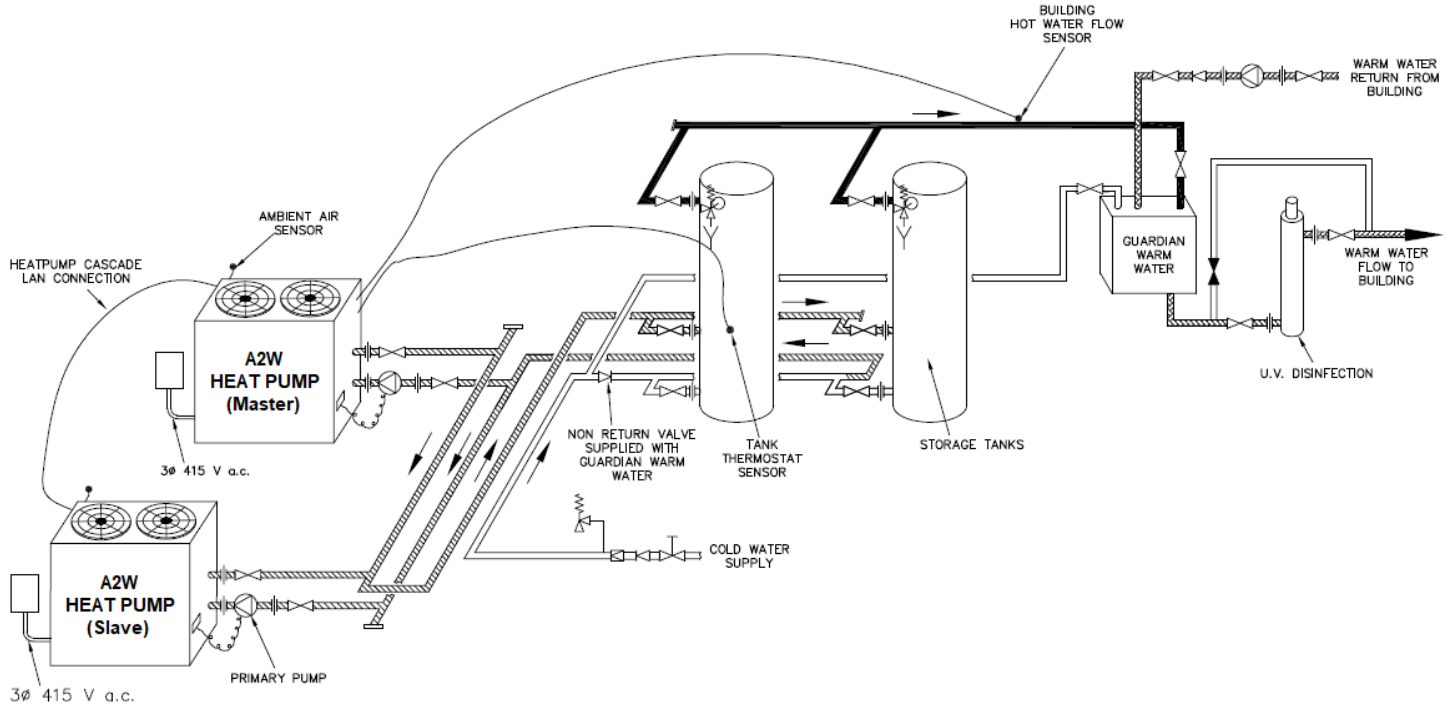

Typical A2W Heat Pump Installation with Guardian Warm Water

INSTALLATION

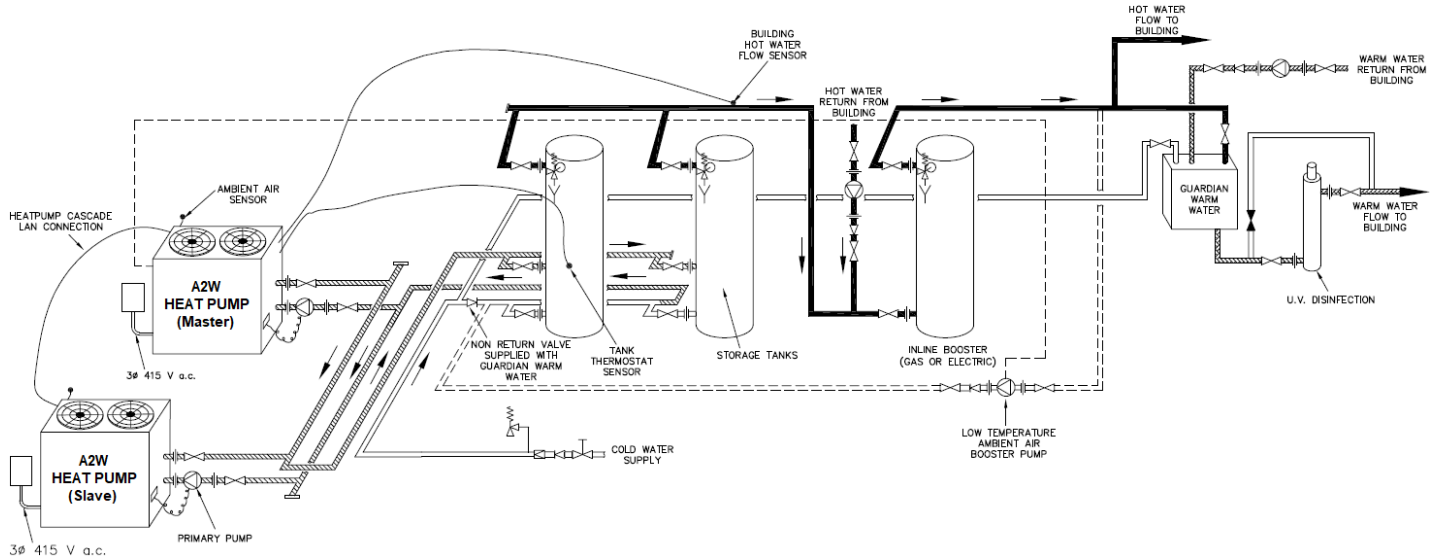

**Typical A2W Heat Pump Installation with Inline Boost, Low Ambient Air Boost
Hot Water Recirculation & Warm Water**

INSTALLATION

Dimensions and Technical Data- 16kW Models

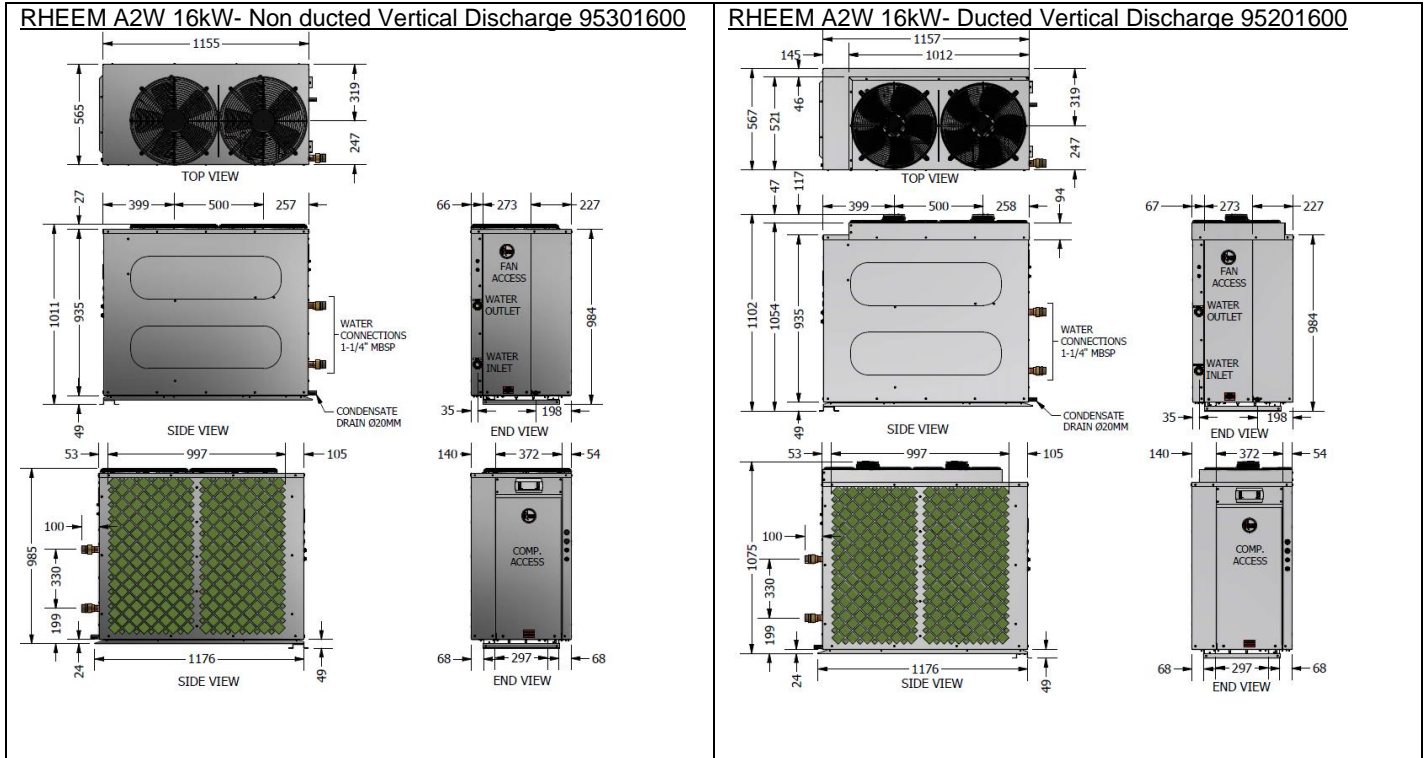

INSTALLATION

RHEEM A2W 16kW- Non ducted Horizontal Discharge 953016H0

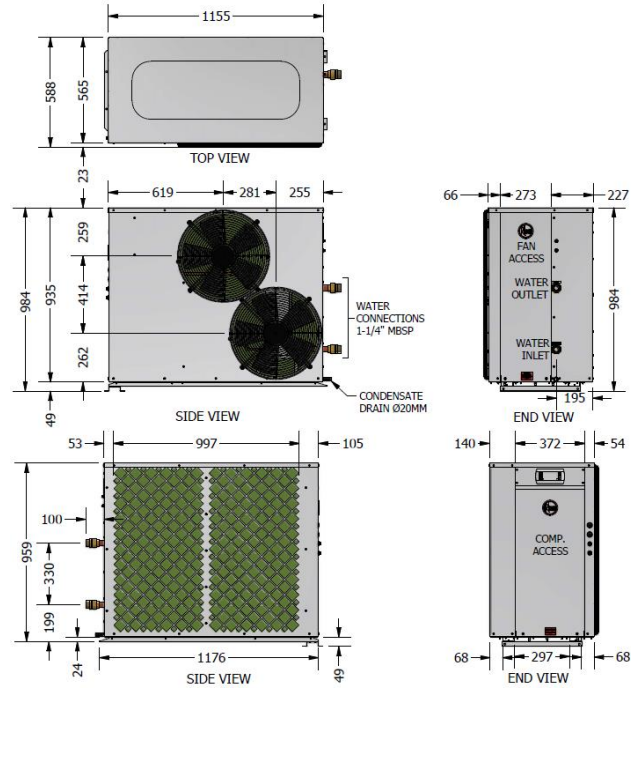

RHEEM A2W 16kW- Ducted Horizontal Discharge 952016H0

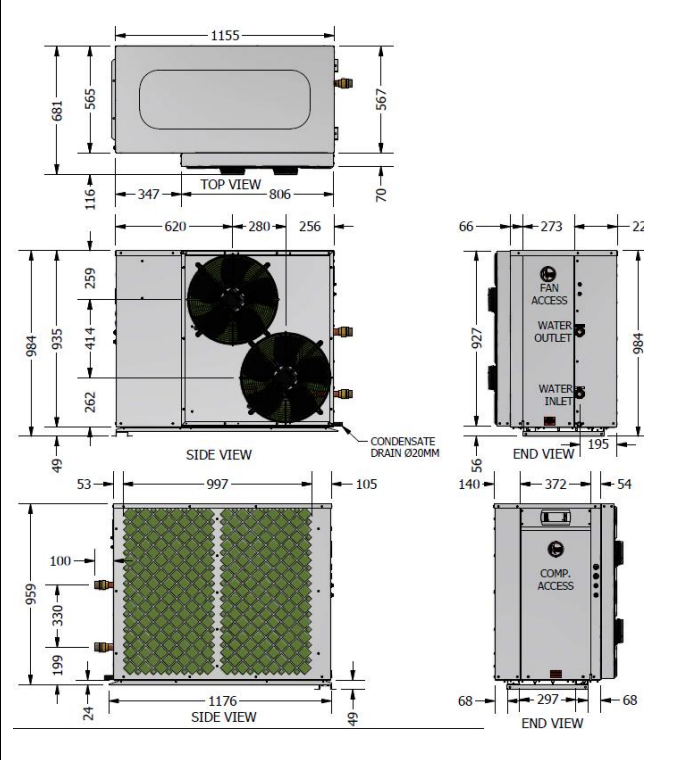

INSTALLATION

RHEEM A2W 16kW- Non ducted Horizontal Discharge Stackable 953016HS

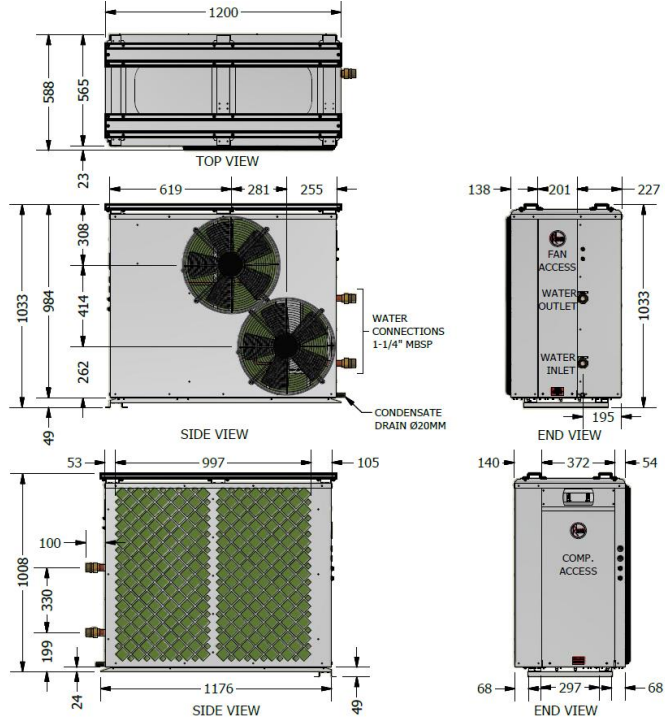

RHEEM A2W 16kW- Ducted Horizontal Discharge Stackable 952016HS

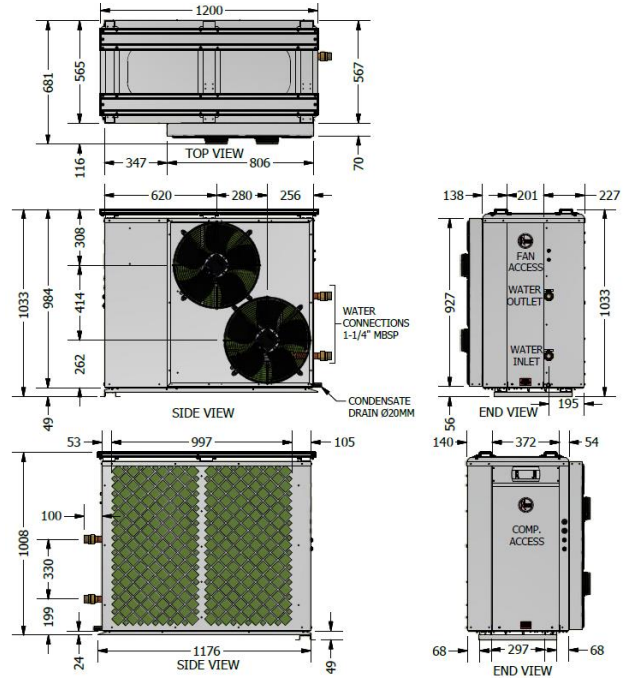

INSTALLATION

Dimensions and Technical Data- 35kW Models

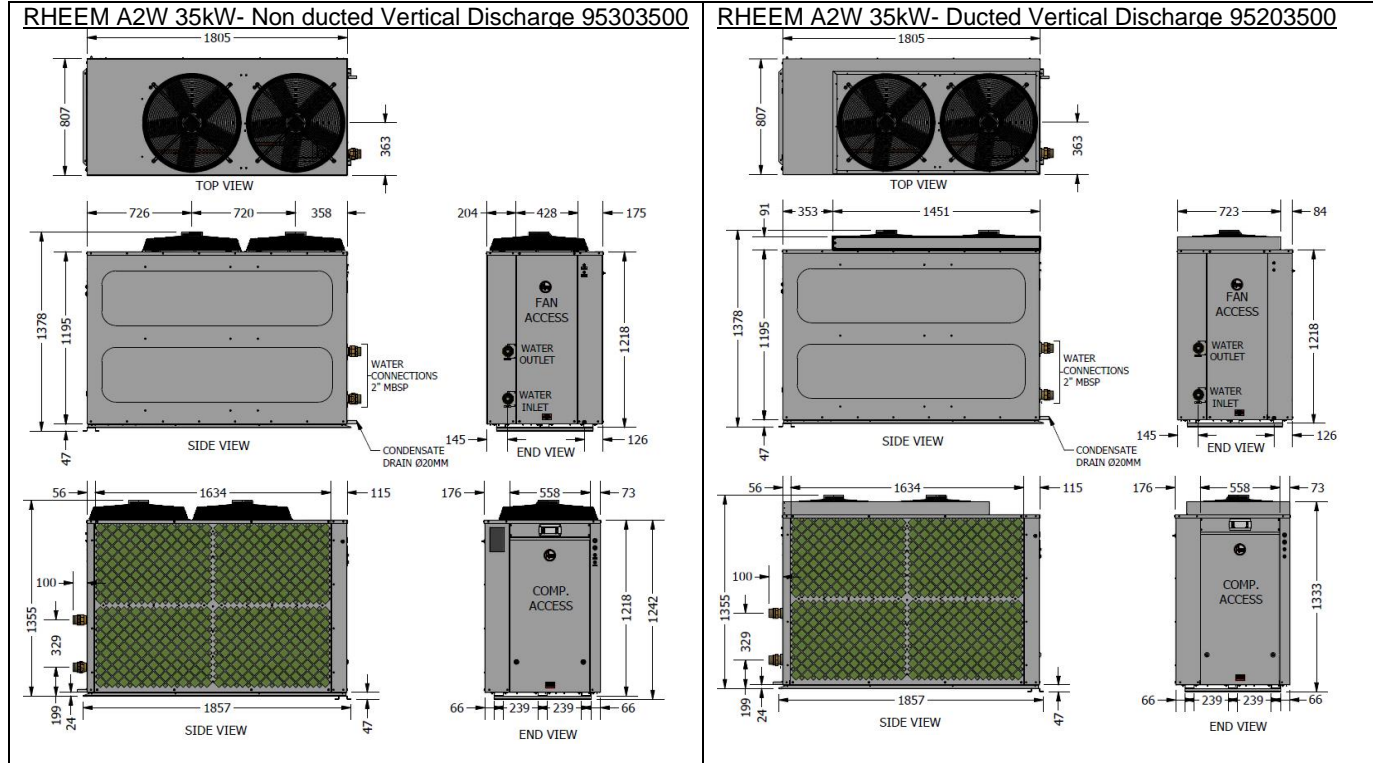

INSTALLATION

RHEEM A2W 35kW- Non ducted Horizontal Discharge 953035H0

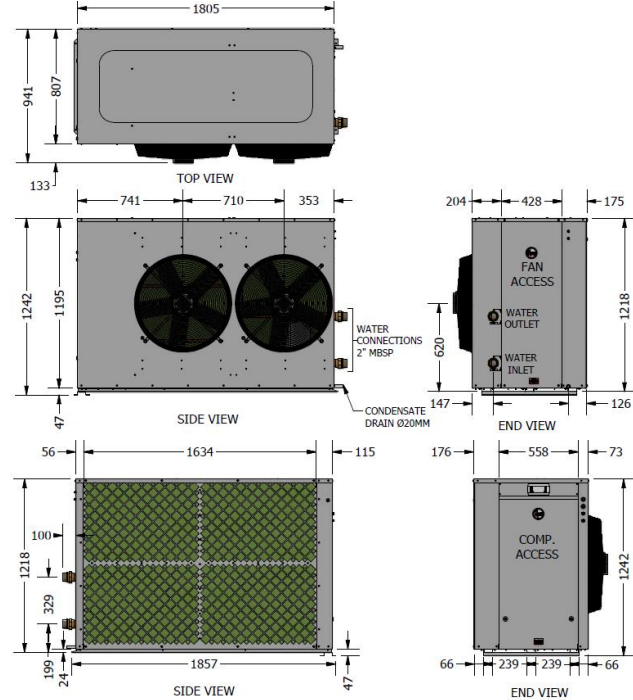

RHEEM A2W 35kW- Ducted Horizontal Discharge 952035H0

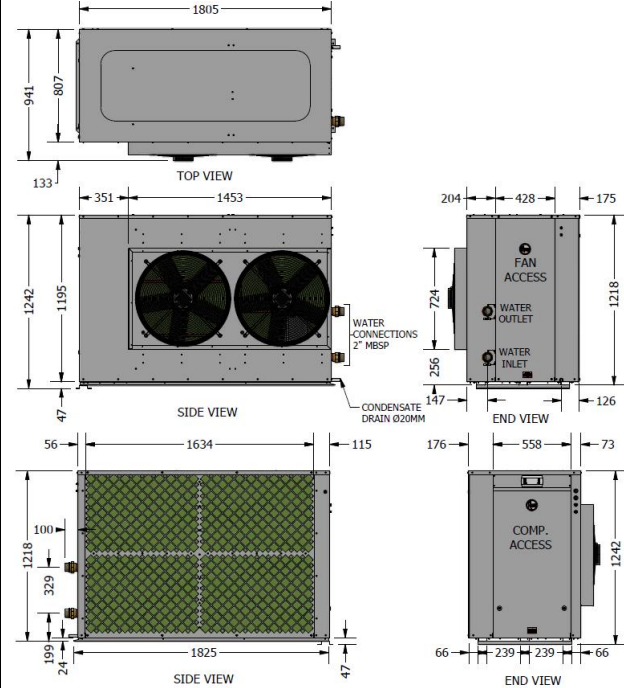

INSTALLATION

RHEEM A2W 35kW- Non ducted Horizontal Discharge Stackable 953035HS

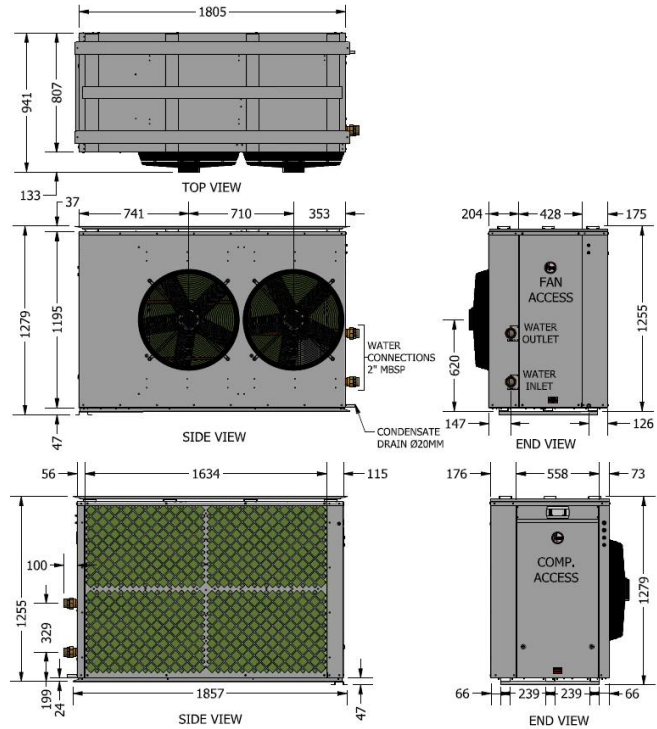

RHEEM A2W 35kW- Ducted Horizontal Discharge Stackable 952035HS

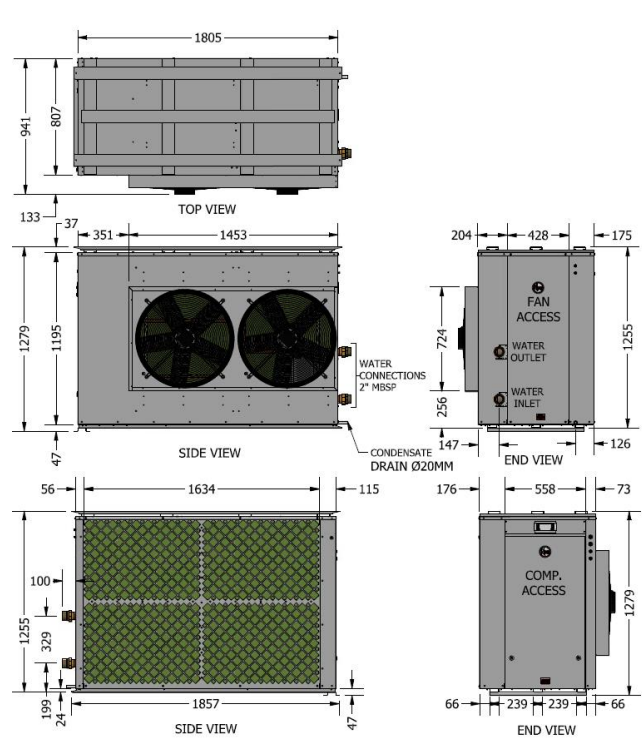

INSTALLATION

CLEARANCES- AIR TO WATER HEAT PUMP MODELS

Sides	Unit	16kW Models	35kW Models
Evap Coil Side	mm	500	1000
Back (vertical discharge models)	mm	Nil	Nil
Back (horizontal discharge models)	mm	1200	2000
Display Side	mm	850	850
Water Connections Side	mm	500	600
Top (vertical discharge models)	mm	1200	2000
Top (horizontal discharge option)	mm	Clearance above unit required for service personnel to stand	

HEAT PUMP AND TANK ASSEMBLY

HEAT PUMP AND STORAGE TANKS

The heat pump water heater system is modular and comprises three main components: the heat pump water heater, storage tanks and primary circulator. An auxiliary booster and/or circulator may also be employed as part of the system. The water heater must not be operated until all components are assembled.

HEAT PUMP

Locate the heat pump(s) in the appropriate position observing the required clearances for operation and servicing. **Refer to page 37.**

Indoor Installations

To comply with AS1677.2, the minimum room size permissible in relation to the quantity of refrigerant in the water heater, is 7.5m³ per 16kW heat pump and 17.73 m³ per 35kW heat pump. A larger room size is recommended for efficient heat pump operation.

Ducted models (prefix 952) are designed to be connected to ducting to convey cold discharge air away from the heat pump air inlet. Non ducted models (prefix 953) may be installed indoors, without ducting, if a sufficient supply of heat energy is available and the room meets the volume requirements stated above. Good performance is obtained when the heat pump is supplied with a constant supply of fresh air. Failure to observe the above recommendations may lead to lower than expected performance or problematic operation of the heat pump.

Ventilation

The heat pump draws fresh air at a rate of 1.6m³/s for 16kW heat pump and 5.8m³/s for 35kW heat pump. Minimum recommended free air inlet ventilation opening is 1m² per 16kW heat pump and 1.93m² per 35kW heat pump.

HEAT PUMP AND TANK ASSEMBLY

Ducted Models

The exhaust air duct must be constructed so that it covers both fans. A spigot is provided on ducted models to facilitate ductwork connection. The maximum static pressure in the ductwork must not exceed the values stated in the table below.

Maximum Static Pressure			
16kW Heat Pump		35kW Heat Pump	
Ducted	Non ducted	Ducted	Non ducted
80Pa	20Pa	100Pa	20Pa

Horizontal Ducting

If ducting horizontally, the vertical dimension of the duct must be at least 800 mm high. It is recommended to terminate the ducting with bird mesh as this provides the least pressure resistance to the fans against air flow. If louvres are to be used, the duct size must be increased. The duct should have a slight fall away from the heat pump and the terminal face be tapered downwards to prevent water ingress.

Vertical Ducting

If ducting vertically, the duct must terminate 500 mm above the roof level and have a free ventilation outlet area equivalent to 1.0 m² per heat pump for 952016 models and 1.93 m² per heat pump for 952035 models. It is recommended to terminate the duct with bird mesh as this provides the least pressure resistance to the fans against air flow. Adequate weather protection must be provided to prevent water ingress.

Horizontal Fan Option

If a horizontal discharge fan option has been selected, the same rules apply to location of installation as for ducted and non ducted models, depending on which has been ordered. If installed indoors, observe the same requirements as shown in indoor installations on [page 20](#).

HEAT PUMP AND TANK ASSEMBLY

Stackable Model Installations

Stackable models can be stacked two high to reduce footprint as shown in the diagram below.

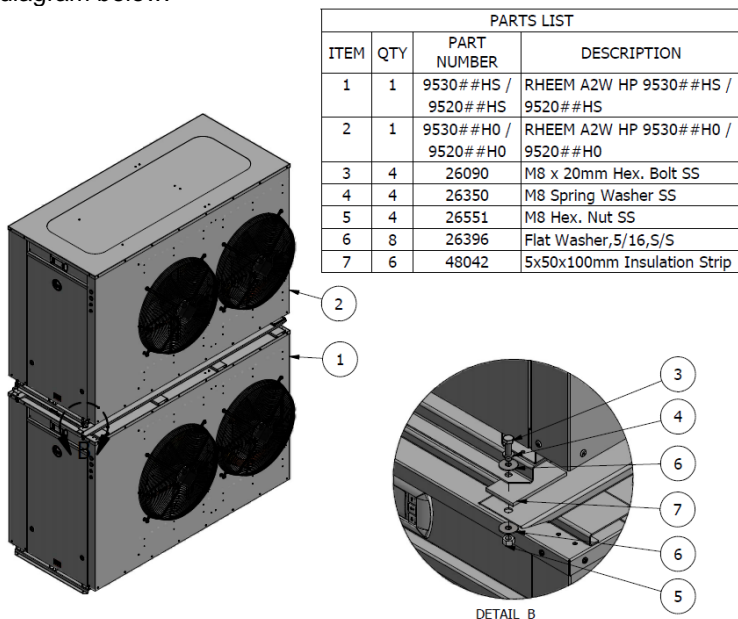

Note: Top unit can be 9530XXH0 or 9520XXH0.

STORAGE TANKS

Rheem Commercial storage tanks are employed to store the hot water generated by the heat pump. The tanks must be manifolded using the Equa-Flow[®] manifold system to ensure even distribution of the stored energy. Up to ten tanks can be manifolded together in a single bank. More than one bank can be used. Follow the diagram on [page 44](#) when manifolding the tanks.

Refer to the installation instructions supplied with the storage tanks for specific information relating to the installation of the storage tanks.

PRIMARY CIRCULATOR

Each heat pump requires a primary circulator to ensure the correct flow rate and temperature rise is achieved. Where more than one heat pump is installed the common manifold must be installed using the Equa-Flow[®] manifold system and must be sized to accommodate the total flow of all the primary pumps running simultaneously.

HEAT PUMP AND TANK ASSEMBLY

Refer to table below for minimum (ID) pipe sizing.

The designed primary pump per 16kW model is Grundfos model CM3-2 and per 35kW model is CM10-1. Refer to installation manuals supplied with pumps. If another pump has been supplied, consult Rheem before continuing with the installation.

A2W HP 16kW					A2W HP 35kW				
No. of Heat Pumps in Parallel	1	2	3	4	No. of Heat Pumps in Parallel	1	2	3	4
Pump	Grundfos CM3-2				Pump	Grundfos CM10-1			
Branch Size (mm)	40				Branch Size (mm)	50			
Header Size (mm)	40	50	65	80	Header Size (mm)	50	80	100	100

Header pipe sizing is based on one pump per heat pump with a total length of 20m of primary flow and return piping and 20 x 90° bends, excluding Equa-flow manifolds on storage tanks and heat pumps, at 1.2m/sec velocity. If this specification is exceeded consult Rheem before continuing with the installation.

Multiple heat pumps **MUST** be installed using Equa-Flow® principles to ensure the demand on each heat pump (or storage tank) in the bank is the same as any other. To achieve this, the following is necessary:

1. The **inlet** manifolds must be designed to balance the flow to each heat pump i.e. each branch line must be the same diameter and length.
2. The **outlet** manifold must be designed to balance the flow from each heat pump i.e. each branch line must be the same diameter and length.
3. The first heat pump in must be the last heat pump out.

Note: Inlet and outlet water isolation valves **MUST** be installed at each heat pump to enable each heat pump to be individually isolated for servicing. The inlet isolation valve **MUST** be installed before the pump to also enable the pump to be isolated for servicing.

AUXILIARY WATER HEATER

It may be necessary to install an auxiliary water heater under the following conditions:

- If the ambient temperature is likely to drop below 5°C during periods when heating may be required.
- To ensure sufficient hot water is available for higher than expected peak conditions.
- If higher temperature water is required for certain applications, eg commercial laundry or kitchen.

HEAT PUMP AND TANK ASSEMBLY

The configuration of the auxiliary water heating plant can vary depending on the requirements of the individual installation.

Low Ambient Temperature Heating Only - Where the auxiliary water heater is required to be activated if the heat pump cannot operate due to low ambient conditions, the heat pump can activate the auxiliary heater or pump. There are many configurations depending on system design. Refer to Application Guide for details on the auxiliary boost function designed for this system.

In Line Boosting Only - Where the auxiliary water heater is required to ensure sufficient hot water is available for periods after the main peak or to boost the temperature of the water produced by the heat pump for other purposes (eg high temperature for kitchen and laundry use), an auxiliary water heater must be installed in series with the storage tanks. ie, the hot water outlet from the storage tanks must feed into the inlet of the auxiliary water heater(s).

Note: Where RT storage tanks are used, boosting in the top portion of the storage tank is equivalent to boosting in series.

Where multiple auxiliary water heaters are required to be manifolded together, these must be manifolded using the Equa-Flow® manifold system and the manifold in-series with the storage tanks. Refer to [page 44](#).

This arrangement can also be adapted to include recirculation heat loss make up and / or low ambient temperature activation heating. Refer to Application Guide for options.

MANIFOLD INSTALLATIONS

The Rheem commercial heat pump water heater is designed to be installed with storage tanks on a single manifold or multiple manifolds if required, using the Rheem Equa-Flow® manifold system. The Equa-Flow principle will function with water heaters in line, around a corner or in rows back to back (refer to the diagrams on **pages 44 to 45**).

The cold water, primary flow and hot water manifolds must be designed to balance the flow from each water heater and storage tank. To achieve this, there are basic installation requirements and principles which must be followed:

1. The maximum number of storage tanks in a bank should be 10, however several banks of storage tanks can be installed.
2. The hot water line from the manifold must leave from the opposite end to which the cold water line enters the manifold.
3. The storage tanks must be of the same model.
4. The cold water line, cold and hot headers and hot water line must be sized to meet the requirements of both AS/NZS 3500.4 and the application.
5. A non-return valve, isolation valve and if required a pressure limiting valve and expansion control valve, must be installed on the cold water line to the system.
6. A full flow gate valve or ball valve (not a stop tap, as used on a single water heater installation) must be installed on both the cold water branch and hot water branch of each water heater and storage tank.
7. Non return valves or pressure limiting valves **MUST NOT** be installed on the branch lines to the water heaters or storage tanks.
8. All fittings, valves and branch lines must be matched sets all the way along the manifold.
9. Sufficient space must be left to enable access, servicing or removal of any water heater or storage tank.
10. The temperature pressure relief valve drain line from each storage tank can terminate at a common tundish (funnel) with a visible air break at each drain discharge point.

MANIFOLD INSTALLATIONS

Manifold Arrangement

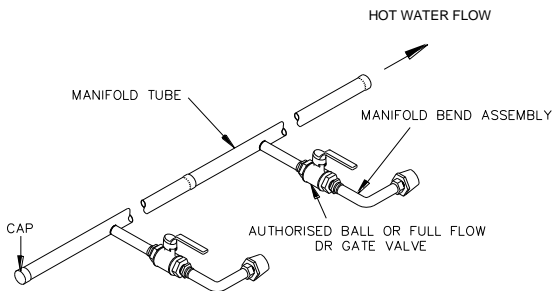

Hot Manifold Assembly

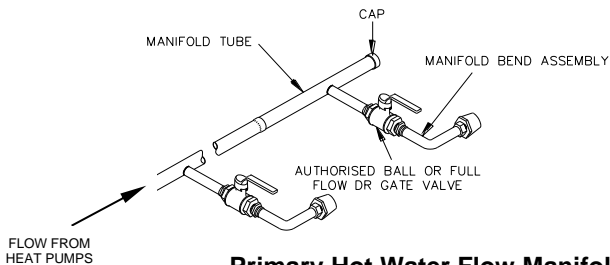

Primary Hot Water Flow Manifold Assembly

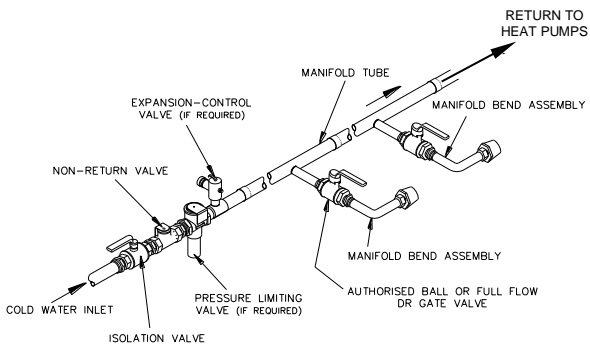

Cold Manifold Assembly

MANIFOLD INSTALLATIONS

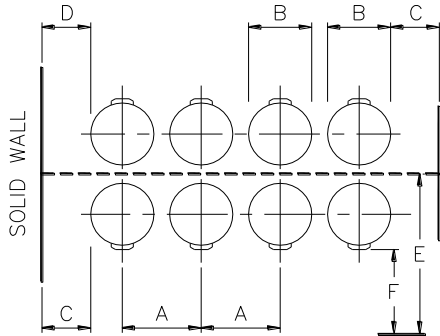
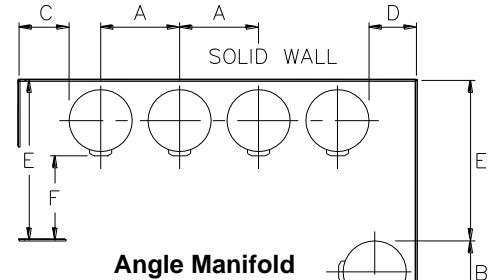
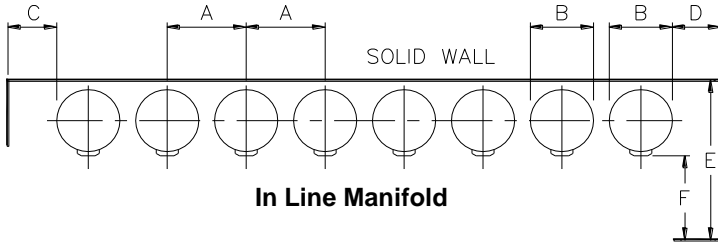

NOTES:
 Minimum recommended space between wall and back of water heater is 100 mm.
 A minimum of 900 mm (E* & F*) should be left in front of the water heater for access, servicing and water heater removal.

Installation Layout Minimum Dimensions

Model	A	B	C	D	E *	F *
610 430	935	685	300	100	1685	900
RT1000	1250	1000	300	100	2100	1000
RT2000	1550	1300	300	100	2700	1300
RT3000	1700	1450	300	100	3000	1450
RT4000	1850	1600	300	100	3300	1600
RT5000	2050	1800	300	100	3700	1800

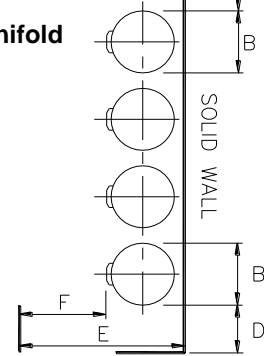

INSTALLATION DIMENSIONS – MULTIPLE RHEEM STORAGE TANKS

CONNECTIONS – PLUMBING

CONNECTION SIZES

Model	16kW	35kW
Heat pump water heater inlet connection	R1¼ BSPM	R2 BSPM
Heat pump water heater outlet connection	R1¼ BSPM	R2 BSPM
Condensate drain connection	20mm O.D	

All plumbing work must be carried out by a qualified person and in accordance with the Plumbing Standard AS/NZS 3500.4 and local authority requirements.

WATER INLET AND OUTLET

The pipe work must be cleared of foreign matter before connection and purged before attempting to operate the water heater. All olive compression fittings must use brass or copper olives. Use thread sealing tape or approved thread sealant on all screwed fittings.

An isolation valve and non-return valve must be installed on the cold water line to the water heater system. An acceptable arrangement is shown in the diagram. Refer also to “Hot Water Delivery” on [page 23](#) and to “Mains Water Supply” on [page 22](#).

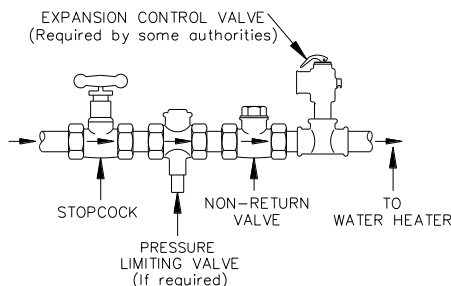

Disconnection unions are provided at the cold water inlet and hot water outlet on the water heater to allow for disconnection of the water heater.

PIPE SIZES

To achieve true mains pressure operation, the cold water line to the storage tanks should be the same size or bigger than the hot water line from the storage tanks.

The pipe sizing for hot water supply systems should be carried out by persons competent to do so, choosing the most suitable pipe size for each individual application. Reference to the technical specifications of the water heater and local regulatory authority requirements must be made.

Refer to the table on [page 41](#) for correct primary flow and return pipe sizing.

RELIEF VALVE

The heat pump is supplied with an integral pressure relief valve located on the inside of the heat pump cabinet and will discharge into the tray of the heat pump. Refer to Condensate Drain on [page 47](#) for drainage instructions.

CONNECTIONS - PLUMBING

EXPANSION CONTROL VALVE

Local regulations may make it mandatory to install an expansion control valve (ECV) in the cold water line to the water heater system. In other areas, an ECV is not required unless the saturation index is greater than +0.4 (refer to "Water Supplies" on [page 14](#)). However, an ECV may be needed in a corrosive water area where there are sufficient quantities of silica dissolved in the water.

The expansion control valve must always be installed after the non return valve and be the last valve installed prior to the water heater system (refer to diagram on [page 43](#)).

EXPANSION CONTROL VALVE DRAIN

A copper drain line must be fitted to the relief valve to carry the discharge clear of the water heater. Connect the drain line to the relief valve using a disconnection union. The pipe work from the relief valve to the drain should be as short as possible and fall all the way from the water heater with no restrictions. It should have no more than three right angle bends in it. Use DN15 pipe.

The outlet of the drain line must be in such a position that flow out of the pipe can be easily seen (refer to AS/NZS 3500.4) - but arranged so hot water discharge will not cause injury, damage or nuisance. The drain line must discharge at an outlet or air break not more than 9 metres from the relief valve.

In locations where water pipes are prone to freezing, the drain line must be insulated and not exceed 300 mm in length. In this instance, the drain line is to discharge into a tundish through an air gap of between 75 mm and 150 mm.

CONDENSATE DRAIN

A drain line must be fitted to the condensate drains to carry the discharge clear of the water heater. The drain line can be extended using 20 mm O.D. rigid hose or conduit. Where installed externally, the drain line pipe work must be UV resistant or protected from sunlight. The outlet of the drain line must be in such a position that flow out of the pipe can be easily seen - but arranged so water discharge will not cause damage or nuisance. The water heater is supplied with fall and it is recommended to install the water heater with a slight fall towards the condensate drain.

The condensate drain must not be connected to the pressure relief or expansion control valve drain line but may discharge at the same point.

CONNECTIONS – ELECTRICAL

The power supply to the water heater must not be switched on until the water heater is filled with water and a satisfactory megger reading is obtained.

Megger Reading

When a megger test is conducted on this water heater, then the following should be noted.

⚠ Warning: This water heater contains electronic equipment and 500 V insulation tests must only be conducted between actives and earth and between neutral and earth. An active to neutral test WILL damage the electronics.

An insulation test result of above 1 MΩ should be obtained for this water heater.

Electrical Connection

All electrical work and permanent wiring must be carried out by a qualified person and in accordance with the Wiring Rules AS/NZS 3000 and local authority requirements.

Heat Pump

The heat pump water heater must be directly connected to a 415 V AC 50 Hz mains power supply. The heat pump must be on its own circuit with an isolating switch installed at the switchboard. A secondary isolating switch must be installed within reach of the water heater.

A conduit is required for the electrical cable to the heat pump water heater. The conduit is to be connected to the unit with a 20mm terminator. Holes are provided on the electrical panel for cabling. Connect the power supply and earth wires directly to the terminal block, ensuring there are no excess wire loops inside the electrical enclosure. Correct phase connection is required.

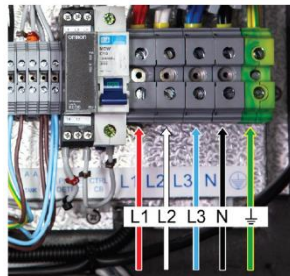

Electrical Data Table

Model	16kW Non-Ducted	16kW Ducted	35kW Non-Ducted	35kW Ducted
Electrical Connection	3 Phase / 415 Volts / 50 Hz			
Max Current per Phase (running, incl pump)	15.22 A	17.06A	32.34A	34.9A
Minimum Circuit Size (per phase)	20A		40A	

Primary Pump

The power to the primary pump for each heat pump is supplied from the water heater. Connect the active, neutral and earth wire to the pump terminals as shown in the diagram inside the pump cover and to the terminals located within the heat pump electrical enclosure.

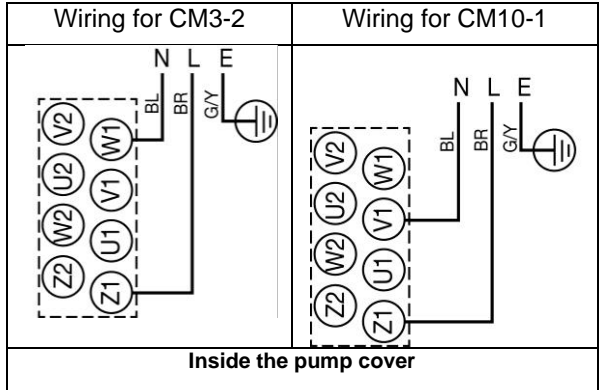

A 20 mm conduit is required for the electrical cable between the water heater and pump. The conduit is to be connected to the water heater with a 20 mm terminator.

Holes are provided on the electrical panel for cabling.

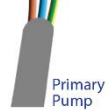
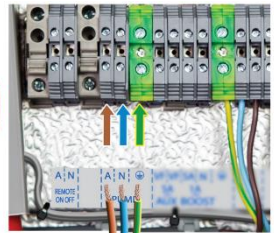
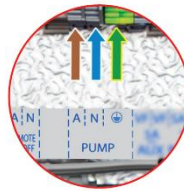
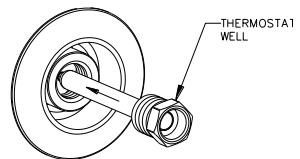

Photo inside the heat pump enclosure

Tank Sensor Installation

Connect one of the supplied temperature sensors to the connection terminal on the heat pump marked "Tank Sensor".

- Run out the sensor to the nearest storage tank.
- For 610 series tanks, a thermostat well is supplied within each tank.



- For RT series tanks, a thermostat well is supplied which needs to be fitted to the fitting (2nd from the bottom) as shown.
- Remove the plastic cover from the fitting located

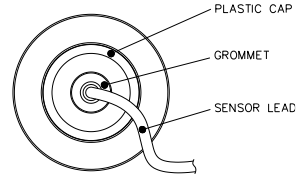
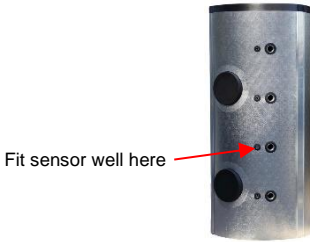

90° from the water connections on the storage tank, but do not discard.

- Make a small hole in the centre of the plastic cap and thread the sensor through the hole.
- Insert the sensor all the way into the thermostat well and fit the plastic cap back onto the storage tank.
- To prevent the sensor dislodging from the well, screw the cable to the tank jacket using a cable clamp.
- Cable tie the sensor lead, curling up and tying off any excess lead.

Building Flow Temperature Sensor Installation

- Connect the 2nd temperature sensor to the connection terminal on the heat pump marked “Building Flow Sensor”.
- Run out the sensor to the building flow pipe.
- Fit a thermostat well (not supplied) in the pipe ensuring the end of the sensor is in the flow of water. To prevent the sensor dislodging from the well, secure the sensor to the insulation using a cable tie. Alternatively, clamp the sensor to the outside of the pipe using a pipe clamp prior to the insulation being fitted.

Note: For multiple heat pump installation, the preferred method is to interconnect the heat pumps (up to 4 maximum) via LAN cables, available as an accessory (part number: 17534).

In this case, only one tank sensor and building flow temperature sensor is required, which are connected to the heat pump designated as the Master.

Alternatively, each heat pump can operate independently in which case each tank sensor and building flow temperature sensor must be connected and fitted as described above.

Low Ambient Boost

If auxiliary boosting is required for low ambient operation, the booster should be interlocked with the heat pump to only operate under low ambient or fault conditions.

Auxiliary Boost Element

Depending on the installation, an auxiliary boost element may be supplied with an RT series storage tank.

If a single auxiliary boost element is supplied by Rheem, remove bridging wire at the terminals marked 'A7 and A9' behind the element controller cover and connect the terminal A7 and A9 to the voltage free terminal marked 'VF' in the heat pump enclosure to control the operation of the boost element.

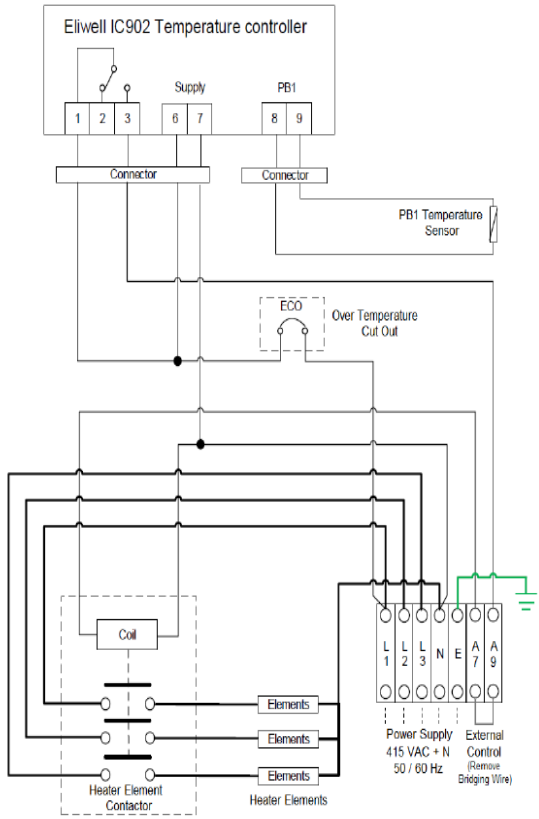

Electric Heating Unit – Wiring Diagram

CONNECTIONS - ELECTRICAL

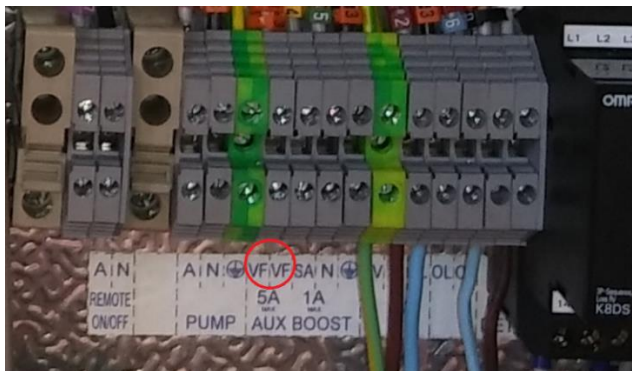

Picture of heat pump terminal strip

Where multiple auxiliary boost elements are required, and the number of auxiliary boost elements matches the number of heat pumps, each element may be interlocked with an individual heat pump directly using the method described above. In this case, the heat pumps should operate independently and each have their own tank and building flow temperature sensor connected.

Where the number of auxiliary boost does not match the number of heat pumps or the heat pumps are connected in a Master/Slave arrangement using LAN cables (refer to [page 53](#)), then the heat pumps must be connected via LAN cables and control of the auxiliary boost elements will be via the Master heat pump using an intermediary relay arrangement. Refer to Application Guide for more detail.

Auxiliary Boost Heater (external to storage tank)

Depending on the installation, an auxiliary heater and/or boost pump may be supplied. Refer to Application Guide for auxiliary boost options.

In the heat pump enclosure, terminals marked “SA”, “N” and “GND” provide 240V to control the auxiliary heater and/or auxiliary pump or multiple boost elements depending on the system design. Maximum current is 1A. Refer to Application Guide for further information to connect auxiliary boost heater.

Note: Where multiple heat pumps are required, the heat pumps must be connected in a Master/Slave arrangement using LAN cables (refer to [page 53](#)), and control of the auxiliary boost heaters will be via the Master heat pump. Refer to Application Guide for more details.

CONNECTIONS - ELECTRICAL

Multiple Heat Pump Installation

Up to four heat pumps can be interconnected by daisy chaining the LAN cables for operation as shown below. LAN cable is available as an accessory (part number: 17534).

Step 1:



1st Heat Pump- Master

2nd Heat Pump

3rd Heat Pump

4th Heat Pump

Interconnect the heat pumps as shown above by using the LAN cables. Determine the 1st heat pump as Master. Route the cables neatly to prevent damage and trip hazards. Do not route across access panels.

Note: Any of the two LAN connections will be acceptable.

Step 2:

In 2nd heat pump enclosure: Connect “DI3” with “DIC1”. Connect “DIC1” with the existing wire as shown in the picture.

Note: Terminal plug can be removed for ease of making connections by pulling downwards as shown in the picture.



CONNECTIONS - ELECTRICAL

In 3rd heat pump enclosure:
Connect “DI4” with “DIC1”.
Connect “DIC1” with the existing
wire as shown in the picture.

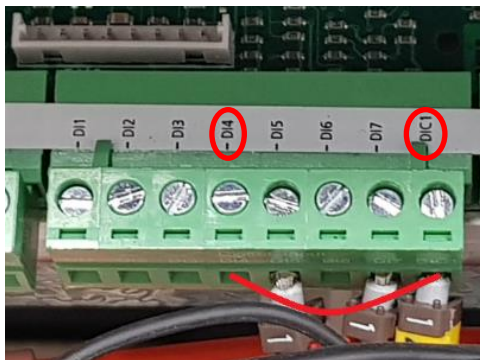

In 4th heat pump enclosure:
Connect “DI3” with “DI4” and
“DIC1”. Connect “DIC1” with the
existing wire as shown in the
picture.

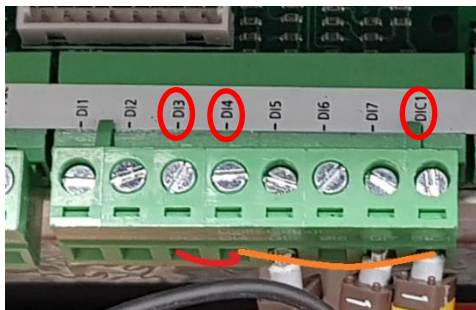

Note

1. Tank temperature sensor for the Master heat pump must be connected, otherwise the heat pumps will not operate due to fault. There is no need to connect tank temperature sensors for Slave heat pumps.
2. Building temperature sensor for the Master heat pump must be connected. There is no need to connect building temperature sensors for Slave heat pumps.
3. Ignore the values for tank and building temperature sensors on the display of Slave heat pumps as these are not connected.

CONNECTIONS - ELECTRICAL

Building Management Systems (BMS/BAS)

Each water heater can be connected to a BMS or BAS system via interface cards (Modbus RS485 or BACnet MS-TP or BACnet TCP/IP Ethernet), available as an accessory.

Based on site requirement, a suitable interface card needs to be connected to Rheem IQ control panel as shown in the diagram below.



- If the system is comprised of single or multiple standalone heat pumps, each heat pump will have its own BMS card.

Insert the BMS card into the connector for each heat pump, taking care that the card is firmly placed as shown in red circle.

- If the system is comprised of multiple heat pumps for Master/Slave operation, only master heat pump will have a BMS card and the slave heat pumps will be connected via LAN cables.

Follow the instruction on [page 53](#) for Interconnecting Multiple Heat Pumps from step 1 to step 2.

Insert the BMS card into the connector for master heat pump, taking care that the card is firmly placed as shown in red circle.

CONNECTIONS - ELECTRICAL

16KW HEAT PUMP (NON-DUCTED) WIRING DIAGRAM -953016 MODELS

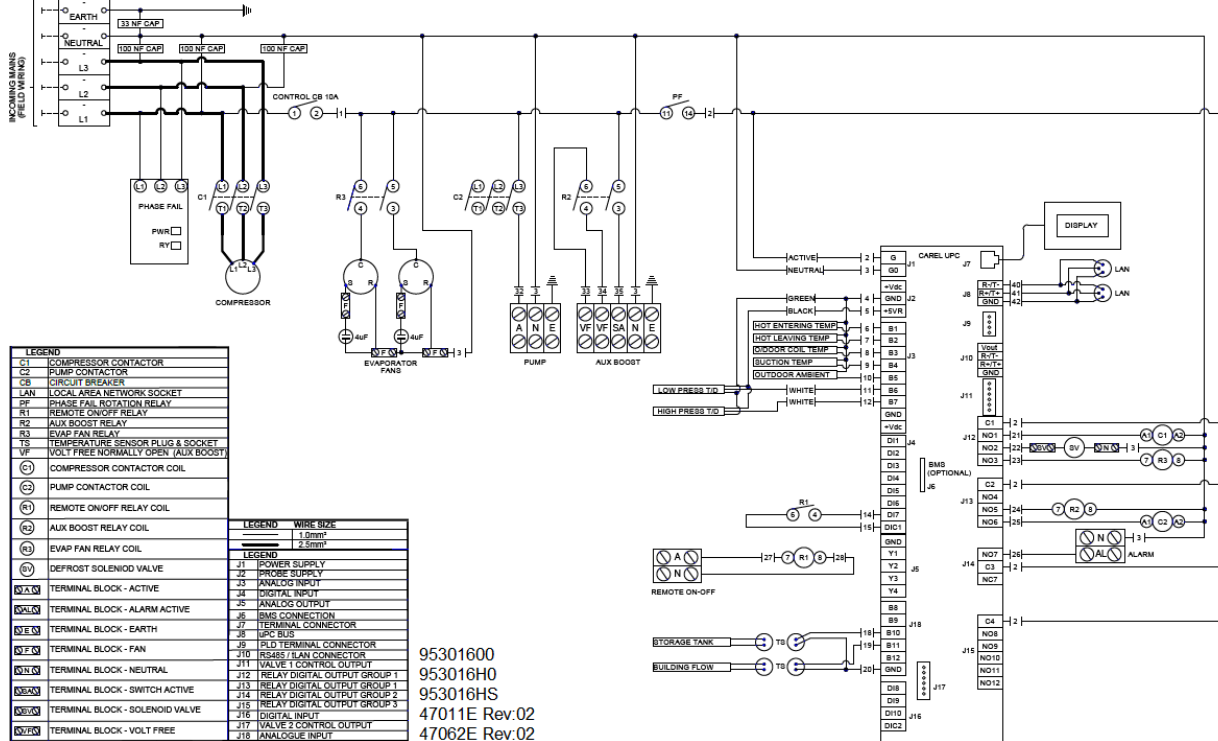

LEGEND	
C1	COMPRESSOR CONTACTOR
C2	PUMP CONTACTOR
CB	CIRCUIT BREAKER
LAN	LOCAL AREA NETWORK SOCKET
PF	PHASE FAIL ROTATION RELAY
R1	REMOTE ON/OFF RELAY
R2	AUX BOOST RELAY
R3	EVAP FAN RELAY
TS	TEMPERATURE SENSOR PLUG & SOCKET
VO	VOLT FREE NORMALLY OPEN (AUX BOOST)
(C)	COMPRESSOR CONTACTOR COIL
(C)	PUMP CONTACTOR COIL
(R)	REMOTE ON/OFF RELAY COIL
(R)	AUX BOOST RELAY COIL
(R)	EVAP FAN RELAY COIL
(V)	DEFROST SOLENOID VALVE
NA(A)	TERMINAL BLOCK - ACTIVE
NA(LA)	TERMINAL BLOCK - ALARM ACTIVE
NE(E)	TERMINAL BLOCK - EARTH
NE(F)	TERMINAL BLOCK - FAN
NE(N)	TERMINAL BLOCK - NEUTRAL
NE(SA)	TERMINAL BLOCK - SWITCH ACTIVE
NE(SV)	TERMINAL BLOCK - SOLENOID VALVE
NE(V)	TERMINAL BLOCK - VOLT FREE

LEGEND		WIRE SIZE
J1	POWER SUPPLY	1.0mm ²
J2	PROBE SUPPLY	2.5mm ²
J3	ANALOG INPUT	2.5mm ²
J4	DIGITAL INPUT	2.5mm ²
J5	ANALOG OUTPUT	2.5mm ²
J6	BMS CONNECTION	2.5mm ²
J7	TERMINAL CONNECTOR	2.5mm ²
J8	IPC BUS	2.5mm ²
J9	PLD TERMINAL CONNECTOR	2.5mm ²
J10	RS485 / LAN CONNECTOR	2.5mm ²
J11	VALVE 1 CONTROL OUTPUT	2.5mm ²
J12	RELAY DIGITAL OUTPUT GROUP 1	2.5mm ²
J13	RELAY DIGITAL OUTPUT GROUP 1	2.5mm ²
J14	RELAY DIGITAL OUTPUT GROUP 2	2.5mm ²
J15	RELAY DIGITAL OUTPUT GROUP 3	2.5mm ²
J16	DIGITAL INPUT	2.5mm ²
J17	VALVE 2 CONTROL OUTPUT	2.5mm ²
J18	ANALOGUE INPUT	2.5mm ²

95301600
 953016H0
 953016HS
 47011E Rev:02
 47062E Rev:02

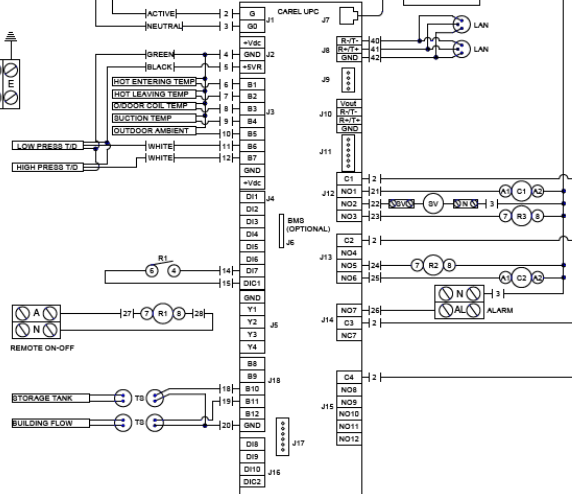

CONNECTIONS - ELECTRICAL

16KW HEAT PUMP (DUCTED) WIRING DIAGRAM -952016 MODELS

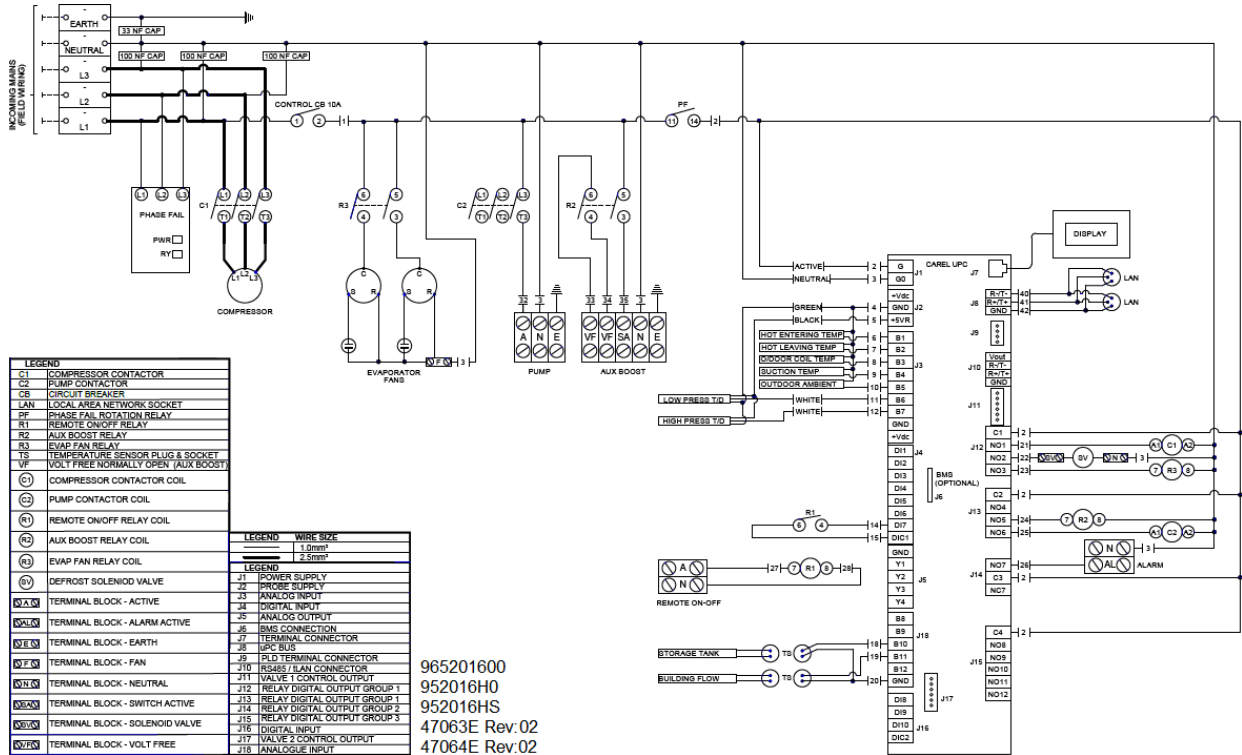

965201600
 952016H0
 952016HS
 47063E Rev:02
 47064E Rev:02

CONNECTIONS - ELECTRICAL

35KW HEAT PUMP (DUCTED & NON-DUCTED) WIRING DIAGRAM- 952035 AND 953035 MODELS

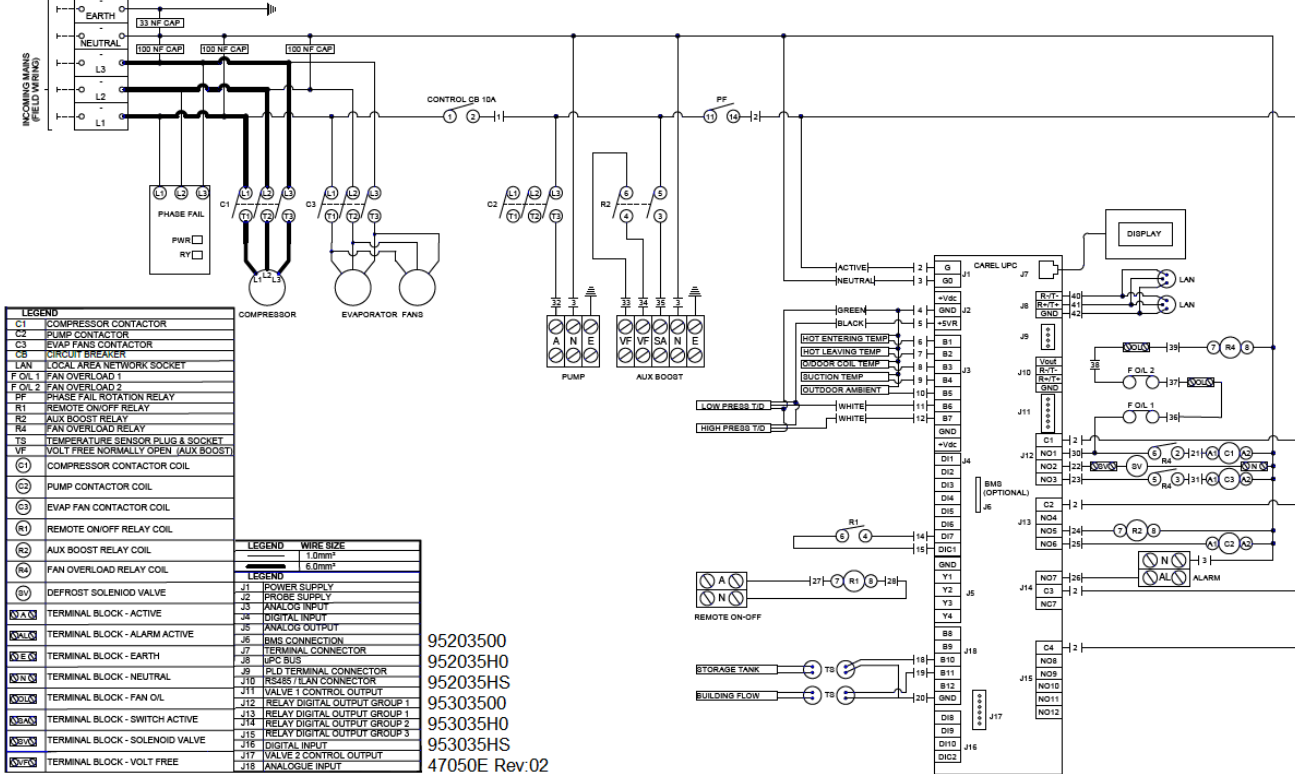

LEGEND	
C1	COMPRESSOR CONTACTOR
C2	PUMP CONTACTOR
C3	EVAP FANS CONTACTOR
CB	CIRCUIT BREAKER
LAN	LOCAL AREA NETWORK SOCKET
F.OIL 1	FAN OVERLOAD 1
F.OIL 2	FAN OVERLOAD 2
PF	PHASE FAIL ROTATION RELAY
R1	REMOTE ON/OFF RELAY
R2	AUX BOOST RELAY
R4	FAN OVERLOAD RELAY
TS	TEMPERATURE SENSOR PLUG & SOCKET
VF	VOLT FREE NORMALLY OPEN (AUX BOARD)
(C)	COMPRESSOR CONTACTOR COIL
(C)	PUMP CONTACTOR COIL
(C)	EVAP FAN CONTACTOR COIL
(R)	REMOTE ON/OFF RELAY COIL
(C)	AUX BOOST RELAY COIL
(R)	FAN OVERLOAD RELAY COIL
(V)	DEFROST SOLENOID VALVE
(N/A)	TERMINAL BLOCK - ACTIVE
(N/AL)	TERMINAL BLOCK - ALARM ACTIVE
(N/E)	TERMINAL BLOCK - EARTH
(N/N)	TERMINAL BLOCK - NEUTRAL
(N/O)	TERMINAL BLOCK - FAN OIL
(N/S)	TERMINAL BLOCK - SWITCH ACTIVE
(N/SV)	TERMINAL BLOCK - SOLENOID VALVE
(N/VF)	TERMINAL BLOCK - VOLT FREE

LEGEND WIRE SIZE	
	1.0mm ²
	6.0mm ²

LEGEND	
J1	POWER SUPPLY
J2	PROBE SUPPLY
J3	ANALOG INPUT
J4	DIGITAL INPUT
J5	ANALOG OUTPUT
J6	BMS CONNECTION
J7	TERMINAL CONNECTOR
J8	IPC BUS
J9	PLD TERMINAL CONNECTOR
J10	RS485 / I2C TERMINAL CONNECTOR
J11	VALVE 1 CONTROL OUTPUT
J12	RELAY DIGITAL OUTPUT GROUP 1
J13	RELAY DIGITAL OUTPUT GROUP 1
J14	RELAY DIGITAL OUTPUT GROUP 2
J15	RELAY DIGITAL OUTPUT GROUP 3
J16	DIGITAL INPUT
J17	VALVE 2 CONTROL OUTPUT
J18	ANALOGUE INPUT

95203500
 952035H0
 952035HS
 95303500
 953035H0
 953035HS
 47050E Rev:02

CONNECTIONS - ELECTRICAL

Controller and Display Information

UPC Parameter Hierarchy

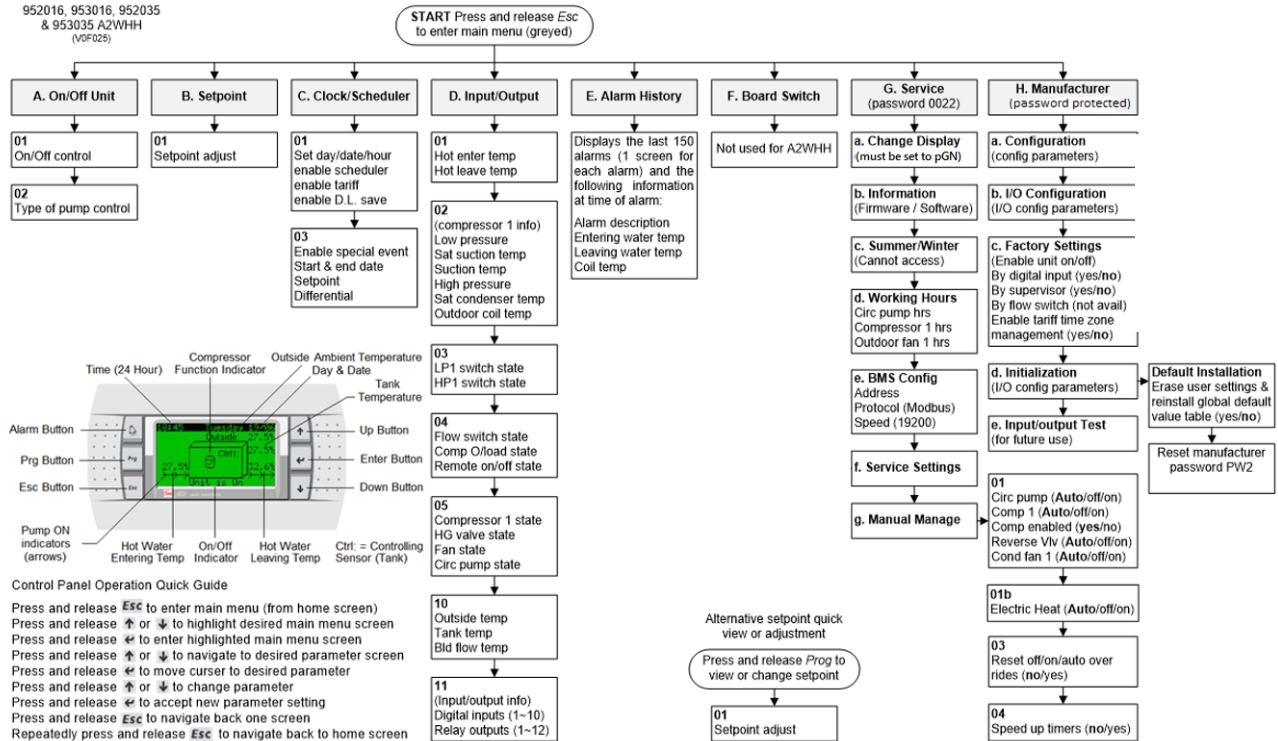

CONNECTIONS - ELECTRICAL

Note: If no keys are pressed for 60 seconds, screen reverts to main display screen and any changes made and not confirmed will be lost.

Set Point Quick Setting

Press '**prg**' from the main display screen and the Set Point page will appear. Cursor will be on the set temperature. Pressing the up and down keys will adjust the setting in 0.1 increments. Hold down for rapid change. Press '**Enter**' to confirm change. Press '**esc**' to return to the main display screen. The factory setting is 61°C. The set point can be adjusted up to 65°C depending on site suitability after consulting with Rheem.

Menu Item

- A. **On/Off** – Press '**enter**' to access change. Press '**up**' or '**down**' to turn unit on or off. Press '**enter**' to confirm.
Press '**down**' key to display type of circulating pump control.
Default: AUTOMATIC ON TEMP
Press '**esc**' to return to Menu Master.

- B. **Set Point** - displays the tank maximum set point at which the compressor will be deactivated. Cursor will be on the set temperature. Pressing the '**up**' and '**down**' keys will adjust the setting in 0.1 increments. Hold down for rapid change. Press '**enter**' to confirm change. Press '**esc**' to return to the Menu Master.

- C. **Clock / Scheduler** – time and date are set here. Other adjustments include:
 - i. **Enable Scheduler:** No (controls heat pump operating time based on programmed time period)
 - ii. **Enable Tariff:** No (controls heat pump operating time based on tariffs)
 - iii. **Enable D.L. Save:** No (shifts time based on seasons)

CONNECTIONS - ELECTRICAL

- i. **Enabling Scheduler** to 'Yes' will open a 2nd page which will allow the user to program specified operating times on a 7-day basis.
E.g.:

Clock Schedule

Mon 00:00 to 00:00

Tue 00:00 to 00:00

Pressing the '**down**' key will reveal a 2nd page in the Clock Scheduler:

- Do you want to enable Special Event: No
(programs the temperature to be maintained during a specified date range)

Enabling the Special Event to 'Yes' allows user to program in the desired date range, set point and differential to be maintained during the Special Event period.

- ii. **Enabling Tariff** to Yes will open the Tariff Time Band pages which allows the user to program which hours are off peak, shoulder and peak in 12 hour blocks as Weekday AM, Weekday PM, Weekend AM, Weekend PM.

A third page allows the user to load the default for NSW or QLD or Custom.

Press '**esc**' until page returns to the Menu Master.

CONNECTIONS - ELECTRICAL

D. **Input/output View** – Displays the actual readings as follows:

Hot Enter Temp:	Potable water temperature entering and leaving the condenser heat exchanger (A2W and W2W heat pumps)
Hot Leave Temp:	
Cold enter Temp:	Non-potable/chilled water temperature entering and leaving the evaporator heat exchanger (W2W heat pump)
Cold Leave Temp:	
Compressor 1 – Low Press:	Compressor temperature and pressure readings
sat. suction:	
Suction:	
High Press:	
sat. condenser:	
out. coil Temp:	Evaporator coil temperature (A2W heat pump)
LP1 switch: OK	Hi and Lo pressure switches closed or open circuit
HP1 switch: OK	
Flow switch: On/Off	Flow switch in non-potable/chilled water circuit activated (W2W heat pump)
Comp O/Load: On/Off	Compressor overload activated
Remote: On/Off	Remote control of heat pump activated
Compressor 1: On/Off	Compressor status
Rev. valve: On/Off	Reversing valve status (NA)
Fan: On/Off	Fan status (A2W heat pump)
Circ. Pump: On/Off	Primary pump/s status (NB: both non-potable/chilled and potable water pumps are activated by same relay in W2W heat pump)
Outside Temp:	Ambient air sensor temperature (A2W heat pump)
Tank Temp:	Temperature at near bottom of tank
Building Flow Temp:	Temperature being delivered to building flow
Digital Inputs:	Displays the number of inputs and outputs
Relay Outputs:	

CONNECTIONS - ELECTRICAL

E. **Alarm History** – will display up to 150 alarm events and then will overwrite oldest event. Alarms can be cleared by pressing the '**Alarm Bell**' key.

F. **Service** – password: 0022

- a. Change display (do not use)
- b. Information – software version information
- c. Summer/Winter (not applicable to this product)
- d. Working Hours:
 - i. Circ. Pump / reset counter
 - ii. Compressor 1 / reset counter
 - iii. Outdoor Fan 1 / reset counter
- e. BMS configuration (will time out after 5 minutes if no buttons pressed)

Address: 1 (if BMS Interface Card Modbus on RS485 is used, change the address value based on the unique address set by the customer's network. For all other BMS interface cards, ignore this value)

Protocol: CAREL/Modbus (choose Modbus only for BMS Interface Card Modbus on RS485. For all other BMS interface cards, choose CAREL)

Speed: 19200 (if BMS Interface Card Modbus on RS485 is used, change the speed value based on the customer's network. For all other BMS interface cards, use 19200 as speed)

CONNECTIONS - ELECTRICAL

- f. Service Settings
 - a. Working Hour Set
 - b. Prove Adjustment
 - c. Thermoregulation (for multiple heat pump installation, change the no. of compressor and other settings from here.)

	Parameter	Sub Parameter	Master	Slave
c. Thermoregulation	Thermoregulation 01	Setpoint	60.0°C	Screen N/A
		Differential	3.0°C	Screen N/A
		Dead band	0.5°C	Screen N/A
	Thermoregulation 02 (De-ice temperature)	Initiate	-4°C	-4°C
		Terminate	10.0°C	10.0°C
	Thermoregulation 03 (De-ice timers)	Delay to start	5m	5m
		Max duration	10m	10m
		Min between	30m	30m
		Coil de-water	30s	30s
	Thermoregulation 04 (Pump settings)	Flow proof delay	3s	Screen N/A
		Pump min run	5m	Screen N/A
		Pump run on time	1m	Screen N/A
		Temp. test cycle	Not avail	Screen N/A
		Flow switch fitted	No	Screen N/A
	Thermoregulation 04s	Flow switch fitted	Screen N/A	No
	Thermoregulation 05	Blackout delay	10s	Screen N/A
		No of compressors (number of heat pumps)	Set as required (default 1)	Screen N/A
		Compressor staging	Simultaneous	Screen N/A
		Controlling sensor	Tank	Screen N/A
	I/O Config 05	Out air sensor	Yes	No
		Sensor type	Carel NTC	Carel NTC
	Thermoregulation 06 (Enable unit On/Off)	By digital input	No	Screen N/A
		By supervisor	No	Screen N/A
		By flow switch	Not avail	Screen N/A
		Dig input 6 is for:	Comp O/Load	Screen N/A
	I/O Config 06b	Storage tank temp	Yes	No
		Sensor type	Carel NTC	Carel NTC
		Building flow temp	Yes	No
		Sensor type	Carel NTC	Carel NTC
	Thermoregulation 07 (HP/LP Safety)	LP trip set	0.4 Bar	0.4 Bar
HP trip set		27.5 Bar	27.5 Bar	
Thermoregulation 08 (Anti-freeze safety for PHE evaporator (leave))	Low limit set	0.0°C	Screen N/A	
Thermoregulation 09	Aux. Boost Fitted	Yes	Screen N/A	
	% compressor in alarm to activate boost	50%	Screen N/A	
	Boost act. Delay	5m	Screen N/A	
Thermoregulation 10 (Low outside air temp i.e low ambient aux boost)	Cut over point	5.0°C	Screen N/A	
	Differential	2.0°C	Screen N/A	
	Comp stop in low outside air temp:	No	Screen N/A	

d. User DEV/Change PW1

For more information, please refer to the service manual for heat pumps.

COMMISSIONING

To Fill And Turn On The Water Heater

The power supply to the water heater and controller must not be switched on until the water heater is filled with water and a satisfactory megger reading is obtained.

⚠ Warning: This water heater contains electronic equipment and 500 V insulation tests must only be conducted between actives and earth and between neutral and earth. An active to neutral test WILL damage the electronics.

Commissioning Procedure – Standalone Heat Pump Configuration

- Perform this procedure to commission a single (standalone) heat pump.
- If the system is comprised of multiple standalone heat pumps, perform this procedure for each heat pump.

- Open all of the hot water taps in the building (don't forget the showers) and supply cocks and valves in the system.
- Open the isolation valves fully on the cold, return and hot water branches to the storage tanks.
- Open the main cold water isolation valve.
- Air will be forced out of the taps.
- Close each tap as water flows freely from it.
- Check the pipe work for leaks.
- Switch on the electrical supply at the isolating switch to the water heater.
- Set time/tariff control if required.
- Reset alarms. Skip this step if there are no alarms.

If the water heater is full of cold water, the fan will activate and heating will commence unless the ambient air temperature is below the ambient sensor set point, in which case the auxiliary boost will operate, if installed.

It is important to wait for five minutes after the heat pump has activated to ensure it continues to operate and is functioning correctly.

Note: The water heater may not turn on immediately when it is first switched on, if it is switched on within 20 minutes to 2 hours of it having been switched off at the isolating switch, or the heat pump has just completed a heating cycle. The water heater will wait until the conditions for start-up are favourable in order to protect the compressor from damage. This may take up to 20 minutes to 2 hours. The auxiliary booster (if installed) will operate instead of the heat pump if the ambient air temperature is less than the ambient sensor set point.

Explain to a responsible officer the functions and operation of the heat pump water heater. Upon completion of the installation and commissioning of the water heating system, leave this guide with the responsible officer.

Commissioning Procedure – Multiple Heat Pump (Master/Slave) Configuration

Perform this procedure if the system is comprised of multiple heat pumps to be configured for Master/Slave operation.

- Open all of the hot water taps in the building (don't forget the showers) and supply cocks and valves in the system.
- Open the isolation valves fully on the cold, return and hot water branches to the storage tanks.
- Open the main cold water isolation valve on the cold water line to the storage tanks.

Air will be forced out of the taps.

- Close each tap as water flows freely from it.
- Check the pipe work for leaks.

Before commencing the Master/Slave commissioning procedure, ensure the **'Multiple Heat Pump Installation**

- step 1 and step 2 have been completed as stated on **page 53**.

The commissioning procedure **MUST** be performed in the order shown.

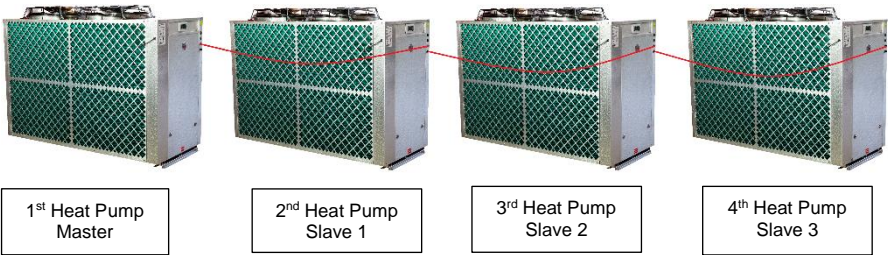

1. Ensure all heat pumps are turned OFF at the isolating switch.
2. Turn ON slave 1 heat pump (2nd heat pump).
3. Configure heat pump address.
 - Whilst in the home screen on control panel, simultaneously press and hold Up , Down and Enter for 5 seconds to enter the setup menu.
 - Use Up or Down buttons to set values.
 - Press and release Enter to move cursor to next line.
 - Change the following values as shown below.

Menu	Slave 1	Slave 2	Slave 3	Master	Example Screen Image of Slave 1
Display address setting	17	18	19	16	
I/O board address	02	03	04	01	
trm1	32	32	32	32	
trm2	17	18	19	16	
trm3 None - Ok?	Yes	Yes	Yes	Yes	

- Press “Enter” to confirm settings. The screen will change to the home screen and settings will be saved.

Note that the slave's pump will start and an alarm may occur – ignore at this stage.

4. Change slave heat pump 'Out air sensor', 'Storage tank temp' sensor and 'Building flow temp' sensor parameters to 'No'.
 - Go to the Service menu (Service>Service Settings- password 0022>Thermoregulation). Refer to [page 59](#) to see the chart for navigating Service menu and [page 64](#) for Thermoregulation section or see the table below.

Parameter	Sub Parameter	Master	Slave
Thermoregulation 05	Blackout delay	10s	Screen N/A
	No of compressors	Set as required (default 1)	Screen N/A
	Compressor staging	Simultaneous	Screen N/A
	Controlling sensor	Tank	Screen N/A
I/O Config 05	Out air sensor	Yes	No
	Sensor type	Carel NTC	Carel NTC
Thermoregulation 06 (Enable unit On/Off)	By digital input	No	Screen N/A
	By supervisor	No	Screen N/A
	By flow switch	Not avail	Screen N/A
	Dig input 6 is for:	Comp O/Load	Screen N/A
I/O Config 06b	Storage tank temp	Yes	No
	Sensor type	Carel NTC	Carel NTC
	Building flow temp	Yes	No

5. Turn OFF the Slave heat pump.
 - If there is only 1 slave proceed directly to step 6.
 - If there are 2 or 3 Slave heat pumps repeat step 3 to step 5 for Slave 2 and Slave 3 respectively using the values for respective Slave heat pumps.
6. Turn ON Master heat pump and set the master address as stated in step 3.
7. After commissioning the Master heat pump, go to the Service menu (Service>Service Settings- password 0022>Thermoregulation>no. of compressor) on the Master heat pump and change the number of compressors according to the number of heat pumps interconnected together.



Refer to [page 59](#) to see the chart for navigating Service menu and [page 64](#) for Thermoregulation section or see the table below.

Parameter	Sub Parameter	Master
Thermoregulation 05	Blackout delay	10s
	No of compressors (Number of heat pumps)	Set as required (default 1)
	Compressor staging	Simultaneous
	Controlling sensor	Tank

8. Turn on all the heat pumps.
9. Reset alarms on each heat pump. Skip this step if there are no alarms.
10. Set time/tariff control on Master heat pump if required. Refer to [page 59](#) to see the chart for navigating the control panel display.

If the water heaters are full of cold water, the fan will activate on each water heater and heating will commence unless the ambient air temperature is below the ambient sensor set point, in which case the auxiliary boost will operate, if installed.

It is important to wait for five minutes after each heat pump has activated to ensure it continues to operate and is functioning correctly.

Note: The heat pump may not turn on immediately when it is first switched on, if it is switched on within 20 minutes to 2 hours of it having been switched off at the isolating switch, or the heat pump has just completed a heating cycle. The heat pump will wait until the conditions for start-up are favourable in order to protect the compressor from damage. This may take up to 20 minutes to 2 hours. The auxiliary booster (if installed) will operate instead of the heat pump if the ambient air temperature is less than the ambient sensor set point.

Explain to a responsible officer the functions and operation of the heat pumps. Upon completion of the installation and commissioning of the water heating system, leave this guide with the responsible officer.

Commissioning Procedure- BMS Configuration

Before commencing the commissioning procedure, ensure the '**Building Management Systems (BMS/BAS)**' installation procedure has been completed as stated on [page 55](#).

- If the system is comprised of single or multiple standalone heat pumps, perform this procedure for each heat pump. Each heat pump will have its own BMS card.
- If the system is comprised of multiple heat pumps for Master/Slave operation, perform this procedure for only master heat pump. Only master heat pump will have a BMS card and the slave heat pumps will be connected via LAN cable.

Configure BMS settings from the display of the heat pump.

After commissioning the Master heat pump, go to the Service menu (Service- password 0022>BMS config). Refer to [page 59](#) to see the chart for navigating Service menu.

Configuration: BMS Interface Card Modbus on RS485

1. Go to BMS configuration (will time out after 5 minutes if no buttons pressed)

Change the settings for BMS configuration from the display menu as mentioned below.

Address: Change the address value based on the unique address set by the customer's network.

Protocol: Choose option 'Modbus'

Speed: Change the speed value based on the customer's network.

2. Parameter table is provide for customers to follow for further configuration to customer's network on [page 73](#).

Configuration: BMS Interface card BACnet MS-TP

1. Go to BMS configuration (will time out after 5 minutes if no buttons pressed)

Change the settings for BMS configuration from the display menu as mentioned below.

Address: No change required (address is irrelevant for this card).

Protocol: CAREL

Speed: 19200 (this value is set from factory to communicate between heat pump and BMS card)

2. Open the heat pump enclosure and check the BMS card.

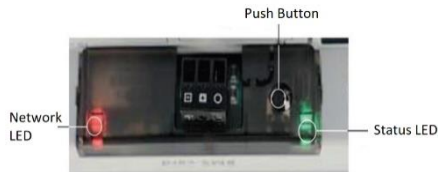

The BACnet MS-TP card features a button (PUSHBUTTON) and two indicator lights (STATUS LED and NETWORK LED).

Functions of the button: When starting up the BACnet MS-TP, this is used to select, for network communication, whether to use the factory parameters or the user parameters

In normal operation, reboots BACnet MS-TP without needing to disconnect the power supply

Status LED: indicates the status of communication with the heat pump and the card. Once the starting sequence has been completed, the Status LED flashes to indicate the quality of communication.

- a. If Status LED flashes green, then communication with the BACnet MS-TP is OK.
- b. If LED is red or green-red-green, then the communication is not established. In that case, check the BMS configuration.

Network LED: The Network LED (right) indicates the status of communication with customer's network. Once the starting sequence has been completed, the Network LED flashes to indicate the quality of communication with customer's network.

- a. If Network LED flashes green with occasional red flashes then communication is OK.
- b. If Network LED flashes green and red ON together (BACnet MS/TP meaning: continuous Poll-For-Master): communication not established (connection problems, or no network device found); this may depend on electrical connection difficulties or communication settings that are not compatible with the other network devices connected.

3. For further configuration of BACnet MS-TP card, please follow the "BACnet MS-TP Configuration Guide".
4. Parameter table is provided for customers to follow for further configuration to customer's network on **page 73**.

Configuration: BMS Interface card BACnet TCP/IP Ethernet

1. Go to BMS configuration (will time out after 5 minutes if no buttons pressed)

Change the settings for BMS configuration from the display menu as mentioned below.

Address: No change required (address is irrelevant for this card).

Protocol: CAREL

Speed: 19200 (this value is set from factory to communicate between heat pump and BMS card)

2. Open the heat pump enclosure and check the BMS card.

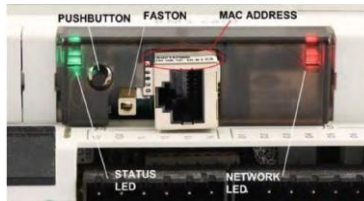

The BACnet TCP/IP Ethernet card features a button (PUSHBUTTON) and two indicator lights (STATUS LED and NETWORK LED).

Functions of the button: When starting up the TCP/IP Ethernet card, this is used to select, for network communication, whether to use the factory parameters or the user parameters. In normal operation, reboots TCP/IP Ethernet card without needing to disconnect the power supply.

Status LED: indicates the status of communication with the heat pump and the card. Once the starting sequence has been completed, the Status LED flashes to indicate the quality of communication.

- a. If Status LED flashes green or green steady, then communication with the BACnet TCP/IP Ethernet card is OK.
- b. If LED is red or green-red-green, then the communication is not established. In that case, check the BMS configuration.

Network LED: Displays the status of the physical network connection (Ethernet connection signals), regardless of whether the network parameters are correct; usually this must be green and flash when data is transmitted/received.

3. For further configuration of BACnet TCP/IP Ethernet card, please follow the "BACnet TCP/IP Ethernet Configuration Guide".
4. Parameter table is provided for customers to follow for further configuration to customer's network on **page 73**.

Refer to the parameter tables below for BMS:

Analog variables

BMS Address	Description	Default	Category	UOM	Min	Max	Read/Write	Variable name
1	reading from input 1 Hot Entering water Sensor	0	Default	---	-3276.8	3276.7	R	Probe_Value_1
2	reading from input 2 Hot Leaving water Sensor	0	Default	---	-3276.8	3276.7	R	Probe_Value_2
3	reading from input 3 Out. coil sensor	0	Default	---	-3276.8	3276.7	R	Probe_Value_3
4	reading from input 4 Suction Temperature sensor	0	Default	---	-3276.8	3276.7	R	Probe_Value_4
5	reading from input 5 Out Air sensor	0	Default	---	-3276.8	3276.7	R	Probe_Value_5
6	reading from input 6 LP Pressure sensor fitted	0	Default	---	-3276.8	3276.7	R	Probe_Value_6
7	reading from input 7 HP Pressure sensor fitted	0	Default	---	-3276.8	3276.7	R	Probe_Value_7
8	reading from input 8 Cold Enter water	0	Default	---	-3276.8	3276.7	R	Probe_Value_8
9	reading from input 9 Cold Leave water	0	Default	---	-3276.8	3276.7	R	Probe_Value_9
10	reading from input 10 Hot Entering water Sensor	0	Default	---	-3276.8	3276.7	R	Probe_Value_10
11	reading from input 11 Hot Leaving water Sensor	0	Default	---	-3276.8	3276.7	R	Probe_Value_11
12	reading from input 12 Out. coil sensor	0	Default	---	-3276.8	3276.7	R	Probe_Value_12
13	Virtual Analoge Output 1	0	Default	---	0	3276.7	R	VAOut_1
14	Virtual Analoge Output 2	0	Default	---	0	3276.7	R	VAOut_2
15	Virtual Analoge Output 3	0	Default	---	0	3276.7	R	VAOut_3
16	Virtual Analoge Output 4	0	Default	---	0	3276.7	R	VAOut_4
17	Virtual Analoge Output 5	0	Default	---	0	3276.7	R	VAOut_5
18	Virtual Analoge Output 6	0	Default	---	0	3276.7	R	VAOut_6
19	Superheat valve Comp 1	0	Default	---	-72.0	324.0	R	Superheat_C1
20	Superheat valve Comp 2	0	Default	---	-72.0	324.0	R	Superheat_C2
21	Superheat valve Comp 3	0	Default	---	-72.0	324.0	R	Superheat_C3
22	Superheat valve Comp 4	0	Default	---	-72.0	324.0	R	Superheat_C4

23	Control Temperature	0	Default	°C	-99.9	99.9	R	Ctrl_temp
24	Outside Air Temperature	0	Default	BAR	-99.9	99.9	R	OAT
25	Entering water temperature	0	Default	°C	-99.9	99.9	R	EW_temp
26	Leaving water temperature	0	Default	°C	-99.9	99.9	R	LW_temp
27	Condenser temperature (either from NTC or P-T)	0	Default	---	-99.9	99.9	R	Cond_temp
28	Current entering water Setpoint	22.0	Default	°C	0	45.0	R	Active_Setpoint
29	Active Proportional Band for compressor	1.5	Default	°C	0	9.9	R	Active_Pro_band
BMS Address	Description	Default	Category	UOM	Min	Max	Read/Write	Variable name
30	Water Setpoint	22.0	Default	°C	5.0	45.0	R/W	Setpoint
31	Dead band	1.0	Default	°C	0	9.9	R/W	D_Band
32	Proportional Band for compressor	1.5	Default	°C	0	25.0	R/W	Pro_band
33	Entering water temperature 2	0	Default	°C	-99.9	99.9	R	EW_temp2
34	Leaving water temperature 2	0	Default	°C	-99.9	99.9	R	LW_temp2
35	Storage tank water temperature	0	Default	°C	-99.9	99.9	R	Tank_temp
36	Building Supply water temperature (Flow)	0	Default	°C	-99.9	99.9	R	Bld_Supply_temp

Integer variables

BMS Address	Description	Default	Category	UOM	Min	Max	Direction	Variable name
21	type of tariff - timeband 0 week end	0	Default	---	0	2	R/W	trfw_0
22	type of tariff - timeband 1 week end	0	Default	---	0	2	R/W	trfw_1
23	type of tariff - timeband 2 week end	0	Default	---	0	2	R/W	trfw_2
24	type of tariff - timeband 3 week end	0	Default	---	0	2	R/W	trfw_3
25	type of tariff - timeband 4 week end	0	Default	---	0	2	R/W	trfw_4
26	type of tariff - timeband 5 week end	0	Default	---	0	2	R/W	trfw_5
27	type of tariff - timeband 6 week end	0	Default	---	0	2	R/W	trfw_6
28	type of tariff - timeband 7 week end	0	Default	---	0	2	R/W	trfw_7
29	type of tariff - timeband 8 week end	0	Default	---	0	2	R/W	trfw_8
30	type of tariff - timeband 9	0	Default	---	0	2	R/W	trfw_9
31	type of tariff - timeband 10 week end	0	Default	---	0	2	R/W	trfw_10
32	type of tariff - timeband 11 week	0	Default	---	0	2	R/W	trfw_11

	end							
33	type of tariff - timeband 12 week end	0	Default	---	0	2	R/W	trfw_12
34	type of tariff - timeband 13 week end	0	Default	---	0	2	R/W	trfw_13
35	type of tariff - timeband 14 week end	0	Default	---	0	2	R/W	trfw_14
36	type of tariff - timeband 15 week end	0	Default	---	0	2	R/W	trfw_15
37	type of tariff - timeband 16 week end	0	Default	---	0	2	R/W	trfw_16
38	type of tariff - timeband 17 week end	0	Default	---	0	2	R/W	trfw_17
BMS Address	Description	Default	Category	UOM	Min	Max	Direction	Variable name
39	type of tariff - timeband 18 week end	0	Default	---	0	2	R/W	trfw_18
40	type of tariff - timeband 19 week end	0	Default	---	0	2	R/W	trfw_19
41	type of tariff - timeband 20 week end	0	Default	---	0	2	R/W	trfw_20
42	type of tariff - timeband 21 week end	0	Default	---	0	2	R/W	trfw_21
43	type of tariff - timeband 22 week end	0	Default	---	0	2	R/W	trfw_22
44	type of tariff - timeband 23 week end	0	Default	---	0	2	R/W	trfw_23
49	State of unit. Meaning of Status: 0 - waiting (at power up) 1 - Unit On 2 - Unit OFF by Alarm 3 - Unit OFF by Flow Switch 4 - Unit OFF by BMS 5 - Unit OFF by Scheduler (timelock) 6 - Unit OFF by Digital Input 7 - Unit OFF by Keyboard (Service mode) 8, 9, 10, 11, 12, 13 not used	0	Default	---	0	13	R	Unit_Status
70	Compressor 1 Hour run counter (low)	0	Default	---	0	999	R	Comp_T_Hours_L_1
71	Compressor 1 Hour run counter (high)	0	Default	---	0	999	R	Comp_T_Hours_H_1
72	Compressor 2 Hour run counter (low)	0	Default	---	0	999	R	Comp_T_Hours_L_2
73	Compressor 2 Hour run counter (high)	0	Default	---	0	999	R	Comp_T_Hours_H_2
74	Compressor 3 Hour run counter (low)	0	Default	---	0	999	R	Comp_T_Hours_L_3
75	Compressor 3 Hour run counter (high)	0	Default	---	0	999	R	Comp_T_Hours_H_3

76	Compressor 4 Hour run counter (low)	0	Default	---	0	999	R	Comp_T_Hours_L_4
77	Compressor 4 Hour run counter (high)	0	Default	---	0	999	R	Comp_T_Hours_H_4
78	Pump Hour run counter (low)	0	Default	---	0	999	R	Pump_T_Hours_L
79	Pump Hour run counter (high)	0	Default	---	0	999	R	Pump_T_Hours_H
86	Outdoor Fan 1 Hour run counter (low)	0	Default	---	0	999	R	OutFan_T_Hours_L_1
87	Outdoor fan 1 Hour run counter (high)	0	Default	---	0	999	R	OutFan_T_Hours_H_1
88	Outdoor Fan 2 Hour run counter (low)	0	Default	---	0	999	R	OutFan_T_Hours_L_2
89	Outdoor fan 2 Hour run counter (high)	0	Default	---	0	999	R	OutFan_T_Hours_H_2
90	Outdoor Fan 3 Hour run counter (low)	0	Default	---	0	999	R	OutFan_T_Hours_L_3
91	Outdoor fan 3 Hour run counter (high)	0	Default	---	0	999	R	OutFan_T_Hours_H_3
92	Outdoor Fan 4 Hour run counter (low)	0	Default	---	0	999	R	OutFan_T_Hours_L_4
93	Outdoor fan 4 Hour run counter (high)	0	Default	---	0	999	R	OutFan_T_Hours_H_4
100		15018	Default	---	0	32767	R	BMS_Sw_Ver
101		15018	Default	---	0	32767	R	BMS_Sw_Date
BMS Address	Description	Default	Category	UOM	Min	Max	Direction	Variable name
102		0	Default	---	0	9999	R	Manuf_Password
103	Current year	0	Clock / TimeDate	---	0	99	R	CURRENT_YEAR
104	Current month	1	Clock / TimeDate	---	1	12	R	CURRENT_MONTH
105	Current day	1	Clock / TimeDate	---	1	31	R	CURRENT_DAY
106	Current hour	0	Clock / TimeDate	h	0	23	R	CURRENT_HOUR
107	Current minute	0	Clock / TimeDate	---	0	59	R	CURRENT_MINUTE

Digital variables

BMS Address	Description	Default	Category	UOM	Min	Max	Direction	Variable name
1	Digital Input 1	0	Default	---	0	1	R	Din_1
2	Digital Input 2	0	Default	---	0	1	R	Din_2

3	Digital Input 3	0	Default	---	0	1	R	Din_3
4	Digital Input 4	0	Default	---	0	1	R	Din_4
5	Digital Input 5	0	Default	---	0	1	R	Din_5
6	Digital Input 6	0	Default	---	0	1	R	Din_6
7	Digital Input 7	0	Default	---	0	1	R	Din_7
8	Digital Input 8	0	Default	---	0	1	R	Din_8
9	Digital Input 9	0	Default	---	0	1	R	Din_9
10	Digital Input 10	0	Default	---	0	1	R	Din_10
11	Digital Input 11	0	Default	---	0	1	R	Din_11
12	Digital Input 12	0	Default	---	0	1	R	Din_12
13	Digital Input 13	0	Default	---	0	1	R	Din_13
14	Digital Input 14	0	Default	---	0	1	R	Din_14
15	Digital Input 15	0	Default	---	0	1	R	Din_15
16	Digital Input 16	0	Default	---	0	1	R	Din_16
17	Digital Input 17	0	Default	---	0	1	R	Din_17
18	Digital Input 18	0	Default	---	0	1	R	Din_18
BMS Address	Description	Default	Category	UOM	Min	Max	Direction	Variable name
19	Virtual Digital Output 1	0	Default	---	0	1	R	VDOOut_1
20	Virtual Digital Output 2	0	Default	---	0	1	R	VDOOut_2
21	Virtual Digital Output 3	0	Default	---	0	1	R	VDOOut_3
22	Virtual Digital Output 4	0	Default	---	0	1	R	VDOOut_4
23	Virtual Digital Output 5	0	Default	---	0	1	R	VDOOut_5
24	Virtual Digital Output 6	0	Default	---	0	1	R	VDOOut_6
25	Virtual Digital Output 7	0	Default	---	0	1	R	VDOOut_7
26	Virtual Digital Output 8	0	Default	---	0	1	R	VDOOut_8
27	Virtual Digital Output 9	0	Default	---	0	1	R	VDOOut_9
28	Virtual Digital Output 10	0	Default	---	0	1	R	VDOOut_10
29	Virtual Digital Output 11	0	Default	---	0	1	R	VDOOut_11
30	Virtual Digital Output 12	0	Default	---	0	1	R	VDOOut_12
31	Virtual Digital Output 13	0	Default	---	0	1	R	VDOOut_13
32	Select if din 6 is Compressor Overload or DRED	0	Default	---	0	1	R/W	Sel_dred_ol
35	remote / maintenance enable of compressor 1	1	Default	---	0	1	R/W	Comp1_En
36	remote / maintenance enable of	1	Default	---	0	1	R/W	Comp2_En

	compressor 2							
37	remote / maintenance enable of compressor 3	1	Default	---	0	1	R/W	Comp3_En
38	remote / maintenance enable of compressor 4	1	Default	---	0	1	R/W	Comp4_En
41	Actual status of compressor 1	0	Default	---	0	1	R	Device_Status_Comp_1
42	Actual status of compressor 2	0	Default	---	0	1	R	Device_Status_Comp_2
43	Actual status of compressor 3	0	Default	---	0	1	R	Device_Status_Comp_3
44	Actual status of compressor 4	0	Default	---	0	1	R	Device_Status_Comp_4
45	Actual status of reverse valve	0	Default	---	0	1	R	Device_Status_rev_vlv1
46	Actual status of reverse valve 2	0	Default	---	0	1	R	Device_Status_rev_vlv2
47	Actual status of reverse valve 3	0	Default	---	0	1	R	Device_Status_rev_vlv3
48	Actual status of reverse valve	0	Default	---	0	1	R	Device_Status_rev_vlv4
49	On-Off unit state (0: Off; 1: On)	0	Default	---	0	1	R	Sys_On
50	Supervisor (BMS) On-Off. Show the state OFFbyBMS in main mask (0: Off; 1: On)	0	Default	---	0	1	R/W	Superv_OnOff
51	Alarm reset from supervisory	1	Default	---	0	1	R/W	RST_Alarms
BMS Address	Description	Default	Category	UOM	Min	Max	Direction	Variable name
52	Enable tariff time zone management	0	Default	---	0	1	R/W	Trf_en
120	Alarm relay	0	Default	---	0	1	R	Alarm
121	Alarm from probe on input 1	0	Alarms	---	0	1	R	AI_probe_1
122	Alarm from probe on input 2	0	Alarms	---	0	1	R	AI_probe_2
123	Alarm from probe on input 3	0	Alarms	---	0	1	R	AI_probe_3
124	Alarm from probe on input 4	0	Alarms	---	0	1	R	AI_probe_4
125	Alarm from probe on input 5	0	Alarms	---	0	1	R	AI_probe_5
126	Alarm from probe on input 6	0	Alarms	---	0	1	R	AI_probe_6
127	Alarm from probe on input 7	0	Alarms	---	0	1	R	AI_probe_7
128	Alarm from probe on input 8	0	Alarms	---	0	1	R	AI_probe_8
129	Alarm from probe on input 9	0	Alarms	---	0	1	R	AI_probe_9
130	Alarm from probe on input 10	0	Alarms	---	0	1	R	AI_probe_10
131	Alarm from probe on input 11	0	Alarms	---	0	1	R	AI_probe_11
132	Alarm from probe on input 12	0	Alarms	---	0	1	R	AI_probe_12
133	Alarm_comp1	0	Default	---	0	1	R	Device_Alarm_comp1
134	Alarm_comp2	0	Default	---	0	1	R	Device_Alarm_comp2
135	Alarm_comp3	0	Default	---	0	1	R	Device_Alarm_comp3
136	Alarm_comp4	0	Default	---	0	1	R	Device_Alarm_comp4

137	Compressor Overload 1	0	Default	---	0	1	R	Comp_OL1
138	Compressor Overload 2	0	Default	---	0	1	R	Comp_OL2
139	Compressor Overload 3	0	Default	---	0	1	R	Comp_OL3
140	Compressor Overload 4	0	Default	---	0	1	R	Comp_OL4

To Turn Off The Water Heater

If it is necessary to turn off the water heater on completion of the installation, such as on a building site or where the premises are vacant, then:

- Switch off the electrical supply at the isolating switch to the water heater.
- Close the cold water isolation valve at the inlet to the system.

DRAINING THE WATER HEATER

To drain the water heater:

- Turn off the water heater (refer to [“To Turn Off The Water Heater”](#) on **page 68**).
- Close all hot water taps.
- Operate the relief valve release lever on one of the storage tanks - do not let the lever snap back or you will damage the valve seat.

Operating the lever will release the pressure in the water heater.

- Close the isolation valves at the inlet and outlet of the water heater and place a bucket under the cold water inlet.
- Undo the unions at the inlet and outlet of the water heater. The heat pump heat exchanger holds 5 to 10 litres of water (model dependent) and will drain into the bucket.

TROUBLE SHOOTING

- **Heat Pump Won't Start**

A delay of up to 20 minutes to 2 hours can be experienced before heat pump starts operating

- **Incorrect Phase Rotation**



PHASE
DETECT
RELAY



The phase detect relay will open circuit if the heat pump has been wired with incorrect phase rotation or if a phase has failed. Both green and yellow LEDs on the relay will be illuminated if phase rotation is correct.

- **Alarm light on heat pump controller**

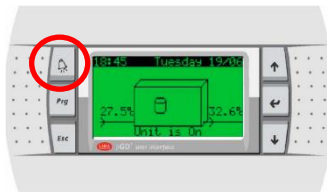

If the alarm light is flashing RED, check the alarm by pressing the alarm button. Phone your nearest Rheem Service Department or Accredited Service Agent (or Service Centre in NZ) to inform about the alarm.

- **Low Ambient Temperature**

If the ambient air temperature is below set point, the heat pump may not start. Check the control panel of the heat pump. Check outside ambient temperature that shows on the display.

- **Heat pump starts then turns off soon after**

This could be caused by:

- a. Insufficient water flow rate through heat exchanger. Check pipe sizing per chart, check obstructions, check lines and pump are bled, check pump is operating, check temperature rise across inlet and outlet.

Note: Tanks and heat pumps are to be manifolded in Equa-Flow. It is important that the branches to each storage tank **ONLY** contain a gate or ball valve and union. Fitting of loose jumper valves, non-return valves or pressure limiting valves in the branches or primary flow and return lines between the heat pump and tanks **WILL** affect performance of the heat pump.

- b. Refrigerant charge too high? Refer to Alarm.
- c. Refrigerant charge too low? Refer to Alarm.

Turn heat pump off then on again at isolating switch to reset system.

- **Heat pump compressor excessively noisy**

Check for correct phase rotation (refer to [page 81](#)).

AUTOMATIC DEFROST

The Rheem Commercial Heat Pump installation can be configured in a number of ways depending on the requirements of the individual installation.

Ice may begin to form on the evaporator when the air temperature falls below 7°C, and this will reduce the heat pump efficiency. The water heating system can be designed to operate in one of two scenarios in low ambient temperature conditions.

When auxiliary heating mode is OFF, the heat pump will use hot gas bypass to melt any ice that may form on the evaporator coil when operating at air temperatures below 5°C and there will be no auxiliary boost.

When auxiliary heating mode is ON, the heat pump will use hot gas bypass to melt any ice that may form on the evaporator coil when operating at air temperatures below 5°C and auxiliary gas or electric water heater will be activated. A pump circulates water from the storage tanks through the auxiliary water heater until the set temperature is reached.

The auxiliary heater should be set to 60°C.

For most applications, automatic defrost should be satisfactory to meet the water heating demands.

The water heater can control an auxiliary heating source if the ambient temperature falls below 5°C or if 50% or more of the water heaters are in fault mode.

This page is left blank intentionally

This page is left blank intentionally

RHEEM HEAT PUMP WATER HEATER WARRANTY

- AUSTRALIA & NEW ZEALAND ONLY -

HEAT PUMP WATER HEATER MODELS 95301600, 95201600, 953016H0, 952016H0, 953016HS, 952016HS, 95303500, 95203500, 953035H0, 952035H0, 953035HS, 952035HS

1. THE RHEEM WARRANTY – GENERAL

- 1.1 This warranty is given by Rheem Australia Pty Limited ABN 21 098 823 511 of 1 Alan Street, Rydalmere New South Wales.
- 1.2 Rheem offer a trained and qualified national service network who will repair or replace components at the address of the water heater subject to the terms of the Rheem warranty. Rheem Service, in addition can provide preventative maintenance and advice on the operation of your water heater. The Rheem Service contact number is 131031, with Contact Centre personnel available 24 hours, 7 days a week to take your call and if necessary to arrange a service call for during normal working hours Monday to Friday (hours subject to change).
- 1.3 For details about this warranty, you can contact us for Australia on 131 031 or by email at warrantyenquiry@rheem.com.au (not for service bookings) and for New Zealand on 0800 657 335.
- 1.4 The terms of this warranty and what is covered by it are set out in section 2 and apply to water heaters manufactured after 1st July 2019.
- 1.5 If a subsequent version of this warranty is published, the terms of that warranty and what is covered by it will apply to water heaters manufactured after the date specified in the subsequent version.

2. TERMS OF THE RHEEM WARRANTY AND EXCLUSIONS TO IT

- 2.1 The decision of whether to repair or replace a faulty component is at Rheem's sole discretion.
- 2.2 Where a failed component or cylinder is replaced under this warranty, the balance of the original warranty period will remain effective. The replacement does not carry a new Rheem warranty.
- 2.3 Where the water heater is installed outside the boundaries of a metropolitan area as defined by Rheem or further than 25 km from either a regional Rheem branch office or an Accredited Rheem Service Agent's office, the cost of transport, insurance and travelling between the nearest branch office or Rheem Accredited Service Agent's office and the installed site shall be the owner's responsibility.
- 2.4 Where the water heater is installed in a position that does not allow safe or ready access, the cost of that access, including the cost of additional materials handling and/or safety equipment, shall be the owner's responsibility. In other words, the cost of dismantling or removing cupboards, doors or walls and the cost of any special equipment to bring the water heater to floor or ground level or to a serviceable position is not covered by this warranty.
- 2.5 This warranty only applies to the original and genuine Rheem water heater in its original installed location and any genuine Rheem replacement parts.
- 2.6 If the water heater is not sized to supply the hot water demand in accordance with the guidelines in Rheem's water heater literature, any resultant fault will not be covered by Rheem's warranty.
- 2.7 The Rheem warranty does not cover faults that are a result of:
 - a) Accidental damage to the water heater or any component (for example: (i) Acts of God such as floods, storms, fires, lightning strikes and the like; and (ii) third party acts or omissions).
 - b) Misuse or abnormal use of the water heater.

RHEEM HEAT PUMP WATER HEATER WARRANTY -AUSTRALIA & NEW ZEALAND ONLY-

- c) Installation not in accordance with the Owner's Guide and Installation Instructions or with relevant statutory and local requirements in the State or Territory in which the water heater is installed.
 - d) Connection at any time to a water supply that does not comply with the water supply guidelines as outlined in the Owner's Guide and Installation Instructions.
 - e) Repairs, attempts to repair or modifications to the water heater by a person other than Rheem Service or a Rheem Accredited Service Agent.
 - f) Faulty plumbing or faulty power supply.
 - g) Failure to maintain the water heater in accordance with the Owner's Guide and Installation Instructions.
 - h) Transport damage.
 - i) Fair wear and tear from adverse conditions (for example, corrosion).
 - j) Cosmetic defects.
- 2.8 If you require a call out and we find that the fault is not covered by the Rheem warranty, you are responsible for our standard call out charge. If you wish to have the relevant component repaired or replaced by Rheem, that service will be at your cost.
- 2.9 Subject to any statutory provisions to the contrary, this warranty excludes any and all claims for damage to furniture, carpet, walls, foundations or any other consequential loss either directly or indirectly due to leakage from the water heater, or due to leakage from fittings and/ or pipe work of metal, plastic or other materials caused by water temperature, workmanship or other modes of failure.

3. WHAT IS COVERED BY THE RHEEM WARRANTY FOR THE WATER HEATERS DETAILED IN THIS DOCUMENT

- 3.1 Rheem will repair or replace a faulty component of your water heater if it fails to operate in accordance with its specifications as follows:

What components are covered	The period in which the fault must appear in order to be covered	What coverage you receive
All components	Year 1	Repair and/or replacement of the faulty component, free of charge, including labour.
Sealed System* components	Year 2	Repair and/or replacement of the faulty component, free of charge, including labour.

* The Sealed System includes components that carry refrigerant only, e.g. Compressor, Condenser, TX Valve, Receiver / Drier, Evaporator and associated pipe work.

RHEEM HEAT PUMP WATER HEATER WARRANTY -AUSTRALIA & NEW ZEALAND ONLY-

4. ENTITLEMENT TO MAKE A CLAIM UNDER THIS WARRANTY

- 4.1 To be entitled to make a claim under this warranty you need to:
- a) Be the owner of the water heater or have consent of the owner to act on their behalf
 - b) Contact Rheem Service without undue delay after detection of the defect and, in any event, within the applicable warranty period.
- 4.2 You are **not** entitled to make a claim under this warranty if your water heater:
- a) Does not have its original serial numbers or rating labels.
 - b) Is not installed in Australia.

5. HOW TO MAKE A CLAIM UNDER THIS WARRANTY

- 5.1 If you wish to make a claim under this warranty, you need to:
- a) Contact Rheem on 131031 (for Australia) or 0800 657 335 (for New Zealand) and provide owner's details, address of the water heater, a contact number and date of installation of the water heater or if that's unavailable, the date of manufacture and serial number (from the rating label on the water heater)
 - b) Rheem will arrange for the water heater to be tested and assessed on-site.
 - c) If Rheem determines that you have a valid warranty claim, Rheem will repair or replace the water heater in accordance with this warranty
- 5.2 Any expenses incurred in the making of a claim under this warranty will be borne by you.

6. THE AUSTRALIAN CONSUMER LAW

- 6.1 Our goods come with guarantees that cannot be excluded under the *Australian Consumer Law*. You are entitled to a replacement or refund for a major failure and for compensation for any other reasonably foreseeable loss or damage. You are also entitled to have the goods repaired or replaced if the goods fail to be of acceptable quality and the failure does not amount to a major failure.
- 6.2 The Rheem warranty (set out above) is in addition to any rights and remedies that you may have under the *Australian Consumer Law*.

RHEEM AUSTRALIA PTY LTD
A.B.N. 21 098 823 511
www.rheem.com.au

FOR SERVICE TELEPHONE
131 031 AUSTRALIA
0800 657 335 NEW ZEALAND