

RP 350/RP 351 Press Tools



Table of Contents

Recording Form For Machine Serial Number	1
Safety Symbols/Symbols	2
General Power Tool Safety Warnings	
Work Area Safety	2
Electrical Safety	2
Personal Safety	3
Power Tool Use And Care	3
Battery Tool Use And Care	3
Service	4
Specific Safety Information	
Press Tool Safety.....	4
RIDGID® Contact Information	4
Description	4
Specifications	
Standard Equipment	7
Pre-Operation Inspection	7
Set-Up And Operaton	8
Removing/Installing Attachment	8
Preparing Connection	8
Pressing A Fitting With Typical Scissor Jaws	9
Pressing A Fitting With Typical Actuator And Press Ring Set	10
Inspecting The Pressed Connection	10
Bluetooth Functions (Wireless Data Transfer)	10
Cold Weather Operation	10
Storage	11
Maintenance Instructions	
Cleaning And Lubrication.....	11
Service And Repair	11
Troubleshooting	12
Optional Equipment	12
Disposal	13
Electromagnetic Compatibility (EMC)	14
FCC/ISED Statement)	14
EC Declaration of Conformity	Inside Back Cover
Lifetime Warranty	Back Cover

*Original Instructions - English

RP 350/RP 351

Press Tools



⚠ WARNING!

Read this Operator's Manual carefully before using this tool. Failure to understand and follow the contents of this manual may result in electrical shock, fire and/or serious personal injury.

RP 350/RP 351 Press Tools

Record Serial Number below and retain product serial number which is located on nameplate.

Serial
No.

--	--

Safety Symbols/Symbols

In this operator's manual and on the product, safety symbols and signal words are used to communicate important safety information. This section is provided to improve understanding of these signal words and symbols.

 This is the safety alert symbol. It is used to alert you to potential personal injury hazards. Obey all safety messages that follow this symbol to avoid possible injury or death.

 **DANGER** DANGER indicates a hazardous situation which, if not avoided, will result in death or serious injury.

 **WARNING** WARNING indicates a hazardous situation which, if not avoided, could result in death or serious injury.

 **CAUTION** CAUTION indicates a hazardous situation which, if not avoided, could result in minor or moderate injury.

NOTICE NOTICE indicates information that relates to the protection of property.

 This symbol means read the operator's manual carefully before using the equipment. The operator's manual contains important information on the safe and proper operation of the equipment.

 This symbol means always wear safety glasses with side shields or goggles when handling or using this equipment to reduce the risk of eye injury.

 This symbol indicates the risk of hands, fingers or other body parts being crushed.

 This symbol indicates the risk of electrical shock.

 This symbol indicates that the product is For Indoor Use Only.

 This symbol indicates that the product is Class II equipment.

 This symbol indicates this is electrical equipment that should not be disposed of with household waste. See "Disposal" section.

 This symbol indicates this is electrical equipment meets the requirements of the applicable EC directives.

 This symbol indicates the year of manufacture of the product.

General Power Tool Safety Warnings*

WARNING

Read all safety warnings, instructions, illustrations and specifications provided with this power tool. Failure to follow all instructions listed below may result in electric shock, fire and/or serious injury.

SAVE ALL WARNINGS AND INSTRUCTIONS FOR FUTURE REFERENCE!

The term "power tool" in the warnings refers to your mains-operated (corded) power tool or battery-operated (cordless) power tool.

Work Area Safety

- **Keep your work area clean and well lit.** Cluttered or dark areas invite accidents.
- **Do not operate power tools in explosive atmospheres, such as in the presence of flammable liquids, gases, or dust.** Power tools create sparks which may ignite the dust or fumes.
- **Keep children and by-standers away while operating a power tool.** Distractions can cause you to lose control.

Electrical Safety

- **Power tool plugs must match the outlet. Never modify the plug in any way. Do not use any adapter plugs with earthed (grounded) power tools.** Unmodified plugs and matching outlets will reduce risk of electric shock.
- **Avoid body contact with earthed or grounded surfaces such as pipes, radiators, ranges and refrigerators.** There is an increased risk of electrical shock if your body is earthed or grounded.
- **Do not expose power tools to rain or wet conditions.** Water entering a power tool will increase the risk of electrical shock.
- **Do not abuse the cord. Never use the cord for carrying, pulling or unplugging the power tool. Keep cord away from heat, oil, sharp edges or moving parts.** Damaged or entangled cords increase the risk of electric shock.
- **When operating a power tool outdoors, use an extension cord suitable for outdoor use.** Use of a cord suitable for outdoor use reduces the risk of electric shock.

* The text used in the General Power Tool Safety Warnings section of this manual is verbatim, as required, from the applicable UL/CSA 62841-1 standard. This section contains general safety practices for many different types of power tools. Not every precaution applies to every tool, and some do not apply to this tool.

- **If operating a power tool in a damp location is unavoidable, use a ground fault circuit interrupter (GFCI) protected supply.** Use of a GFCI reduces the risk of electric shock.

Personal Safety

- **Stay alert, watch what you are doing and use common sense when operating a power tool. Do not use a power tool while you are tired or under the influence of drugs, alcohol, or medication.** A moment of inattention while operating power tools may result in serious personal injury.
- **Use personal protective equipment. Always wear eye protection.** Protective equipment such as dust mask, non-skid safety shoes, hard hat, or hearing protection used for appropriate conditions will reduce personal injuries.
- **Prevent unintentional starting. Ensure the switch is in the OFF-position before connecting to power source and/or battery pack, picking up or carrying the tool.** Carrying power tools with your finger on the switch or energizing power tools that have the switch ON invites accidents.
- **Remove any adjusting key or wrench before turning the power tool ON.** A wrench or a key left attached to a rotating part of the power tool may result in personal injury.
- **Do not overreach. Keep proper footing and balance at all times.** This enables better control of the power tool in unexpected situations.
- **Dress properly. Do not wear loose clothing or jewelry. Keep your hair, clothing, and gloves away from moving parts.** Loose clothes, jewelry, or long hair can be caught in moving parts.
- **If devices are provided for the connection of dust extraction and collection facilities, ensure these are connected and properly used.** Use of dust collection can reduce dust-related hazards.
- **Do not let familiarity gained from frequent use of tools allow you to become complacent and ignore tool safety principles.** A careless action can cause severe injury within a fraction of a second.

Power Tool Use And Care

- **Do not force power tool. Use the correct power tool for your application.** The correct power tool will do the job better and safer at the rate for which it was designed.
- **Do not use power tool if the switch does not turn it ON and OFF.** Any power tool that cannot be con-

trolled with the switch is dangerous and must be repaired.

- **Disconnect the plug from the power source and/or remove the battery pack from the power tool before making any adjustments, changing accessories, or storing power tools.** Such preventive safety measures reduce the risk of starting the power tool accidentally.
- **Store idle power tools out of the reach of children and do not allow persons unfamiliar with the power tool or these instructions to operate the power tool.** Power tools are dangerous in the hands of untrained users.
- **Maintain power tools and accessories. Check for misalignment or binding of moving parts, breakage of parts and any other condition that may affect the power tool's operation. If damaged, have the power tool repaired before use.** Many accidents are caused by poorly maintained power tools.
- **Keep cutting tools sharp and clean.** Properly maintained cutting tools with sharp cutting edges are less likely to bind and are easier to control.
- **Use the power tool, accessories and tool bits etc. in accordance with these instructions, taking into account the working conditions and the work to be performed.** Use of the power tool for operations different from those intended could result in a hazardous situation.
- **Keep handles and grasping surfaces dry, clean and free from oil and grease.** Slippery handles and grasping surfaces do not allow for safe handling and control of the tool in unexpected situations.

Battery Tool Use And Care

- **Recharge only with the charger specified by the manufacturer.** A charger that is suitable for one type of battery pack may create a risk of fire when used with another battery pack.
- **Use power tools only with specifically designated battery packs.** Use of any other battery packs may create a risk of injury and fire.
- **When battery pack is not in use, keep it away from other metal objects, like paper clips, coins, keys, nails, screws or other small metal objects that can make a connection from one terminal to another.** Shorting the battery terminals together may cause burns or a fire.
- **Under abusive conditions, liquid may be ejected from the battery; avoid contact. If contact accidentally occurs, flush with water. If liquid contacts**

eyes, additionally seek medical help. Liquid ejected from the battery may cause irritation or burns.

- **Do not use a battery pack or tool that is damaged or modified.** Damaged or modified batteries may exhibit unpredictable behavior resulting in fire, explosion or risk of injury.
- **Do not expose a battery pack or tool to fire or excessive temperature.** Exposure to fire or temperature above 265 °F (130 °C) may cause explosion.
- **Follow all charging instructions and do not charge the battery pack or tool outside the temperature range specified in the instructions.** Charging improperly or at temperatures outside the specified range may damage the battery and increase the risk of fire.

Service

- **Have your power tool serviced by a qualified repair person using only identical replacement parts.** This will ensure that the safety of the power tool is maintained.
- **Never service damaged battery packs.** Service of battery packs should only be performed by the manufacturer or authorized service providers.

Specific Safety Information

⚠ WARNING

This section contains important safety information that is specific to this tool.

Read these precautions carefully before using the press tools to reduce the risk of electrical shock, or other serious injury.

SAVE ALL WARNINGS AND INSTRUCTIONS FOR FUTURE REFERENCE!

A compartment in the tool carrying case is included to keep this manual with the tool for use by the operator.

Press Tool Safety

- **Keep your fingers and hands away from pressing attachments during press cycle.** Your fingers or hands can be crushed, fractured or amputated if they become caught between the attachment or between these components and any other object.
- **Never attempt to repair damaged pressing attachments (jaws, press ring, actuator, etc.). Discard the entire damaged attachment.** An attachment that has been welded, ground, drilled or modified in any manner can shatter during pressing resulting in serious injury. Failure to replace the entire pressing attachment may result in component failure and serious injury.

- **Large forces are generated during product use that can break or throw parts and cause injury.** Stand clear during use and wear appropriate protective equipment, including eye protection.
- **Only use RIDGID® Press Tools with appropriate RIDGID or RIDGID approved Pressing attachments (jaws, press rings, actuators, etc.).** Other uses or modifying the Press Tools for other applications may damage the press tool, damage the attachments and/or cause personal injury.
- **Use proper tool, attachment and fitting combinations.** Improper combinations can result in an incomplete joint, which increase the risk of leaks, equipment damage and injury.
- **Before operating a RIDGID® Press Tool, read and understand:**
 - This operator’s manual
 - The attachment instructions
 - The battery/charger manual
 - The fitting manufacturer’s installation instructions
 - The instructions for any other equipment or material used with this tool

Failure to follow all instructions and warnings may result in property damage and/or serious injury.

RIDGID® Contact Information

If you have any question concerning this RIDGID® product:

- Contact your local RIDGID distributor.
- Visit RIDGID.com to find your local RIDGID contact point.
- Contact Ridge Tool Technical Service Department at rtctechservices@emerson.com, or in the U.S. and Canada call (800) 519-3456.

Description

The RIDGID® RP 350 and RP 351 Press Tools, when used with appropriate attachments, are designed to mechanically press fittings onto tubing to create a water-tight and permanent seal, such as for plumbing, heating, air conditioning, and refrigeration applications. Attachments are also available for other uses.

When the run switch on the press tool is depressed, an internal electric motor powers a hydraulic pump which sends fluid into the cylinder of the tool, moving the ram forward and applying force to the attachment, pressing the fitting. The press cycle takes approximately 4 seconds. Once the cycle begins to deform a fitting, it will automatically continue until completion, even if the run switch is released.

The tool includes a second operating mode (“Control Mode”) that can be turned on using the RIDGID Link App. Control Mode allows the fitting to be engaged prior to pressing to allow confirmation of proper alignment of the attachment, fitting and tube.

The Tool Status Lights indicate things such as tool status, battery status, maintenance required, or improper temperature. A work light turns ON when the run switch is depressed to illuminate the work area. The head can be rotated 360° for better access in tight spaces.

The tools are supplied with fabric loops that can be used with appropriate attachments such as shoulder straps or tie off lines.

The press tools include Bluetooth®* wireless technology to allow connection to smartphones and tablets. See “Bluetooth Functions (Wireless Data Transfer)” section for details.

* The Bluetooth® word mark and logos are registered trademarks by Bluetooth SIG, inc and any use of such marks by Emerson Electric Co. is under license. Other trademarks and trade names are those of their respective owners.



Figure 1 – RIDGID RP 350 Press Tool and Standard Series Jaw



Figure 2 – RIDGID RP 351 Press Tool and Standard Series Jaw

#	Description
1	Scissor Style Jaw Set
2	Attachment Mounting Pin
3	Tool Status Lights
4	ON/OFF Button
5	Warning Label (RP 351 Underside)
6	Fabric Loop
7	Pressure Release Button (RP 351 Far Side)
8	Handle
9	Battery
10	Run Switch
11	LED Work Light
12	Jaw Sideplate



Figure 3 – Machine Serial Number - Circled digits indicate the year and month of the manufacture. (YY = year, MM = month).







Control	Marking	Description
On/Off Button		Main tool power switch. (I = ON, O = OFF). ON: Press button until light turns ON. <i>See Figure 5 – Tool Status Lights.</i> OFF: Press button until light turns OFF. Tool will automatically turn OFF if left unused for ten (10) minutes.
Run Switch	—	Turn On Work Light: slightly depress run switch. Normal Mode: Depress run switch to start press cycle, release when tool locks on. Normal mode is factory setting. Control Mode: Depress run switch to engage attachment on workpiece. Make adjustments as necessary. Press the run switch again to start press cycle, release when tool locks on. Releasing the switch will not stop the tool once it has locked on. This assures consistent, repeatable press connection integrity. Mode can be changed with RIDGID Link App, <i>see Bluetooth Functions</i> section.
Pressure Release Button		Allows tool to be released without completing press. If used, press connection is not complete and must be repeated.
Attachment Mounting Pin	—	Holds attachment to tool. Must be fully inserted for tool to operate. <i>See Figure 6.</i>

Figure 4 – Controls Chart

	Light Segment Number (Light Continuously On)				Description
					
	—	—	—	—	Press tool off (OFF).
Green	Green	Green	Green	Green	ON button pressed, lights on 4 seconds at start up, tool in "Normal Mode".
Blue	Blue	Blue	Blue	Blue	ON button pressed, lights on 4 seconds at start up, tool in "Control Mode" - see <i>Bluetooth Functions</i> section to change mode.
Green	—	—	—	—	Press tool is in Normal Mode, standby, press tool ready to operate.
Red	Yellow	Yellow	Yellow	Yellow	Tool has malfunctioned. Tool will not operate. Remove and reinsert battery or AC Adapter. If light still on, have tool serviced.
Red	—	—	—	—	Tool has malfunctioned. Tool will not operate. Remove and reinsert battery or AC Adapter. If red light still on, have tool serviced.
Yellow	—	Red	Red	Red	Tool and/or battery out of Specification temperature range. Tool will not operate. Bring the tool and battery to correct operating temperature range.
Yellow	—	—	Red	Red	Attachment mounting pin is not fully inserted. Tool will not operate. Fully insert pin. If lights still on, have tool serviced.
Yellow	Red	—	—	—	Battery low. Tool will not operate. Recharge battery/Insert fully charged battery.
Green	Blue	Blue	Blue	Blue	Bluetooth connection established, standby, press tool ready to operate - For further information see section on <i>Bluetooth Functions</i> .
		Purple			Firmware update in process, tool cannot be used while updating.

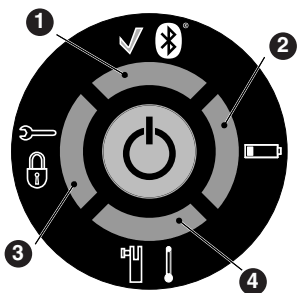



Figure 5 – Tool Status Lights

Specifications

RP 350 Pistol Press Tool	RP 351 Inline Press Tool
Attachments.....RIDGID Standard Series	RIDGID Standard Series
Stroke Length1.57" (40 mm)	1.57" (40 mm)
Motor	
Voltage18 V DC rated	18 V DC rated
Amperage.....23 A	23 A
Power.....480 Watts	480 Watts
Ram Force.....7,200 lbs. (32 kN)	7,200 lbs. (32 kN)
Head Rotation.....360°	360°
Duty Cycle3 Press  /min.	3 Press  /min
Power SupplyRIDGID RB-18XX Series 18 V Li-Ion Battery Pack or RIDGID RPA 120/220 AC Power Adapter (See <i>Optional Equipment Section</i>)	
Bluetooth Range33 ft. (10 m)	33 ft. (10 m)
Permissible Humidity80% maximum	80% maximum
Operating Temperature	
Range.....15° F to 122° F (-10° C to 50° C)	15° F to 122° F (-10° C to 50° C)
Storage Temperature.....32° F to 113° F (0° C to 45° C)	32° F to 113° F (0° C to 45° C)
Weight (no battery/ attachment)7.83 lbs (3.55 kg)	7.83 lbs (3.55 kg)
Dimensions11.3" x 11.0" x 3.1" 287 mm x 279 mm x 77 mm	15.7" x 4.65" x 3.1" 398 mm x 118 mm x 77 mm
Sound Pressure (L _{PA})*<74.5 dB(A), K=3 dB(A)	<74.5 dB(A), K=3 dB(A)
Vibration*<1.13 m/s ² , K=1.5	<1.13 m/s ² , K=1.5

* Sound and Vibration measurements are measured in accordance with a standardized test per Standard EN 62481-1.
 - Vibration levels may be used for comparison with other tools and for preliminary assessment of exposure.
 - Sound and vibration emissions may vary due to your location and specific use of these tools.
 - Daily exposure levels for sound and vibration need to be evaluated for each application and appropriate safety measures taken when needed. Evaluation of exposure levels should consider the time a tool is switched OFF and not in use. This may significantly reduce the exposure level over the total working period.

Standard Equipment

Refer to the RIDGID catalog for details on equipment supplied with specific tool catalog numbers.

NOTE! RIDGID press tool attachments are offered in two "series"

- Standard Series
- Compact Series

These attachment series are not interchangeable. Standard series attachments will only work with standard series tools (RP 350, RP 351, RP 342-XL, RP 340, RP 330, 320-E, CT-400). Compact series attachments will only work with compact series tools (RP 240, RP 241, RP 200, RP 210, 100B).

NOTICE Selection of appropriate materials and joining methods is the responsibility of the system designer and/or installer. Before any installation is attempted, careful evaluation of the specific service environment, including

chemical environment and service temperature, should be completed. Consult Press Fitting System manufacturer for selection information.

Pre-Operation Inspection

 **WARNING**





Daily before use, inspect your press tool and correct any problems to reduce the risk of serious injury from electric shock, crushing injuries, attachment failure and other causes, and prevent tool damage.

1. Switch OFF the tool and remove battery/AC Adapter from tool.
2. Clean any oil, grease or dirt from the equipment, especially the handles and controls. This aids inspec-

tion and helps to prevent the tool or controls from slipping from your grip.

3. Inspect the press tool for:
 - Proper assembly, maintenance and completeness.
 - Any broken, worn, missing, misaligned or binding parts. Confirm fabric loops are in good condition.
 - Smooth movement of attachment mounting pin between the fully open and fully closed position. Pin should lock into each position. Confirm that the run switch moves freely and does not bind or stick.
 - Presence and readability of warning label (Figure 6).
 - Any other condition which may prevent safe and normal operation.

Do not use the press tool until problems have been repaired.



Figure 6 – Status Lights/Warning Label

4. Inspect and maintain tool attachments per their instructions. Remove attachment from the tool. Confirm that attachments are in good condition and clearly marked as to use.
5. Inspect and maintain any other equipment being used per its instructions to make sure it is functioning properly.

Set-Up and Operation

⚠ WARNING



Keep your fingers and hands away from the tool attachment during the press cycle. Your fingers or hands can be crushed, fractured or amputated in the attachment, tool, between the tool and attachment, work piece and other objects.

Large forces are generated during product use that can break or throw parts and cause injury. Stand clear during use and wear appropriate protective equipment, including eye protection.

Use proper tool, attachment and fitting combinations. Improper combinations can result in an incomplete press connection, which increases the risk of leaks, equipment damage and injury.

Use proper tool, attachment and fitting combinations. Improper combinations can result in an incomplete press connection, which increases the risk of leaks, equipment damage and injury.

Follow Set-up and Operation to reduce the risk of injury from crushing and other causes and to prevent tool damage.

1. Confirm appropriate work area (See *General Power Tool Safety Warnings*). Operate in a clear, level, stable, dry location. Do not use tool while standing in water.
2. Inspect the work to be done and determine the correct RIDGID tool and RIDGID attachment for the application per their specifications. Using incorrect equipment for an application can cause injury, damage the tool and make incomplete connections.
3. Confirm all equipment has been inspected and set up as directed in their instructions.

Removing/Installing Attachment

1. Switch OFF the tool and remove battery/AC Adapter from tool.
2. Fully open the attachment mounting pin. Remove/insert the appropriate attachment (Figure 7).
3. Fully close the attachment mounting pin until it locks into the closed position. Attachment mounting pin must be fully closed to prevent tool damage during use. Tool lights will be lit to indicate, see Figure 5 for Tool Status Lights.

NOTE! Do not operate tool without the attachment in place, this can damage the tool.



Figure 7 – Attachment Mounting Pin

Preparing Connection

NOTICE These instructions are generalized practices for several types of press tool attachments. Always follow the specific instructions for the press tool attachment being used and the fitting manufacturers' specific installation instructions to reduce the risk of improper press connections and extensive property damage.

1. Prepare the press connection according to the fitting manufacturer's instructions.

2. With dry hands, insert a fully charged battery or AC Adapter into tool. If using the corded power adapter with a GFCI, the GFCI (RCD) should have a rated residual current of 30 mA or less. Depress ON/OFF button one time to turn tool ON. All LEDs will be lit green indicating that the tool is ready to use. See *Figure 5 – Tool Status Lights* for any other light.

Pressing A Fitting With Typical Scissor Jaws

1. Properly hold the tool with both hands.



Figure 8 – Holding the Tool

2. Squeeze jaw arms to open jaws.
3. Place open jaws around fitting (*Figure 9*). Properly align jaw press profile with contour of the fitting as specified in Fitting Manufacturer's Installation Instructions. Release jaw arms to close jaws around fitting. Do not hang jaw set from fitting. Tool could unexpectedly drop and cause serious injury or death.



Figure 9 – Placing Scissor-Style Jaws Around Fitting

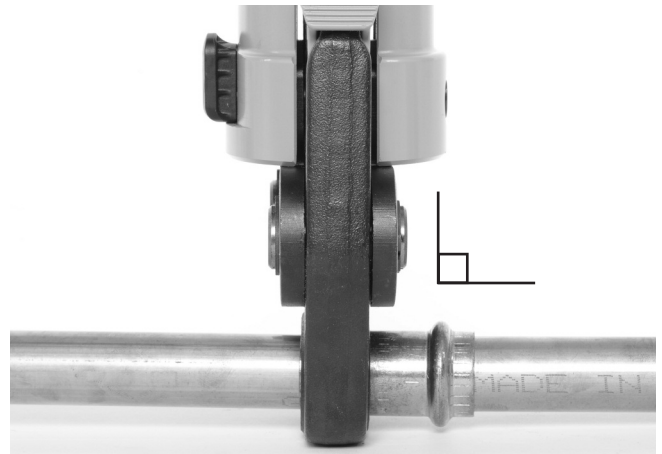

Figure 10 – Jaws Square to Fitting

4. Confirm jaw is appropriately placed and square to fitting (*Figure 10*). Keep fingers and hands away from the jaws to avoid crushing injuries in jaws or between jaws and surroundings.

Normal Mode: Depress the run switch (*Figures 1 & 2*). Once the tool cycle begins and the rollers contact the jaw arms, the tool will lock-on and automatically complete the cycle. Releasing the switch will not stop the tool once it has locked on. This assures consistent, repeatable press connection integrity.

Control Mode: Depress the run switch (*Figures 1 & 2*). The jaws will engage the fitting but the press connection is not made. Make adjustments as necessary. Press the run switch again, the tool will lock-on and automatically complete the cycle. Releasing the switch will not stop the tool once it has locked on. This assures consistent, repeatable press connection integrity.

If tool must be removed before a press connection is completed, depress the pressure release button (*Figures 1 & 2*).

NOTICE Any time release button is depressed, the press connection is NOT complete and the fitting must be pressed again to ensure completion. If the tool malfunctions during operation, use this procedure.

5. Release the run switch.
6. Squeeze jaw arms to open jaws.
7. Remove jaw from fitting. Avoid sharp edges that may have formed on fitting during pressing operation.
8. When operation is complete, depress ON/OFF button one time to turn tool OFF. Remove battery or AC Adapter from tool.

Pressing A Fitting With Typical Actuator And Press Ring Set

1. Open ring and place around fitting. Properly align ring press profile with contour of the fitting as specified in *Fitting Manufacturer's Installation Instructions*. Release ring to close around fitting (*Figure 11*).
2. Confirm appropriate actuator is properly installed in tool. Squeeze actuator arms to open the actuator tips. Align actuator tips with ring pockets. Release actuator arms and fully engage actuator tips into ring pockets (*Figure 12*). Misaligning actuator tip to ring pocket can damage the ring or actuator during pressing. Do not hang tool and actuator from press ring. Tool could unexpectedly drop and cause serious injury or death.



Figure 11 – Installing Press Ring Onto Fitting



Figure 12 – Attaching Actuator to Press Ring

3. Confirm ring is appropriately placed and square to fitting. Keep fingers and hands away from the actuator and ring to avoid crushing injuries in attachment or between attachment and surroundings.

Normal Mode: Depress the run switch (*Figures 1 & 2*). Once the tool cycle begins and the rollers contact the jaw arms, the tool will lock-on and automatically com-

plete the cycle. Releasing the switch will not stop the tool once it has locked on. This assures consistent, repeatable press connection integrity.

Control Mode: Depress the run switch (*Figures 1 & 2*). The jaws will engage the fitting but the press connection is not made. Make adjustments as necessary. Press the run switch again, the tool will lock-on and automatically complete the cycle. Releasing the switch will not stop the tool once it has locked on. This assures consistent, repeatable press connection integrity.

4. If tool must be removed before a press connection is completed, depress the pressure release button (*Figures 1 & 2*).

NOTICE Any time release button is depressed, the press is NOT complete and the press connection must be pressed again to ensure completion. If the tool malfunctions during operation, use this procedure.

5. Release the run switch.
6. Squeeze actuator arms to open actuator. Remove actuator from fitting.
7. Remove ring from fitting. Avoid sharp edges that may have formed on fitting during pressing operation.
8. When operation is complete, depress ON/OFF button one time to turn tool OFF. Remove battery or AC Adapter from tool.

Inspecting The Pressed Connection

1. Inspect the pressed fitting for:
 - Full insertion of tube into fitting.
 - Excessive misalignment of the tubes. A slight amount of misalignment at a press connection is considered normal.
 - Incorrect attachment alignment with the fitting contour. Distorted or deformed fitting.
 - Any other issues per the fitting manufacturer. This could include the removal of a control ring or decal (used to indicate the connection has not yet been pressed).

If any issues are found, remove fitting and install a new press connection.

2. Test the press connection in accordance with connector manufacturer instructions, normal practice and applicable codes.

Bluetooth Functions (Wireless Data Transfer)

The RIDGID® RP 350 and RP 351 Press Tools include Bluetooth® wireless technology allowing wireless data

transfer to properly equipped smartphones or tablets (“devices”) running iOS or Android operating systems.

1. Download the appropriate RIDGID® Link app to your device by going to RIDGID.com/apps, the Google Play Store or the Apple App Store.
2. When the tool is ON, a Bluetooth wireless technology equipped device can find and pair with the press tool. In the Bluetooth settings of your device, select desired RIDGID tool. Refer to your device instructions for specific information on how to connect via Bluetooth wireless technology. Once connected, the green-blue-blue-blue tool status lights will be lit.

After the initial pairing, most devices will automatically connect to the Tools when the Bluetooth wireless technology is active and in range and if device settings are configured to do so. Press tools should be less than 33 ft. (10 m) from the device to be detected. Any obstacle between the tool and device can reduce the operational range.
3. Follow the app instructions for proper use. The mode of operation can be changed via app. The app also allows monitoring of tool cycles.
4. The wireless data transfer turns OFF when the press tool is switched OFF. Turn Bluetooth wireless device OFF to reduce device battery drain.

Cold Weather Operation

As temperature drops, hydraulic fluid thickens and battery performance degrades. To reduce the risk of improper operation, the RP 350 and RP 351 will not operate outside of the specification temperature range as indicated by the tool status lights (*Figure 5*).

When ambient conditions are outside the specification temperature range, keep the tool and batteries in a conditioned space until ready to use.

Storage

Remove battery or AC Adapter from the press tool. Store press tool and battery in case. Avoid storing in extreme heat or cold. The tool will not turn ON if the tool is outside the specification range. This will be indicated by the tool status lights. (*See Figure 5*)

⚠ WARNING Store tool in a dry, secured, locked area that is out of reach of children and people unfamiliar with the press tool. The tool is dangerous in the hands of untrained users.

Maintenance Instructions

⚠ WARNING

Make sure tool is switched OFF and battery or AC Adapter is removed from tool before performing maintenance or making any adjustment.

Cleaning And Lubrication

1. Wipe the tool clean daily with a clean dry cloth.
2. Inspect the attachment mounting pin and lubricate the pin with silicone lubricant as needed.
3. Check return springs in attachments with each use. Attachments should open and close freely with only moderate finger effort required.

Service And Repair

⚠ WARNING

Improper service or repair can make tool unsafe to operate.

Service and repair on the RP 350 and RP 351 Press Tools must be performed by a RIDGID Independent Press Tool Service Center.

For information on your nearest RIDGID Authorized Independent Service Center or any service or repair questions see *Contact Information* section in this manual.

Troubleshooting

SYMPTOM	POSSIBLE REASONS	SOLUTION
Tool will not turn ON when ON/OFF button is pressed.	Battery is completely discharged or battery has failed. Battery not properly inserted into handle of tool AC adapter not correctly inserted into the tool.	Insert fully charged battery/recharge battery. Check to assure battery is fully inserted. Correctly insert AC adapter into tool.
Attachment is locked onto fitting.	Press connection was not successfully completed.	Push pressure release button to remove jaws from fitting. Inspect and repress fitting.
The pressed connections produced are not complete.	Used wrong jaw for the tube size or material. The tool was not square to the tube. Attachment press contour was not aligned with the fitting contour. Tool is in need of repair.	Install the correct attachment. Redo the press connection with new fitting and new tube. Make sure that the tool is square to the tube. Redo the joint with new tube and new fitting. Make sure the attachment press contour is aligned with the fitting contour. Take for service.
Oil leaks from tool.	Seal or mechanical problems.	
Motor runs but tool will not complete a cycle.	Oil level low.	Take for service.
Tool stops during operation.	Oil level low.	

See Figure 5 – Tool Status Lights

Optional Equipment

⚠ WARNING

To reduce the risk of serious injury, only use equipment specifically designed and recommended for use with the RP 350 and RP 351 Press Tools, such as listed below.

Battery and Adapter Packs

Catalog No.	Description
56513	RB-1825 18V 2.5 Ah Lithium Ion Battery
56518	RB-1850 18V 5.0 Ah Lithium Ion Battery
44468	120 AC Power Adapter – North America
43338	220 AC Power Adapter– Europe
44823	120 AC Power Adapter – China

Chargers and Cords

Catalog No.		Region	Plug Type
64383	RBC-30 Charger	North America	A
56523	RBC-30 Charger	Europe	C
64388	RBC-30 Charger	China	A
64393	RBC-30 Charger	Australia	I
64378	RBC-30 Charger	Japan	A
64398	RBC-30 Charger	United Kingdom	G
64173	RBC-30 Charger Cord	North America	A
64183	RBC-30 Charger Cord	Europe	C

For a complete listing of RIDGID equipment available for these tools, see the Ridge Tool Catalog online at RIDGID.com or see *Contact Information*.

Disposal

Parts of these tools contain valuable materials and can be recycled. There are companies that specialize in recycling that may be found locally. Dispose of the components in compliance with all applicable regulations. Contact your local waste management authority for more information.



For EC Countries: Do not dispose of electrical equipment with household waste!

According to the European Guideline 2012/19/EU for Waste Electrical and Electronic Equipment and its implementation into national legislation, electrical equipment that is no longer usable must be collected separately and disposed

of in an environmentally correct manner.

Electromagnetic Compatibility (EMC)

The term electromagnetic compatibility is taken to mean the capability of the product to function smoothly in an environment where electromagnetic radiation and electrostatic discharges are present and without causing electromagnetic interference to other equipment.

NOTICE These tools conform to all applicable EMC standards. However, the possibility of them causing interference in other devices cannot be precluded. All EMC related standards that have been tested are called out in the tool's technical document.

FCC/ICES Statement

This device complies with Part 15 of the FCC Rules. Operation is subject to the following two conditions:

1. This device may not cause harmful interference.
2. This device must accept any interference received, including interference that may cause undesired operation.

Modifications not expressly approved by this company could void the user's authority to operate the equipment.

This equipment has been tested and found to comply with the limits for a Class A digital device, pursuant to part 15 of the FCC Rules. These limits are designed to provide reasonable protection against harmful interference when the equipment is operated in a commercial environment. This equipment generates, uses, and can radiate radio frequency energy and, if not installed and used in accordance with the instruction manual, may cause harmful interference to radio communications. Operation of this equipment in a residential area is likely to cause harmful interference in which case the user will be required to correct the interference at his own expense.

This product complies with the Canadian ICES-003 Class A specifications. See *Declaration label on tool*.

RIDGID® RP 350/RP 351 Press Tools

MANUFACTURER
RIDGE TOOL COMPANY
400 Clark Street
Elyria, Ohio 44035-6001
U.S.A.

RTCRegulatory.Compliance@Emerson.com

EC DECLARATION OF CONFORMITY

We declare that the machines listed above, when used in accordance with the operator's manual, meet the relevant requirements of the Directives and Standards listed below.

DÉCLARATION DE CONFORMITÉ CE

Nous déclarons que lorsqu'elles sont utilisées selon leur mode d'emploi, les machines indiquées ci-dessus répondent aux exigences applicables des directives et normes ci-après.

DECLARACIÓN DE CONFORMIDAD DE LA CE

Declaramos que las máquinas listadas más arriba, cuando se usan conforme al manual del operario, cumplen con los requisitos pertinentes de las directrices y normas listadas a continuación.

PROHLÁŠENÍ O SHODĚ ES

Prohlašujeme, že výše uvedené nástroje a zařízení splňují při použití v souladu s jejich návodem k obsluze příslušné požadavky níže uvedených směrnic a nařízení.

EF-OVERENSSTEMMELSESERKLÆRING

Vi erklærer, at de ovenfor anførte maskiner, ved brug i overensstemmelse med brugervejledningen, opfylder de relevante krav i de nedenfor anførte direktiver og standarder.

EG KONFORMITÄTSESKLÄRUNG

Wir erklären, dass die oben aufgeführten Maschinen, wenn sie entsprechend der Bedienungsanleitung verwendet werden, die einschlägigen Anforderungen der folgenden Richtlinien und Normen erfüllen.

ΔΗΛΩΣΗ ΣΥΜΜΟΡΦΩΣΗΣ ΕΚ

Δηλώνουμε ότι τα μηχανήματα που αναφέρονται παραπάνω, όταν χρησιμοποιούνται σύμφωνα με το εγχειρίδιο χειρισμού, πληρούν τις σχετικές απαιτήσεις των παρακάτω Οδηγιών και Προτύπων.

EY-VAATIMUSTENMUKAISUUSVAKUUTUS

Vakuutamme, että edellä luetellut koneet täyttävät käyttöohjekirjan mukaisesti käytettynä seuraavien direktiivien ja standardien vaatimukset.

EU IZJAVA O SUKLADNOSTI

Izjavljujemo da su gore navedeni strojevi, kada se koriste u skladu s priručnikom za korisnike, sukladni s relevantnim zahtjevima dolje navedenih direktiva i standarda.

EK MEGFELELŐSÉGI NYILATKOZAT

Kijelentjük, hogy a fent felsorolt gépek - amennyiben a kezelési útmutatónak megfelelően használszák őket - megfelelnek az alább felsorolt irányelvek és Szabványok követelményeinek.

DICHIARAZIONE DI CONFORMITÀ CE

Dichiariamo che le macchine elencate in alto, se utilizzate in conformità con il manuale dell'operatore, soddisfano i relativi requisiti delle Direttive e degli Standard specificati di seguito.

EO СӘЙКЕСТІК МӘЛІМДЕМЕСІ

Біз жоғарыда көрсетілген құрылғылардың пайдаланушы нұсқаулығына сәйкес пайдаланылған жағдайда төменде көрсетілген Директивалар мен Стандарттардың тиісті талаптарына жауап беретінін мәлімдейміз.

EG-CONFORMITEITSVERKLARING

Hierbij verklaren wij dat de hierboven vermelde machines, mits gebruikt in overeenstemming met de handleiding, voldoen aan de relevante eisen van de hieronder vermelde richtlijnen en normen.

CE-SAMSVARERKLÆRING

Vi erklærer at maskinene oppført over oppfyller de relevante kravene i direktiver og standarder oppført under dersom de brukes i henhold til bruksanvisningen.

AUTHORIZED REPRESENTATIVE

Ridge Tool Europe NV
Ondernemerslaan 5428
3800 Sint-Truiden, Belgium
europeproductcompliance@emerson.com
+40 374132035

DEKLARACJA ZGODNOŚCI WE

Deklarujemy, że maszyny wymienione powyżej, gdy są używane zgodnie z podręcznikiem użytkownika, spełniają właściwe wymagania Dyrektyw i Standardów, wymienione poniżej.

DECLARAÇÃO DE CONFORMIDADE CE

Declaramos que as máquinas listadas acima, quando utilizadas de acordo com o manual do operador, cumprem os requisitos relevantes das Diretivas e Normas listadas abaixo.

DECLARAȚIE DE CONFORMITATE CE

Declaram că mașina specificată mai jos, atunci când este utilizată în conformitate cu manualul de exploatare, îndeplinește cerințele relevante ale Directivelor și standardelor specificate mai jos.

ДЕКЛАРАЦИЯ СООТВЕТСТВИЯ ЕС

Мы заявляем, что инструменты, перечисленные выше, при условии использования согласно руководству по эксплуатации, отвечают соответствующим требованиям указанных ниже директив и стандартов.

ES PREHLÁŠENIE O ZHODE

Vyhlasujeme, že stroje uvedené vyššie spĺňajú relevantné požiadavky smerníc a noriem uvedených nižšie, ak sa používajú podľa návodu na použitie.

IZJAVA ES O SKLADNOSTI

Izjavljamo, da zgoraj omenjeni stroji, ko se uporabljajo skladno z uporabniškim priročnikom, izpolnjujejo relevantne zahteve spodaj omenjenih direktiv in standardov.

EC DEKLARACIJA O USAGLAŠENOSTI

Izjavljujemo da gore navedeni strojevi, ako se koriste u skladu s priručnikom za korisnike, zadovoljavaju relevantne zahteve direktiva i standarda koji se navode dole.

EG-FÖRSÄKRAN OM ÖVERENSSTÄMMELSE

Vi meddelar att maskinen som anges ovan uppfyller de aktuella kraven i de angivna direktiven och standarderna nedan när den används enligt bruksanvisningen.

AB UYGUNLUK BEYANI

Yükarıda listelenen makinelerin, kullanıcı kılavuzuna göre kullanıldığında, aşağıda listelenen Direktiflerin ve Standartların ilgili gereksinimlerini karşıladığını beyan ederiz.

EÜ VASTAVUSDEKLARATSIOON

Kinnitame, et eelpool loetletud masinad vastavad allpool loetletud direktiivide ja standardite asjakohastele nõuetele, kui neid kasutatakse vastavalt kasutusjuhendile.

EK ATBILSTĪBAS DEKLARĀCIJA

Mēs apliecinām, ka iepriekšminētās iekārtas, izmantojot tās saskaņā ar operatora rokasgrāmatu, atbilst attiecīgajām tālāk norādīto direktīvu un standartu prasībām.

DEARBHÚ COMHRÉIREACHTA AN CE

Fógraímid go bhfuil na hinnill sa liosta thuas i gcomhréir le riachtanais ábhartha na dTreoracha agus na gCaighdeán sa liosta thíos, ach iad a úsáid de réir an lámhleabhair don oibreoir.

EB ATITIKTIES DEKLARACIJA

Deklaruojame, kad pirmiau išvardytos mašinos, jei naudojamos pagal naudotojų vadovą, atitinka atitinkamus toliau išvardytų direktyvų ir standartų reikalavimus.

EO ДЕКЛАРАЦИЯ ЗА СЪОТВЕТСТВИЕ

Декларираме, че изброените по-горе машини, когато се използват в съответствие с Ръководство за оператора, отговарят на съответните изисквания на директивите и стандартите, изброени по-долу.



2006/42/EC, 2014/30/EU, 2011/65/EU
IEC 62841-1, EN 61000-6-1, EN 61000-6-3



Complies with UL 62841-1
CSA C22.2 No. 62841-1



UK Importer
Ridge Tool UK (RIDGID)
44 Baker Street
London W1U 7AL, UK

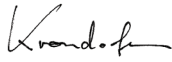

Signature: 
Name: Harald Krondorfer
Qualification: V.P. Engineering
Date: 07/18/2022



AUSTRALIAN WARRANTY

What is covered

RIDGID® tools are warranted to be free of defects in workmanship and material.

This warranty is in addition to your rights and remedies under the Australian Consumer Law and other laws.

How long coverage lasts

This warranty lasts for the lifetime of the RIDGID® tool. Warranty coverage ends when the product becomes unusable for reasons other than defects in workmanship or material.

How you can get service

To obtain the benefit of this warranty, deliver via prepaid transportation the complete product to Ridge Tool (Australia) Pty Ltd ("RIDGE TOOL") (see address below), or any authorized RIDGID® INDEPENDENT SERVICE CENTER. Pipe wrenches and other hand tools can also be returned to the place of purchase.

You will be responsible for the costs of making a claim under this warranty.

What we will do to correct problems

Warranted products will be repaired or replaced, at RIDGE TOOL'S option, and returned at no charge; or, if after three attempts to repair or replace during the warranty period the product is still defective, you can elect to receive a full refund of your purchase price.

What is not covered

Failures due to misuse, abuse or normal wear and tear are not covered by this warranty. RIDGE TOOL shall not be responsible for any incidental or consequential damages.

No other express warranty applies

No employee, agent, dealer, or other person is authorized to alter this warranty or make any other warranty on behalf of RIDGE TOOL.

Your statutory rights

Our goods come with guarantees that cannot be excluded under the Australian Consumer Law. You are entitled to a replacement or refund for a major failure and compensation for any other reasonably foreseeable loss or damage. You are also entitled to have the goods repaired or replaced if the goods fail to be of acceptable quality and the failure does not amount to a major failure.

Contact details:

Ridge Tool (Australia) Pty Ltd (ABN 96 008 446 482)
127 Metrolink Circuit
Campbellfield Victoria 3061, Australia
Tel: +61 3 9930 7000



FULL LIFETIME WARRANTY (garantie légale étendue à la durée de vie du produit,
voir conditions de garantie / legal warranty extended to the product lifecycle,
see warranty conditions)

Ridge Tool Company

400 Clark Street
Elyria, Ohio 44035-6001
U.S.A.

Parts are available online at Store.RIDGID.com

Printed 9/22
ECN000956

© 2020, 2022 Ridge Tool Company
RIDGID and the Emerson logo are registered trademarks of Emerson Electric Co. or its subsidiaries in the US and other countries.
Any other trademarks belong to their respective holders.

999-995-220.10
REV. C

RIDGID

EMERSON