

Zip

Upgrade your washroom
with Zip Touch Free.

ZIP TOUCH-FREE™



Hand washing



Hand drying



Pan flushing



Urinal flushing



Plus HORNE™
thermostatic
mixing valves



Contents

Touch-Free Hand Washing	6-7
Thermostatic Mixing Valves	8-11
Touch-Free Hand Drying	12-13
Touch-Free Pan Flushing	14-15
Touch-Free Automatic Single-Stall Urinal Flushing	16-17
Touch-Free Automatic Multiple-Stall Urinal Flushing	18-19

Zip leads the way in touch-free washroom systems.

Experienced consultants

When you are considering specification of touch-free washroom concepts, remember – Zip has been leading the way in touch-free washroom technology for more than 15 years. Zip touch-free taps, hand dryers and flushing systems are installed in tens of thousands of washrooms in every type of building and in every part of Australia.

Installation training

For more than 10 years, Zip has been providing on-site training in touch-free washroom specification, installation, trouble-shooting and routine maintenance. Architects, interior designers, plumbing contractors and maintenance contractors are welcome to take advantage of our training seminars as a free-of-charge service.

National service network

Zip touch-free washroom systems are backed by a network of qualified service technicians covering virtually the whole of Australia. The network comprises more than 50 full-time mobile Zip service technicians in major cities, plus more than 300 accredited service technicians covering the smaller cities and country towns.



Zip touch-free washroom products are now widely adopted by leading hospitals, clinics, bars, food outlets and food factories Australia-wide.

Some leading Australian users of Zip touch-free washroom systems:



Queensland Performing Arts Centre, Brisbane



Brisbane Convention and Exhibition Centre



Number One Martin Place, Sydney

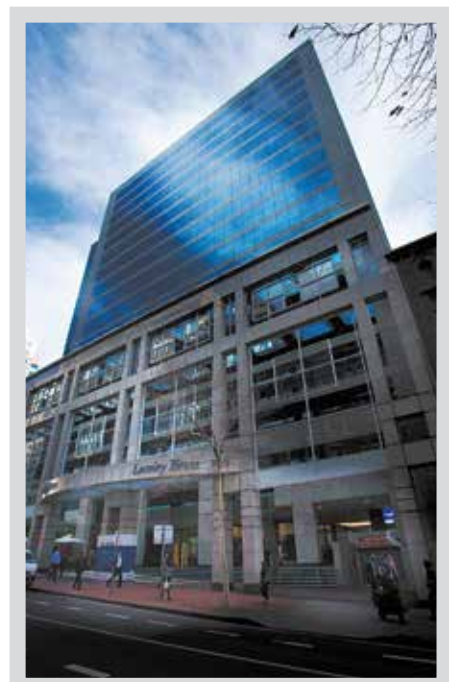

Office Building, 309 Kent Street, Sydney

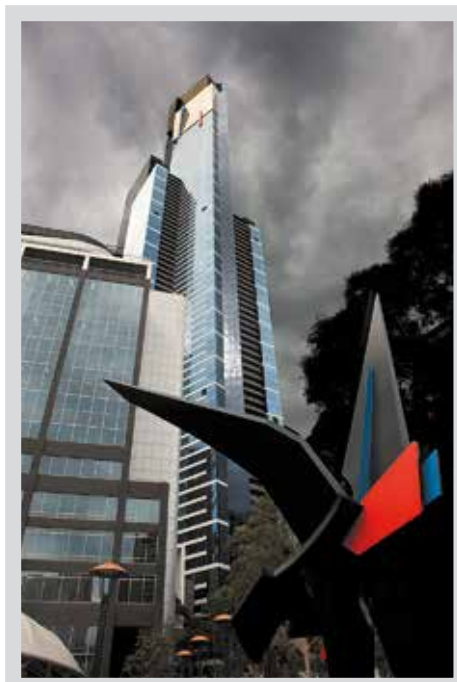

Level 89 Function Centre, Eureka Tower, Melbourne



Westfield, Pitt Street, Sydney



St Vincent's Private Hospital, Sydney



The Mater Hospital, Brisbane



Alfred Hospital, Prahran, Melbourne

Zip Touch-Free Infrared Taps

for superior hygiene in any location

- Six-star WELS water rating, cuts water consumption.
- Designed to deliver water at 3.5 litres per minute.
- Nozzle gives an aggressive spray (versus a cascade) for high cleansing capability at a low flow rate.
- Sensor is positioned to prevent accidental activation.
- Design minimises run-on due to reflective surfaces.
- Solenoid latching valve supplied, with connections.
- Power pack (240/6 volt) connects to 10 amp GPO.
- Lithium battery pack option for simpler installation.
- Heavy duty construction to avoid vandal damage.
- For temperature controlled water, see pages 8-11.



Deck Mounted Vertical.
Models 42220 and 42221.
Polished Chrome Brass.



Deck Mounted Diagonal.
Models 42208 and 42211.
Brushed stainless steel.



Wall Mounted Short.
Models 42223 and 42222.
Brushed stainless steel.

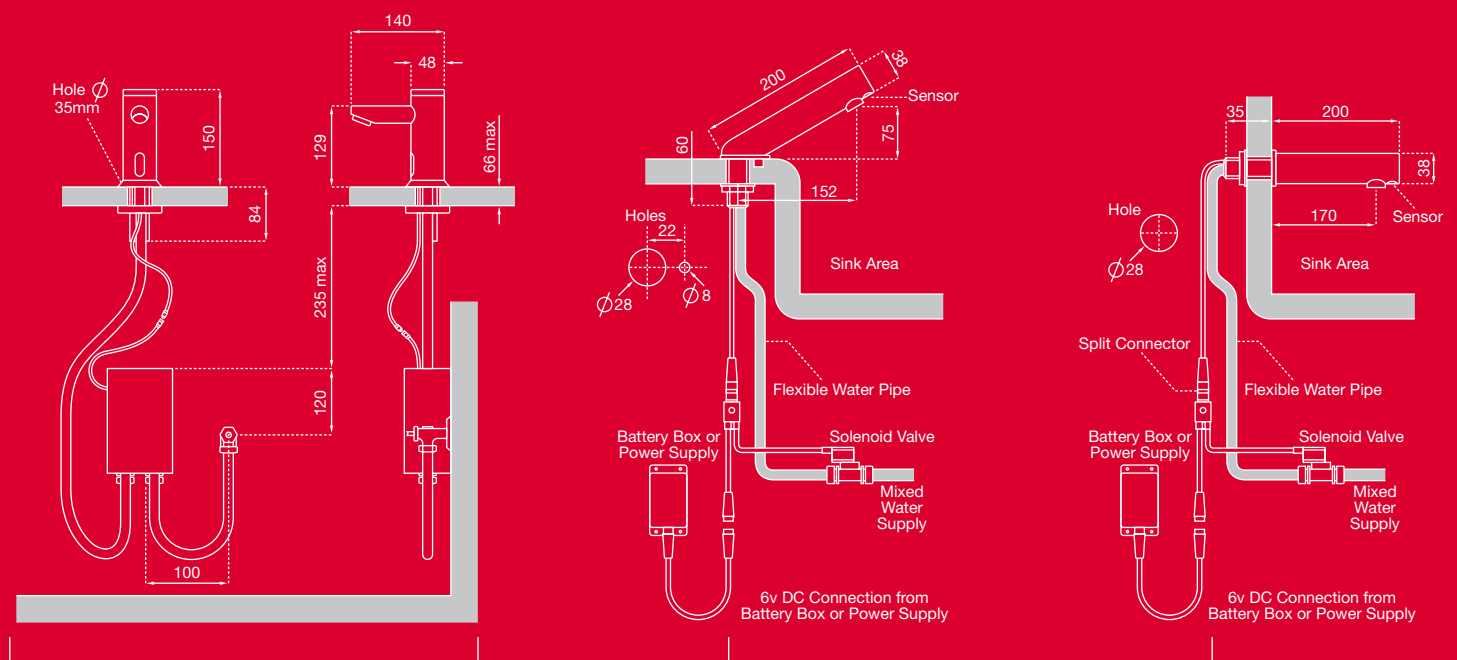

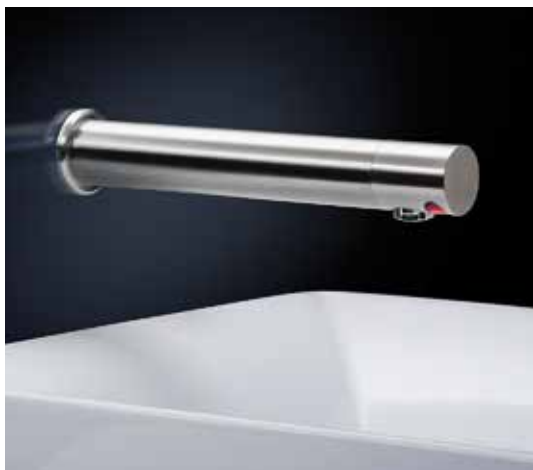

Wall Mounted Long.
Models 42224 and 42235.
Brushed stainless steel.

Wall Mounted Surgeon Scrub. Models 42225 and 42226. Brushed stainless steel. Standard model water flow ceases within 2 seconds after hand removal. Surgeon Scrub model stops 20 seconds after hand removal, providing for basin rinsing.

Zip Touch Free Infrared Taps Specification Table

Deck Mounted Vertical	42220	Deck Mounted Zip Sensor Tap	Mains	150 mm
	42221	Deck Mounted Zip Sensor Tap	Battery	
Deck Mounted Diagonal	42208	Deck Mounted Zip AquaSense Tap	Mains	152 mm
	42211	Deck Mounted Zip AquaSense Tap	Battery	
Wall Mounted Short	42223	Wall Mounted AquaSense Tap	Mains	200 mm
	42222	Wall Mounted Zip AquaSense Tap	Battery	
Wall Mounted Long	42224	Wall Mounted AquaSense Tap	Mains	250 mm Standard
	42235	Wall Mounted AquaSense Tap	Battery	
Wall Mounted Surgeon Scrub	42225	Wall Mounted AquaSense Tap	Mains	250 mm Surgeon Scrub
	42226	Wall Mounted AquaSense Tap	Battery	

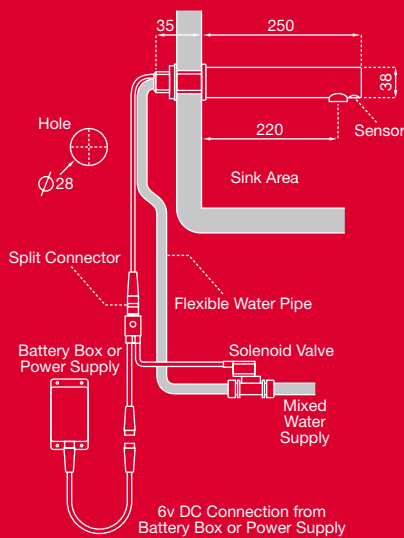

A stainless steel plate allowing for the option of horizontal or vertical plate mounting on less rigid walls is included with all wall mounted models. Wall mounted models provide for easy removal of tap head from its mounting so as to simplify maintenance or replacement without demounting the tap base from the wall.

World-famous HORNE™ Thermostatic Mixing Valves for safer temperature control of baths, showers, and touch-free taps.

- Providing the most reliable way to dispense temperature controlled warm water.
- Gives more precise control than can be achieved by using tempering valves.
- Designed and made by the world leader in TMV technology for over 80 years.
- Supplied complete with inbuilt isolating valves, non-return valves and strainers.
- Simpler to service – easy to remove and replace central valve due to true flat-faced valve connections.
- Quick-remove strainer baskets make cleaning easy without disturbing pipework.
- Slim profile enables the valve to be installed within 50 mm stud walls if required,
- Inlet connections can be rotated to suit existing or preferred pipework layout.
- Due to high flow rate, one valve can cater for one, two or three bathrooms within 10 metres.
(Ten metre maximum pipe length (total pipe) as per AS3500 and AS4032. Refer local regulations.)

Superior performance

The HORNE H1502 TMV valve includes unique features making it safer to operate, simpler to install and easier to maintain in accordance with the stringent regulations governing thermostatic mixing valve maintenance.

Reliable control at low flow rates

The recommended mixed water temperature, 40.5°C to 43.5°C (for adults) and 38.0°C to 40.5°C (for children), is maintained from a minimum flow rate of 2.5 litres/minute through to a maximum flow rate of 48 litres/minute.



The HORNE TMV Model H1502. 42036 Thermostatic Mixing Valve. With 2 isolating valves, 2 strainers, 2 non-return valves.



Safety features

- Quick-react temperature fluctuation feature controls outlet temperature to +/- 2°C.
- Quick-stop anti-scald feature is designed to automatically cut off (thermal shut-off) the hot water within one second should the cold water supply fail.
- Cold-shock fail-safe feature. Should the hot water supply ever fail, the flow of mixed water is cut off and the valve will shut down the flow of cold water to prevent cold shock.
- Mixed temperature is maintained whether the supply pressures are equal or unequal (maximum pressure differential is 20 to 1). The lower of the two supply pressures should be maintained at not less than 12 kPa. This factor is highly important when mains pressure cold water is to be mixed with tank-fed or cistern-fed hot water.
- Cold temperature fluctuation stability feature. Mixed water temperature is maintained when the cold inlet temperature increases, such as with winter/summer variation from 5°C to 30°C.
- Quick-react pressure feature. The valve is designed to operate at a minimum pressure of 12 kPa and a maximum pressure of 600 kPa to cover a broad range of water pressure fluctuations.
- Hot water inlet temperature fluctuation control. Should the water heater temperature control fail, allowing the water temperature at the valve inlet to rise above 60°C, the mixed water output from the valve remains at the set temperature as long as inlet temperature remains less than 85°C.

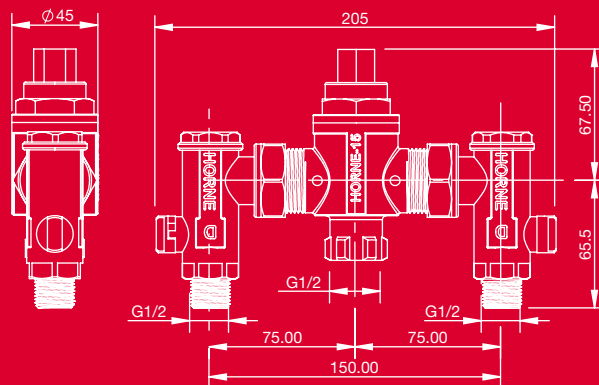

HORNE TMV H1502 TMV Boxes

make TMV installation and maintenance easy.

Standard steel HORNE TMV Box is 370 x 370 x 75 mm.
 Gives technicians rapid access for mandatory maintenance.
 Supplied with lid to cater for in-wall or on-wall fitting.
 Lid options: stainless steel, zinc seal or pearl white.
 Colour-matched covers are available at added cost.
 Hinged lockable lids are made to order in stainless.

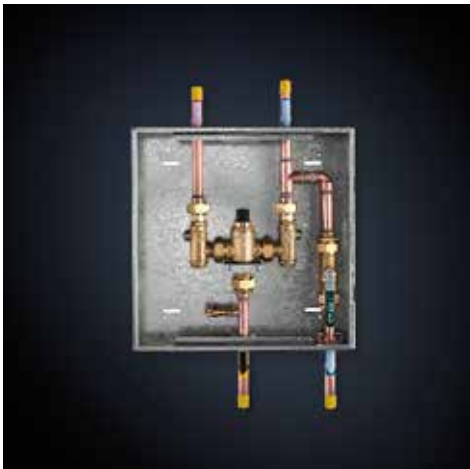

Special 42151 box with bypass, pipes both ends (shown without lid).



Standard 42152 box with pipes at one end (shown without lid).

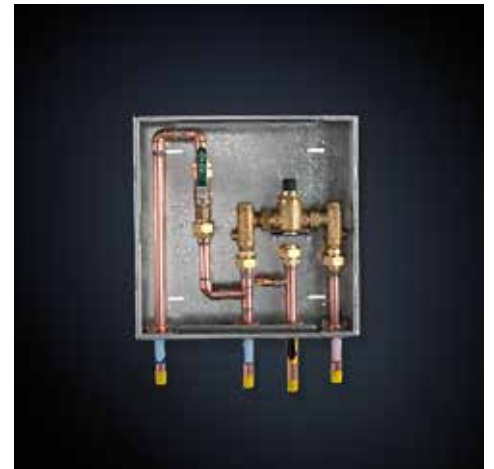

Special 42154 box with bypass, pipes one end (shown without lid).

In-wall box with lid

42155	Stainless steel
42163	Zinc seal unpainted
42171	Zinc seal painted

In-wall box with lid

42157	Stainless steel
42165	Zinc seal unpainted
42173	Zinc seal painted

In-wall box with lid

42156	Stainless steel
42164	Zinc seal unpainted
42172	Zinc seal painted

On-wall box with lid

42162	Stainless steel
42170	Zinc seal unpainted
42178	Zinc seal painted

On-wall box with lid

42160	Stainless steel
42168	Zinc seal unpainted
42176	Zinc seal painted

On-wall box with lid

42159	Stainless steel
42167	Zinc seal unpainted
42175	Zinc seal painted





Zip Touch-Free Hand Dryers

for superior washroom hygiene.

Zip QuickDry™ energy-saving automatic hand dryer.

- High air velocity (320 kph) dries hands super fast.
- Cuts drying time to an average of 12 to 15 seconds.
- Shorter drying cycle reduces energy consumption.
- Unheated air cuts power rating to a thrifty 1.1 kW.

Zip SilentDry™ super-quiet automatic hand dryer.

- Whisper-quiet, warm air hand drying (55 dB @ 1.5 m).
- Perfect for washrooms where acoustics are an issue.
- Also suitable for subdued-light washroom operation.
- Slimline profile, steel grey powder coated alloy case.

Zip Magic Eye® hands-in automatic hand dryer.

- Classic air-recirculating system for energy efficiency.
- Horizontal infra-red sensor field and warm air flow.
- Suitable for installation over reflective bench tops.
- Classic white vandal-resistant polycarbonate case.

Zip SuperDry® for super-stylish hand and face drying.

- Award winning design, for stylish designer washrooms.
- Flip flap to dry hands or face, great for particular users.
- Rapid warm-air hand or face drying, automatic cutout.
- White powder coated vandal-resistant alloy case.



Zip QuickDry. Order Code 20042.



Zip SilentDry. Order Code 20041.



Zip Magic Eye HD101. Order Code 20010.



Zip SuperDry. Order Code 20000. Flap directs air up for face drying.

Zip QuickDry



Zip SilentDry

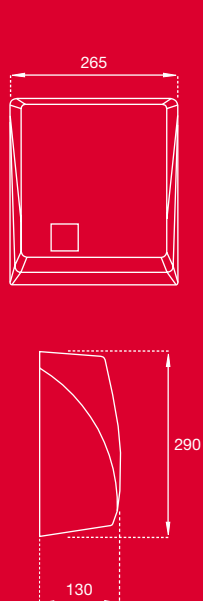

Zip Magic Eye

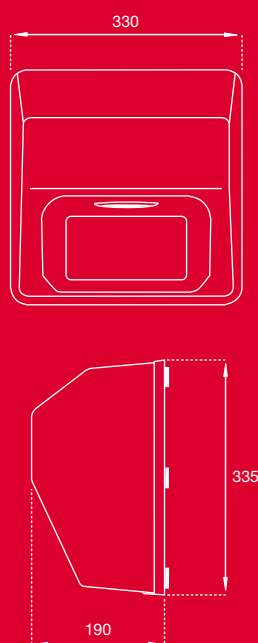

Zip SuperDry

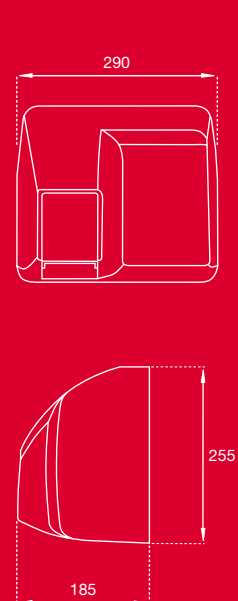

Zip Touch Free Hand Dryers Specification Table

Zip Model	Order Code	Total Rating	Weight kgs	Casing	W x D x H
Zip QuickDry	20042	1.1kW	3.1	Diecast alloy, White Powder Coated	265 x 165 x 270
Zip SilentDry	20041	2.0kW	4.0	Diecast alloy, Steel Grey Powder Coated	265 x 130 x 290
Zip MagicEye	20010	2.2kW	3.25	Tough ABS Polycarbonate, White	330 x 190 x 335
Zip SuperDry	20000	2.2kW	4.0	Diecast alloy, White Powder Coated	290 x 185 x 255

Zip FlushMaster Touch-Free Pan Flushing System

helps you design elegant, effective pan flushing solutions.

- Electronically controlled in-cistern outlet valve.
- Linked to 2 touch-free infrared motion sensors.
- One sensor activates 3.0 litre flush, other 4.5 litre.
- Timer can be set to flush 1 to 9 seconds (1 to 9 litres).
- Sensors activate only when hand is within 50 to 75 mm.
- Sensors can be positioned for easy user access.
- Stainless backplate provided for sensor mounting.
- Supplied with stainless steel cisterns for new sites.
- Also fits 6/3 and 4.5/3 litre flat base existing cisterns.
- Also suits restricted-mobility or grey-water washrooms.

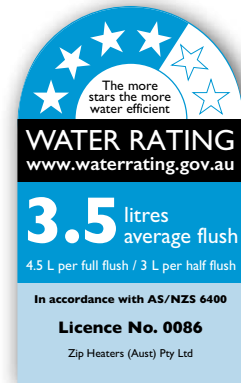

In-wall Cistern

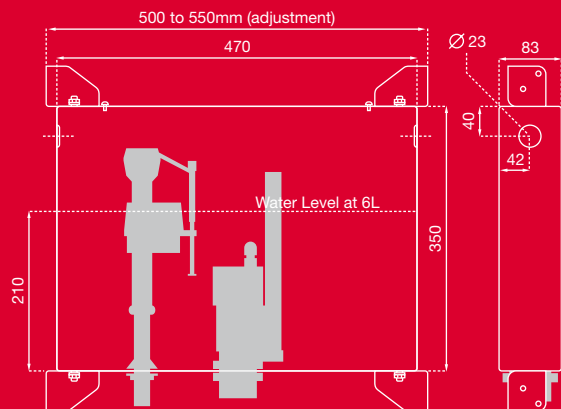

Cistern Access Panel

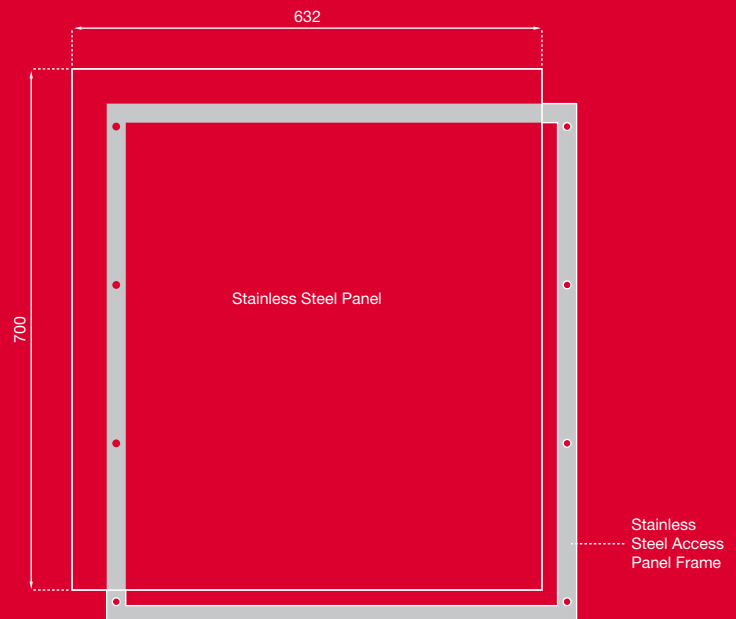

On-wall Cistern

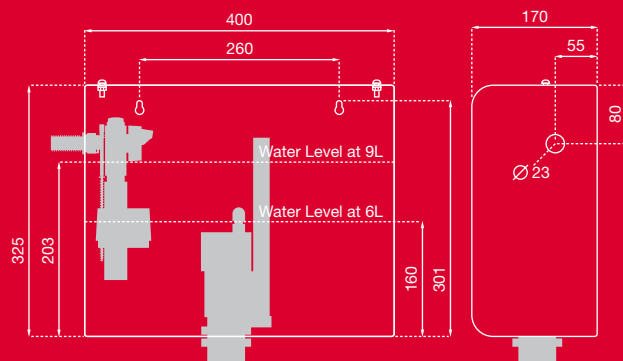

Zip Touch Free Pan Flushing System Specification Table

41097 Zip FlushMaster In-Wall Stainless Cistern supplied with **41096** kit, inlet valve and flush pipe

43099 Zip FlushMaster On-Wall Stainless Cistern supplied with **41096** kit, inlet valve and flush pipe

41099 Stainless steel access panel and fastening frame



Touch-free sensors on 230 x 135 mm stainless steel backplate (supplied)



Sensors and bezels can mount directly to the wall.



Inlet valve supplied with on-wall cistern.



Inlet valve supplied with in-wall cistern.



Outlet valve fitted within each cistern.



Outlet pipe supplied to connect with pan.

1. In-wall stainless steel cistern.
2. Cistern access panel.
3. Control box.
4. Wave sensors.
5. Inlet valve.
6. Outlet valve.
7. Outlet pipe.



Zip Automatic Touch-Free Urinal Flushing System

for single-stall or single-trough urinals.

- Today's most effective single-stall flushing system.
- Four-star WELS water rating, at 1.1 litre per flush.
- Outstanding water savings: soon pays for itself.
- Compact 80 mm ceiling-recessed infrared sensor.
- Narrow beam limits detection area to under 300 mm wide.
- Five second sensor delay beats accidental tripping.
- Adjustable flush cycle to meet your needs precisely.
- Factory set for 12 hour janitor flush when unused.
- Solenoid latching valve supplied with connections.
- Power pack (240/6 volt) connects to 10 amp GPO.

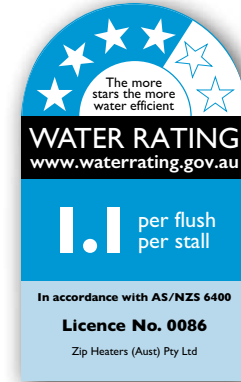

Ceiling recessed sensor.



Latching valve with plumbing connections and Zip Restrictaflow water flow restrictor.



Air breaks for direct injection.



WS005 ceiling sensor.
80 mm dia x 64 mm cutout



Zip Touch-Free washroom systems are a feature of the National Australia Bank, Docklands, Melbourne.

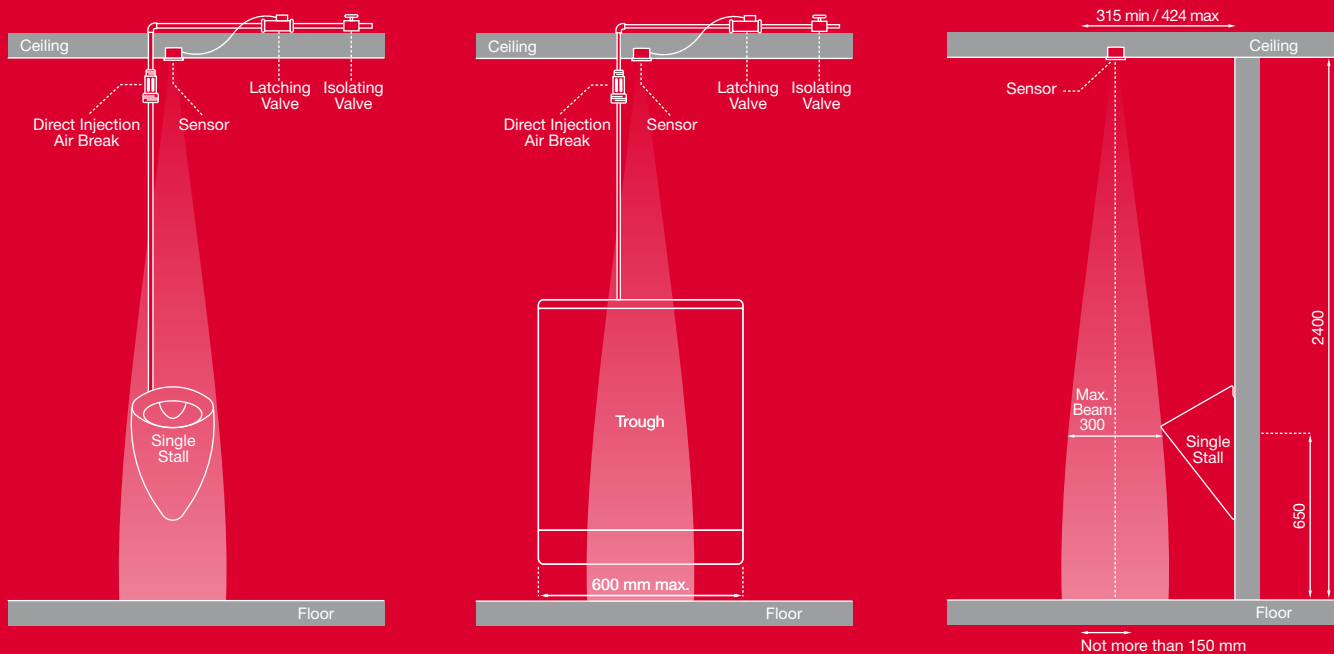

Zip Touch Free Urinal Flushing System Specification Table

42214 Zip FlushMaster Solo WS005 Ceiling Sensor & Solenoid Kit
Accessories:
99024 Zip FlushMaster Direct Injection Air Break Kit 1.0-inch BSP/25 mm
99025 Zip FlushMaster Direct Injection Air Break Kit 1.25-inch BSP/32 mm
99026 Zip FlushMaster Direct Injection Air Break Kit 1.5-inch BSP/40 mm

Zip Automatic Touch-Free Urinal Flushing Systems

for urinal installations of every kind.

Australia's most widely used urinal flushing systems.
 Surface mounted or ceiling recessed infrared sensor.
 Solenoid latching valve supplied with connections.
 Variable flush cycle to allow for site requirements.
 Catering for long slab troughs and wall-hung urinals.
 Battery operated for simple, inexpensive installation.
 Optional power pack connects to 220/240 volt AC power.



WS003 ceiling sensor
 128 mm dia x 105 mm cutout for retrofit.



WS004 ceiling sensor
 80 mm dia x 64 mm cutout.



WS002 surface mounted sensor
 125 x 90 x 60 mm.

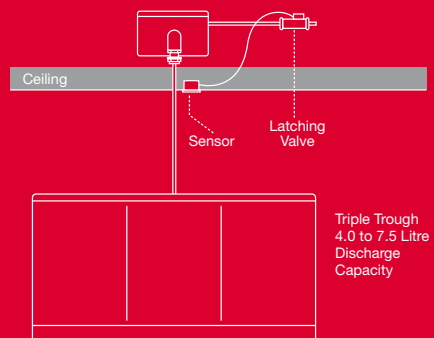
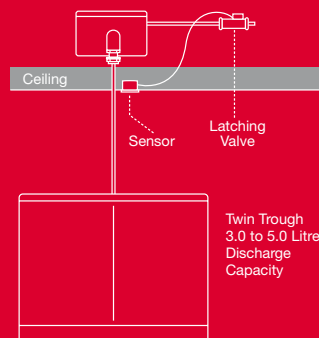
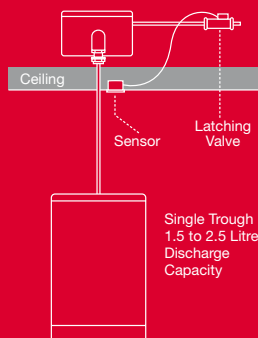
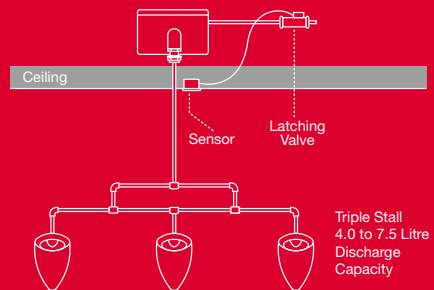
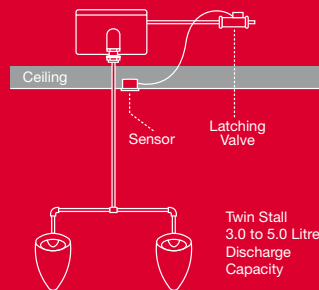
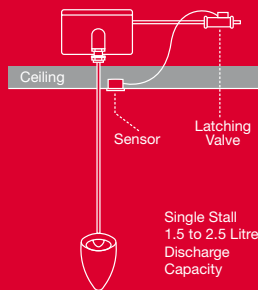



Sydney Cricket Ground features Zip Touch-Free washroom systems.



Latching valve.



Auto-syphon for cistern systems.



Air breaks for direct injection.



Optional power pack connects to 220/240 V AC.

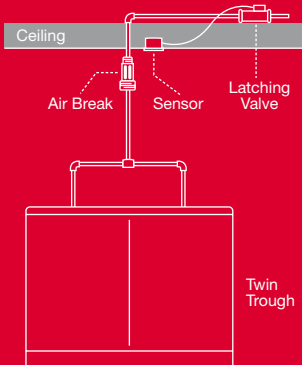
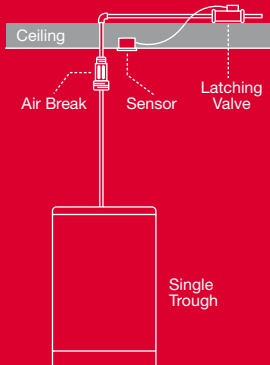
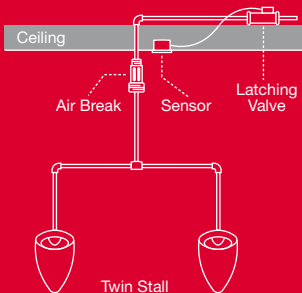
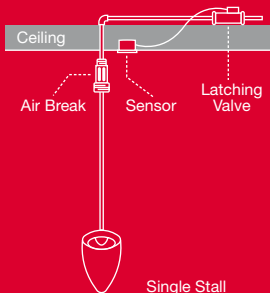

Zip FlushMaster Urinal Systems:

41091 Zip FlushMaster WS004 Ceiling Sensor & Solenoid Kit (with battery)

41095 Zip FlushMaster WS003 Ceiling Sensor & Solenoid Kit (with battery)

40090 Zip FlushMaster WS002 Surface Sensor & Solenoid Kit (with battery)

Accessories:

99021 Zip FlushMaster Auto Syphon Kit (for cistern) 1.0-inch BSP/25 mm

99022 Zip FlushMaster Auto Syphon Kit (for cistern) 1.25-inch BSP/32 mm

99023 Zip FlushMaster Auto Syphon Kit (for cistern) 1.5-inch BSP/40 mm

99024 Zip FlushMaster Direct Injection Air Break Kit 1.0-inch BSP/25 mm

99025 Zip FlushMaster Direct Injection Air Break Kit 1.25-inch BSP/32 mm

99026 Zip FlushMaster Direct Injection Air Break Kit 1.5-inch BSP/40 mm

99031 Zip FlushMaster 240/6 volt Power Pack for WS002/3/4

90874 Zip stainless steel wall mounted cistern to suit 25 mm auto syphon

90875 Zip stainless steel wall mounted cistern to suit 32 mm auto syphon

90876 Zip stainless steel wall mounted cistern to suit 40 mm auto syphon

Zip Touch-Free Washroom Technology is your soundest choice.

Zip touch-free washroom systems are better designed, better built and better backed than any comparable systems.

Zip has established a network of more than 300 trained service providers covering every part of Australia – for installation, repairs or maintenance.

Zip offers you the convenience of ongoing preventive maintenance plans to keep your touch-free washroom technology in first class working order.

All Zip products shown in this publication are backed by a comprehensive 12 month parts and labour warranty. Visit www.zipindustries.com for details.



1800 42 43 44
www.zipindustries.com

Australia

Zip Heaters (Aust) Pty Ltd
(61 2) 9796 3100
www.zipindustries.com

New Zealand

Zenith Heaters
(64 9) 838 8612
www.zenithheaters.co.nz

United Kingdom

Zip Heaters (UK) Ltd
(44) 870 608 8888
www.zipheaters.co.uk

Also in Germany, South Africa,
Hong Kong, Singapore, Thailand,
Taiwan, Philippines, Cyprus,
Middle East and China.